



INDUSTRY EXPERTISE
IN AUTOMATION
AND ELECTRONICS

CONTENTS





COMPANY OVERVIEW 4

TECHNOLOGY EXPERTISE 18

SUBRACKS 28

**INSTRUMENT CASES AND
SYSTEM ENCLOSURES** 94

COMPONENTS AND ACCESSORIES 124

INDUSTRIAL PC 204

SYSTEM PLATFORMS 218

LIST OF ORDER NUMBERS 258

LIST OF TECHNICAL TERMS 268

COMPANY OVERVIEW





CORE COMPETENCE

HEITEC is known for industrial expertise in automation and electronics and offers solutions, products and services in the fields of software, mechanics and electronics. Its customers improve their productivity and optimise their products with the help of HEITEC's state-of-the-art, reliable and economical system solutions. A work force of over 1000 employees at numerous sites worldwide provides high-quality industry skills close to the customer.

Our experienced employees have in-depth, specialised technical knowledge and are also familiar with the specific requirements of industries such as plant and machine construction, energy supply, transportation, aerospace and aeronautics, medical technology, information and communications technology, and measurement and test engineering.

We are always finding new applications for this accumulated knowledge and experience, and thus have access to a wealth of tried-and-tested solutions for a variety of fields. Our design and manufacturing processes are audited and certified to meet the requirements of their respective sectors, guaranteeing the robustness and long service life of our products.

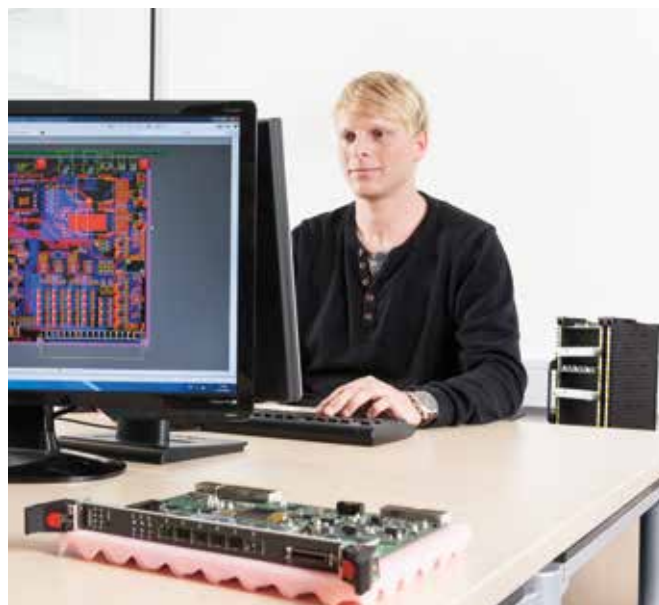

COMPANY OVERVIEW

INDUSTRY EXPERTISE IN AUTOMATION AND ELECTRONICS



HEITEC offers innovative automation solutions for both newly planned projects and system modernisations (retrofits) in plant and machine construction, as well as in production – from planning to all-inclusive implementation.

AUTOMATION

Faster to networked production

The solution portfolio from HEITEC's Business Unit Automation includes measurement and test engineering, robotics, complete production systems, and energy technology. As experts in automation and information technology, we can offer solutions for rapid production networking under the HEITEC 4.0 banner:

From digital plant and process planning to virtual commissioning and the monitoring of plants and manufacturing processes: our solutions make it possible to develop a smart factory with adaptive machines and systems, as well as decentralised manufacturing controls.

Practical, step-by-step introduction of Industry 4.0

- Optimisation of processes, plant and quality
- Shortened commissioning periods
- Reduced throughput times
- Reliable planning thanks to real-time data
- Optimised material and component consumption
- Improved construction quality





What is it that makes HEITEC electronics so special?

Three areas of expertise – design, chassis technology and manufacturing – that work together smoothly to meet the increasingly complex requirements of our customers:

Design: This is based on our 30-years history as an expert service provider in the area of electronic design.

Chassis technology: A stable, modular system of chassis technology and an extensive library of proven hardware, software and mechanical building blocks from Rittal's former portfolio of electronic packaging systems.

Manufacturing: Since we know how important it is to manufacture products flexibly and yet cost-effectively, particularly when it comes to low and medium module quantities, our portfolio is rounded out by the right manufacturing capacities to meet your needs.

ELECTRONICS

From idea to product

Our comprehensive portfolio helps you achieve your system solution more swiftly, cost effectively, flexibly and safely – from the module to the board design, all the way to the complete chassis. Thanks to our extensive experience from many projects, with differing levels of added value in a range of demanding industries and for many different target applications, we understand your specific requirements and reflect them in our solutions.

We have a comprehensive library of proven hardware, software and mechanical building blocks that we can draw on for every solution we create.

Expertise in tailor-made solutions

- Customer-specific products and solutions implemented more swiftly, safely, and cost-effectively
- Products perfectly optimised thanks to in-depth knowledge of the industry – including for demanding, regulated markets
- The same high design and manufacturing quality for both small and large series
- Optimised products with a large test depth
- Ongoing development of products throughout the entire lifecycle

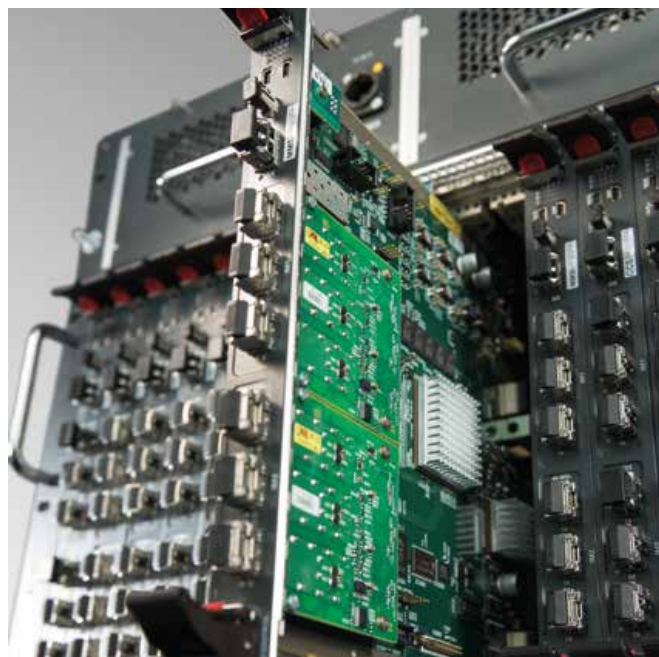

COMPANY OVERVIEW

EXPERTISE IN SOFTWARE, MECHANICS AND ELECTRONICS



INDUSTRY EXPERTISE: WE FOCUS ON THE APPLICATION

Our employees not only have profound technical specialist knowledge, they also have experience in numerous key industries such as industrial automation, aerospace and aeronautics, medical, energy, communications and transportation technology.

This means we have an in-depth understanding of your requirements – even if these are not always explicitly formulated.

INDUSTRIAL CONTROL



ENERGY



DEFENSE & AEROSPACE



MEDICAL



COMPANY OVERVIEW

EXPERTISE IN SOFTWARE, MECHANICS AND ELECTRONICS

QUALITY IS AT THE CORE OF OUR ACTIVITIES

Our products and services are based on established and certified processes, methods, and quality management systems. Additionally, we have industry-sector-specific process know-how.

Our skills in design and manufacturing the appropriate components and systems are confirmed by a range of certificates.



TRANSPORTATION



MEASUREMENT AND TEST



INFORMATION AND COMMUNICATION



Certifications, Standards, Guidelines
ISO 9001
EN ISO 13485
EN ISO 14971
EN 60601
EN 62304
DO-160, DO-178, DO-254
NSQ 100
EN 50155
ETSI
NEBS

COMPETENCE AND KNOW-HOW

Development of customer-specific systems

Manufacturing and testing of electronic products for batch sizes starting at quantity 1

Professional chassis technology from standard products to system solutions

We help you build the best system solutions

Our experience ranges from defining system architecture to developing and implementing individual components, through to manufacturing and integrating entire systems, throughout the entire life cycle of the systems in question. Coordinated processes guarantee excellent quality and provide the flexibility to adapt rapidly when new application requirements call for it. Our experienced employees have in-depth technical knowledge in their fields and understand the industry-specific requirements. Our design and manufacturing processes are coordinated with these requirements, and are audited and certified.

Our solutions minimize your design and production risks and can be applied to your product at lower cost and on time. We look after your products throughout their entire lifecycle. We strive to offer you the best system solution every time, one that will give you a lasting competitive edge.

Everything comes with the same quality objective – whether it's for a “simple” board or for a more complex system comprising hardware, software and chassis technology.

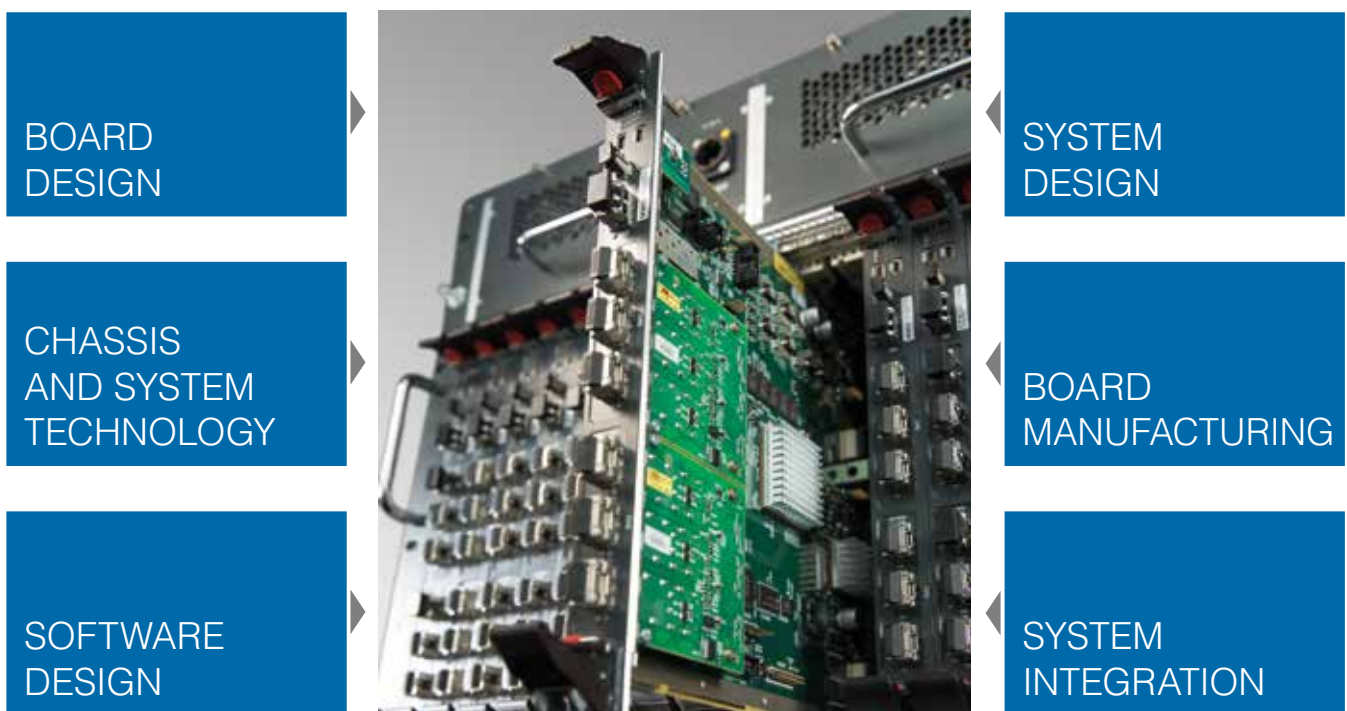



From idea to product: Expertise in tailor-made solutions

To turn your electronic product, which is often not more than a concept at first, into reality, you need reliable partners. We know all the steps and processes needed to make the transition from system design to prototyping, the necessary tests and inspections, through to series production. We know how important it is for design, manufacturing and service interfaces to mesh together. We create targeted industry applications with all the necessary certification. Whether it's electronic modules with the associated firmware, chassis systems in rail-mounted format or any kind of industrial PC for complex, high-availability systems, our teams will be there even after the project is completed to offer consulting, change management, after-sales service and long-term availability. HEITEC can provide everything from a single source – you maintain an overview of your projects and we provide the support and coordinate all the processes.

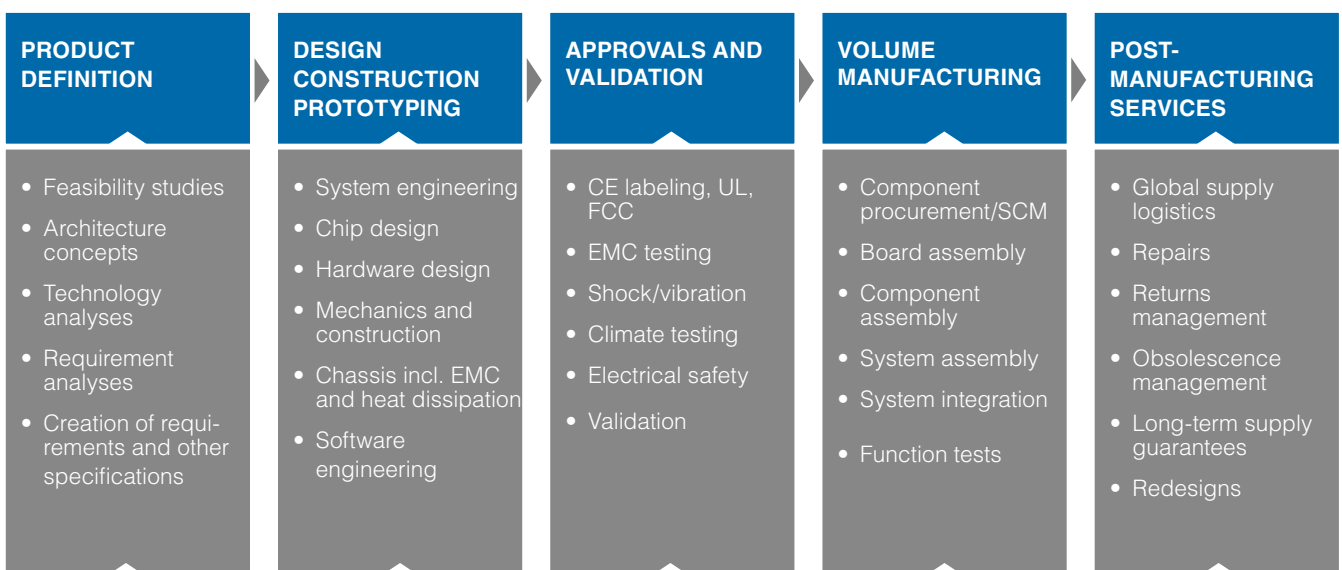

Use of building blocks:

- Library elements (software, mechanics and electronics)
- Wealth of experience from prior projects
- Chassis technology components and system platforms



**YOUR PARTNER FOR ELECTRONIC CHASSIS
AND SYSTEMS**

The current product portfolio offered by HEITEC AG in the area of electronic packaging systems and chassis is based originally on the corresponding product range from Rittal. Starting in early 2010, HEITEC has been steadily taking over this product range from Rittal and integrating it into its current range of products and services – constantly refining and expanding it.

2010

PRODUCT BRANDS



INTERNATIONAL SALES

**STANDARD CATALOG PRODUCTS
AND PRODUCT LINE OWNERSHIP**

**CUSTOMER-SPECIFIC
ELECTRONIC PACKAGING SYSTEMS
AND COMPONENTS**





CONSISTENCY AND CONTINUITY

HEITEC not only maintains the original Rittal part numbers but guarantees consistency, product longevity, supply chain security and continuous enhancement of its broad product range.

HEITEC was originally able to guarantee global customer support thanks to its partnership with Rittal subsidiaries abroad. Today, HEITEC has its own global network of sales partners that ensure customer support right around the world.

2013

2015

2016



In 2010, HEITEC took over Rittal's customer-specific products, followed by the complete product portfolio for electronic packaging systems, product line ownership and national sales in 2013. Starting in 2015, HEITEC began expanding its own global sales network of distribution and system integration partners in all key industrialised nations around the world. Lastly, in 2016, all product names and brands were changed over to the HEITEC range.

COMPANY OVERVIEW

PRODUCTS AND SERVICES

HEITEC's comprehensive portfolio of standard products and individual solutions gives you professional chassis technology – we “package” your electronics to suit your applications, every time.

We are constantly expanding this broad spectrum of chassis components, subracks, instrument cases and system enclosures as well as system platforms. We also offer individual adaptations to these products, in addition to special, customer-specific developments.

Selecting the right chassis technology is the basis for an efficient end product. Our skills lie in our many years of experience covering everything from mechanical

design to ensuring electromagnetic compatibility and effective heat dissipation concepts for highly complex systems. If you would prefer to take responsibility for the bulk of the system integration process yourself, you can order individual components, pre-assembled components or system enclosures from us to suit your requirements. If you prefer pre-integrated or fully integrated solutions, incorporating your own hardware and software if needed, we can provide a complete service through to a customer-specific system solution.

We support you in exactly those areas that match your business model best.

From components through to the complete system

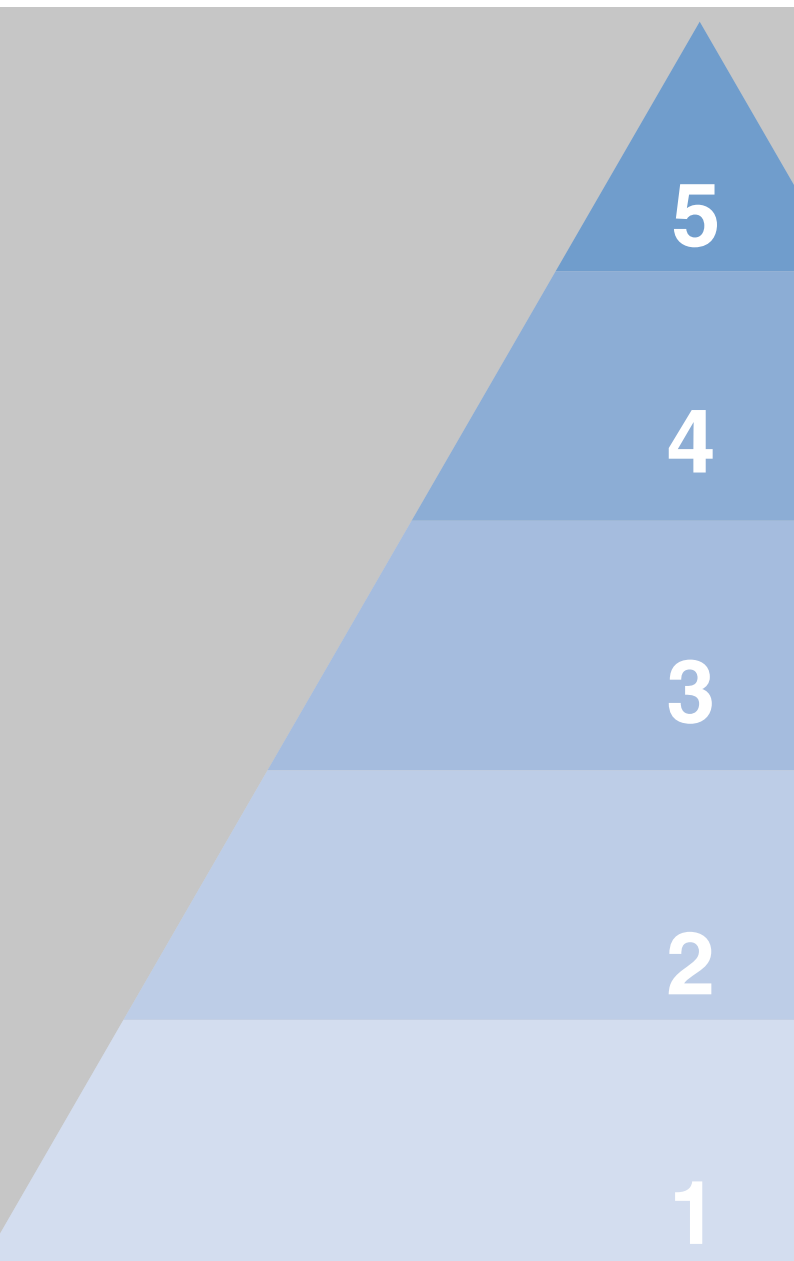

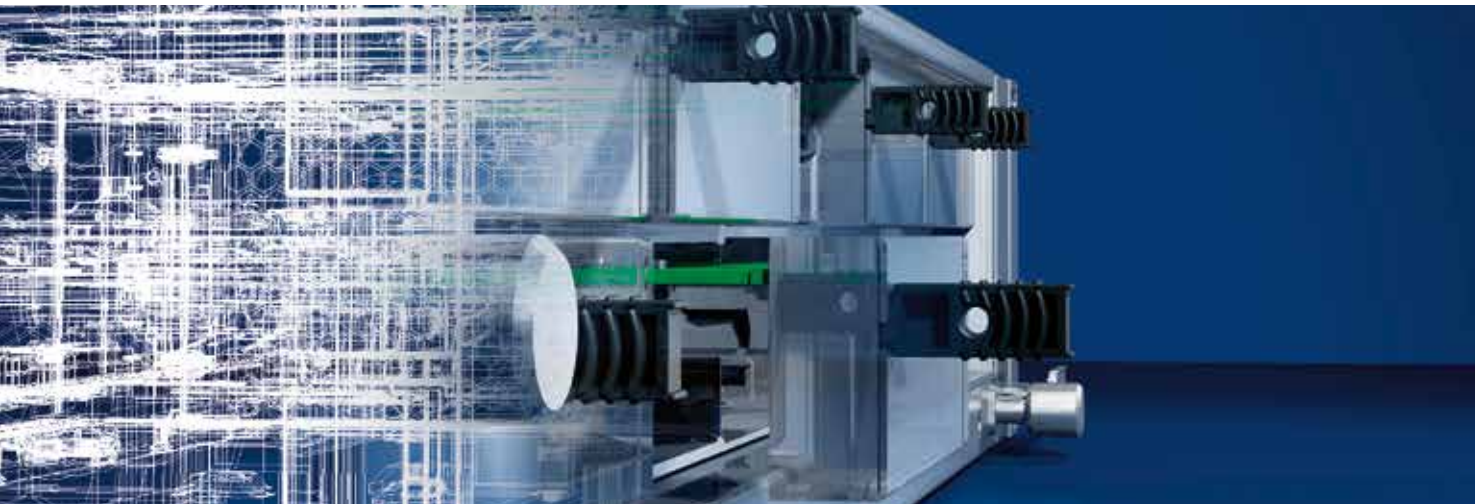

SYSTEM SOLUTION

Ready-to-use, fully integrated with hardware and software

PRE-INTEGRATED SYSTEMS

Partial or full integration of active modules and/or software

SYSTEM PLATFORMS

Chassis incl. ventilation/cooling, power supply, backplane

CHASSIS

Subracks, instrument cases and system enclosures, industrial PC, box-type plug-in units

COMPONENTS

Individual components and accessories
e.g. handles, front panels, EMC components

COMPANY OVERVIEW

PRODUCTS AND SERVICES

HEITEC is more than just a manufacturer of high-quality chassis solutions – it offers much more besides. Our highly flexible range of services maximizes customer benefit, even when low unit quantities are involved.

It doesn't matter if you want your preferred components assembled to suit your requirements, or if you need our experienced manufacturing staff to assemble all the mechanical, electrical and electronic components. We also strive to offer a long-term delivery capacity and delivery times to suit customer requirements.



Configuration

The wide range of variations available for chassis products means they can be combined easily and in many different ways

- Online configuration using the HEITEC subrack configurator
- Easy-to-follow product tables make it easy to put your desired product together

Assembly

HEITEC production facilities offer the latest in certified assembly and manufacturing options

- Skilled and reliable assembly, including final inspections, even for small unit quantities
- Assembly of individual parts, wiring, or even complete system configuration – depending on what the customer needs

Logistics







HEITEC's experienced logistics team can develop individual logistics plans to suit customer requirements

- Holding stocks of critical components for your project means HEITEC can guarantee a long-term delivery capacity
- HEITEC is a known Consignor that delivers worldwide

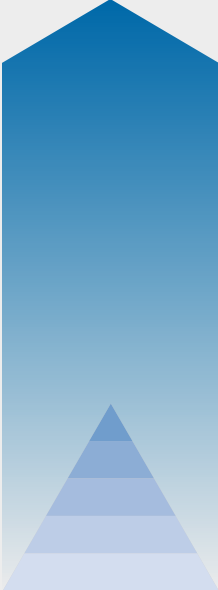
Customised adaptations and system solutions

HEITEC can provide adjustments from single-part level through to customer-specific system solutions

- Front panel processing, special colors for chassis and decorative elements
- Design and manufacturing of individual, ready-to-use system solutions

	Individual		19-inch format
Ready-to-use system with integrated hardware and software, e.g. → Mobile charging station for cars			
Subracks/chassis, e.g. → Small chassis → Din rail chassis			
Customised spare parts processing, e.g. → Front panel adaptations			



Besides a multitude of standard products in this catalogue, we provide individual, tailor-made solutions.

Be it customer specific front panels – drilled, milled or printed according to your requirements, be it subracks, system enclosures or system configurations adapted to your application:

We create the appropriate product for you.

Please do not hesitate to contact our specialists.



TECHNOLOGY EXPERTISE



Overview of standards

Designs for electronic systems (dimensions for 19-inch design)

IEC 60297-3-100	Basic dimensions of front panels, subracks, rack-mount systems, racks and cabinets
IEC 60297-3-101	Subracks and assembly modules
IEC 60297-3-102	Injector/extractor handle
IEC 60297-3-103	Keying and guide pin
IEC 60297-3-104	Connector dependent interface dimensions of subracks and assembly modules
IEC 60297-3-105	Dimensions and layout of 1 U high rack-mount systems
IEC 60297-3-106	Adaptation dimensions for subracks and rack-mount systems applicable with metric cabinets or racks in accordance with IEC 60917-2-1

Environmental conditions for designs as per IEC 60917, IEC 60297

DIN EN 61587-1	Climatic and mechanic tests and safety aspects for cabinets, racks, subracks and rack-mount systems
DIN EN 61587-2	Seismic tests for cabinets and racks
DIN EN 61587-3	Electromagnetic shielding performance tests for cabinets and subracks
VG 95373, part 15	Electromagnetic compatibility of equipment Part 15: Measuring method for coupling and shielding

Safety

IEC 60950-1	Information Technology Equipment – Safety Part 1: General requirements
-------------	---

Rail

EN 50155	Electronic equipment used on rail vehicles
----------	--

TECHNOLOGY EXPERTISE

19-INCH PACKAGING SYSTEM

19-inch technology: dimensional relationships

The 19" packaging system is based on internationally applicable dimensional standards that describe the coordinated, modular system structure. The various parts making up the IEC 60297 series of standards describes the mechanical structure of the system.

The objective of these provisions is to ensure that different devices and modules from all potential manufacturers can be combined and substituted without difficulty.

The 19" packaging system is now used in almost every area of industrial electronics: transportation, energy, IT and industrial control.

More specifically, the 19" packaging system can be divided into the following four levels:

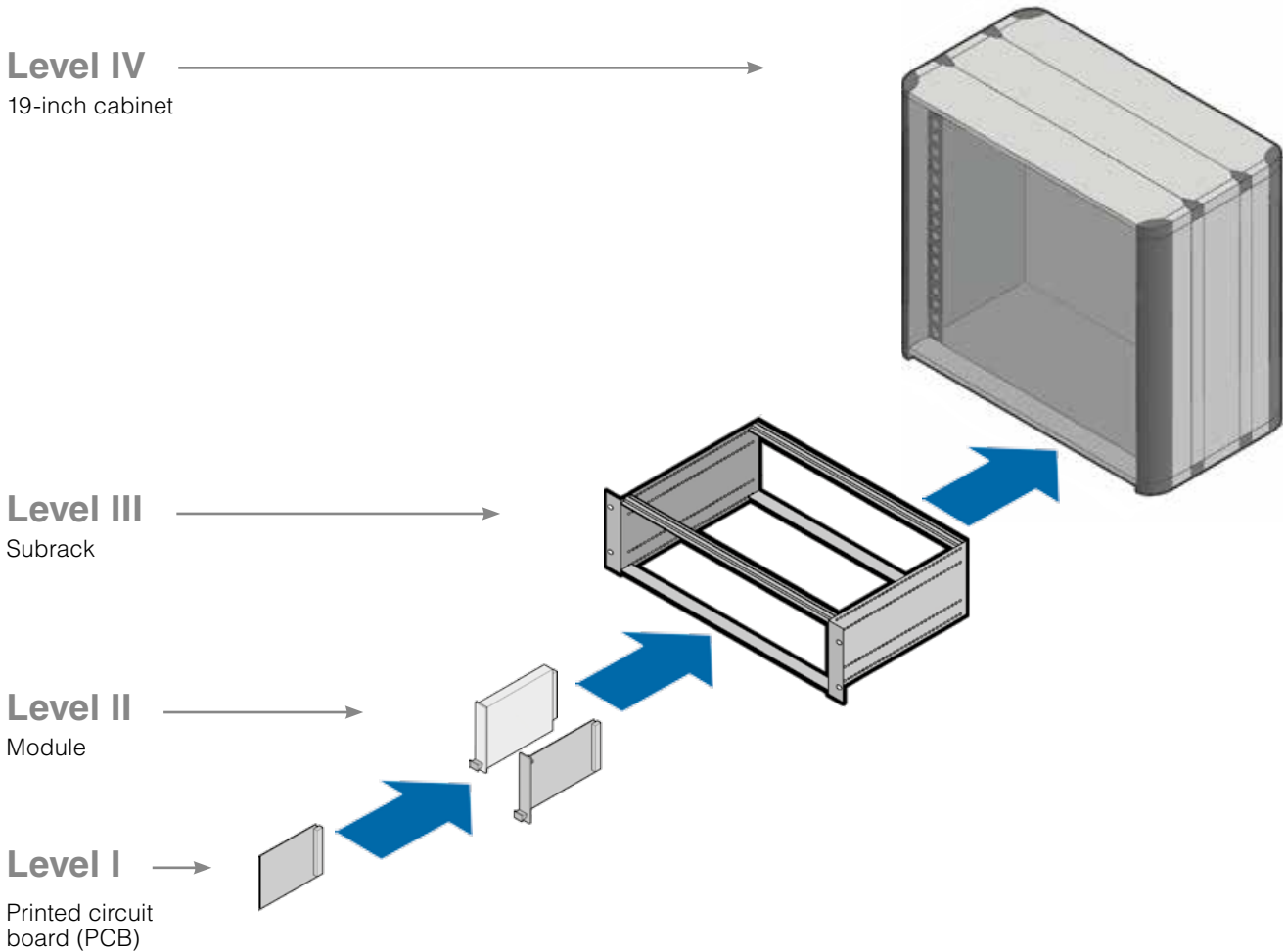

Level 1: Printed circuit board

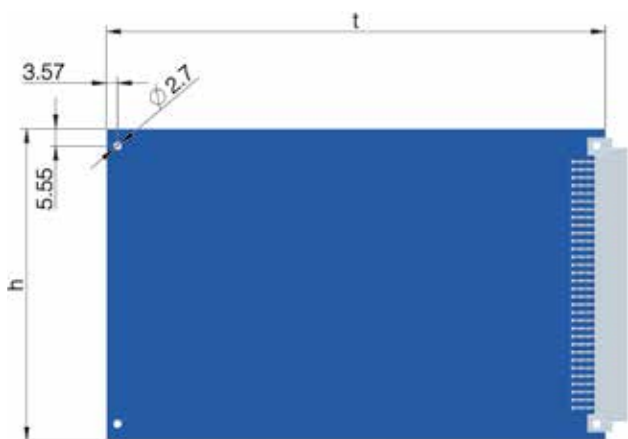

Subrack height	PCB height h - 0.3 mm	PCB depth (mm) t - 0.3 mm			
		100 mm	160 mm	220 mm	280 mm
3 U	100 mm	-	x	x	-
6 U	233.35 mm	-	x	x	-
9 U	366.70 mm	-	x	x	-

x most common dimensions

The PCB dimensions are defined on the basis of the eurocard format and are set forth in standard IEC 60297-3-101. Starting from a height of 100 mm and a depth of 160 mm as the basic dimensions, the height increases by multiples of one height unit (1 U = 44.45 mm) and the depth by multiples of 60 mm.

The table above shows the PCB formats most commonly used.

PCBs are generally 1.6 mm thick. Different, higher values must be coordinated between the user and the manufacturer to arrange suitable guide rails. Standard subrack depths are arranged in accordance with PCB depths of 160, 220 and 280 mm.

Level 2: Module

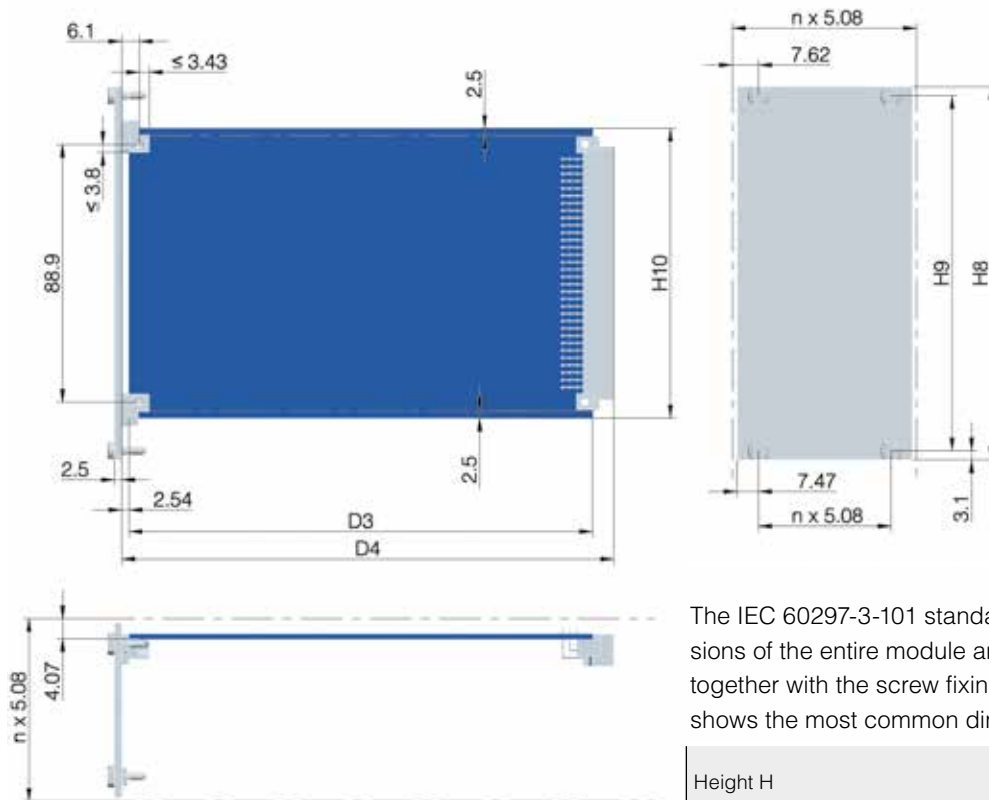

The IEC 60297-3-101 standard also describes the dimensions of the entire module and associated front panel, together with the screw fixing points. The following table shows the most common dimensions.

Height H				Depth D			
Height units	3 U	6 U	9 U	Depth units			
H8 ± 0.15	128.55	261.9	395.25	D1 ± 0.5	175.6	235.6	295.6
H9 ± 0.2	122.5	255.85	389.2	D3 - 0.3	160	180	220
H10 +0 -0.3	100	233.35	366.7	D4 ± 0.4	169.93	229.93	289.93

TECHNOLOGY EXPERTISE

19-INCH PACKAGING SYSTEM

Level 3: Subrack

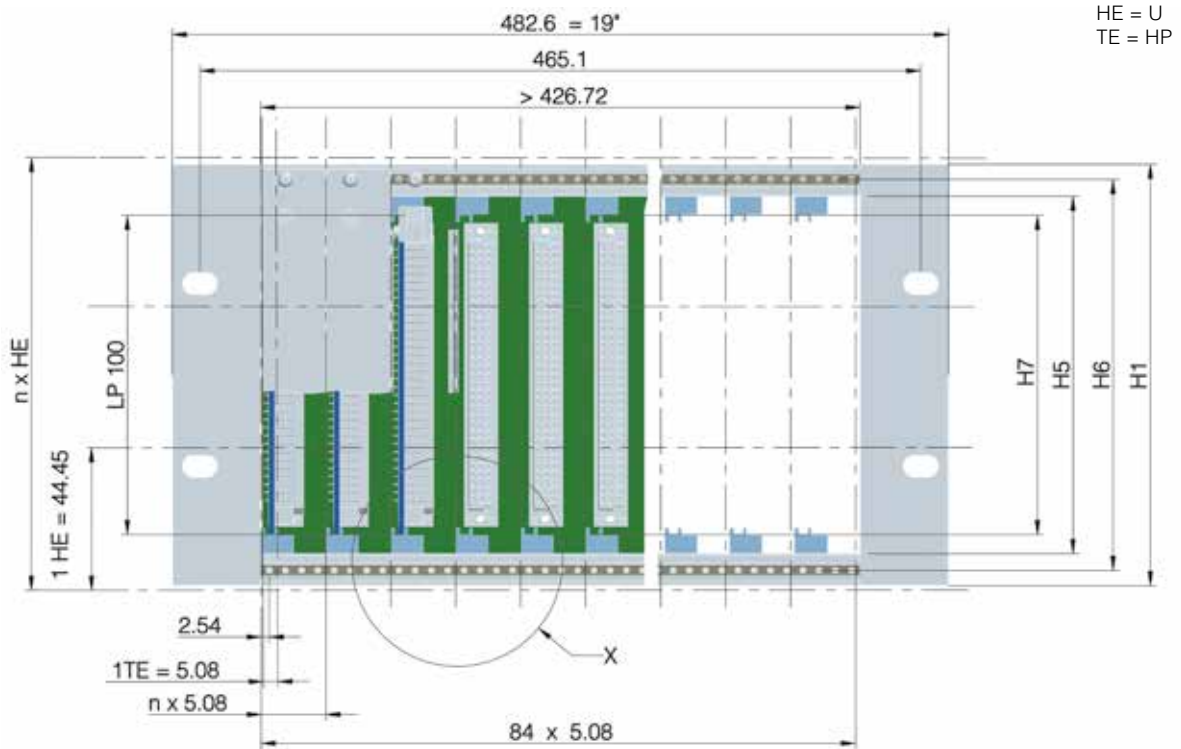

Height units	3 U	6 U	9 U
H1 ± 0.4	132.55	265.90	399.25
H5 ≥	112.00	245.35	378.70
H6 ± 0.2	122.50	255.85	389.20
H7 + 0.5 -0	100.20	233.55	366.90

DIN EN 60297-3-101 provides a figure of 482.6 mm (19 inches) for the width of the subrack front.

The maximum subrack height is given as a multiple of one height unit (1 U), or 44.45 mm. This ensures that the subrack height is coordinated with the height of the plug-in units used. Typical sizes are 3 U, 6 U and 9 U (refer to table).

The installation space for the modules is divided into horizontal pitch units (HP) of 5.08 mm (0.2 inch), or 84 HP for a subrack width of 19 inches.

Level 4: 19-inch cabinet

HE = U

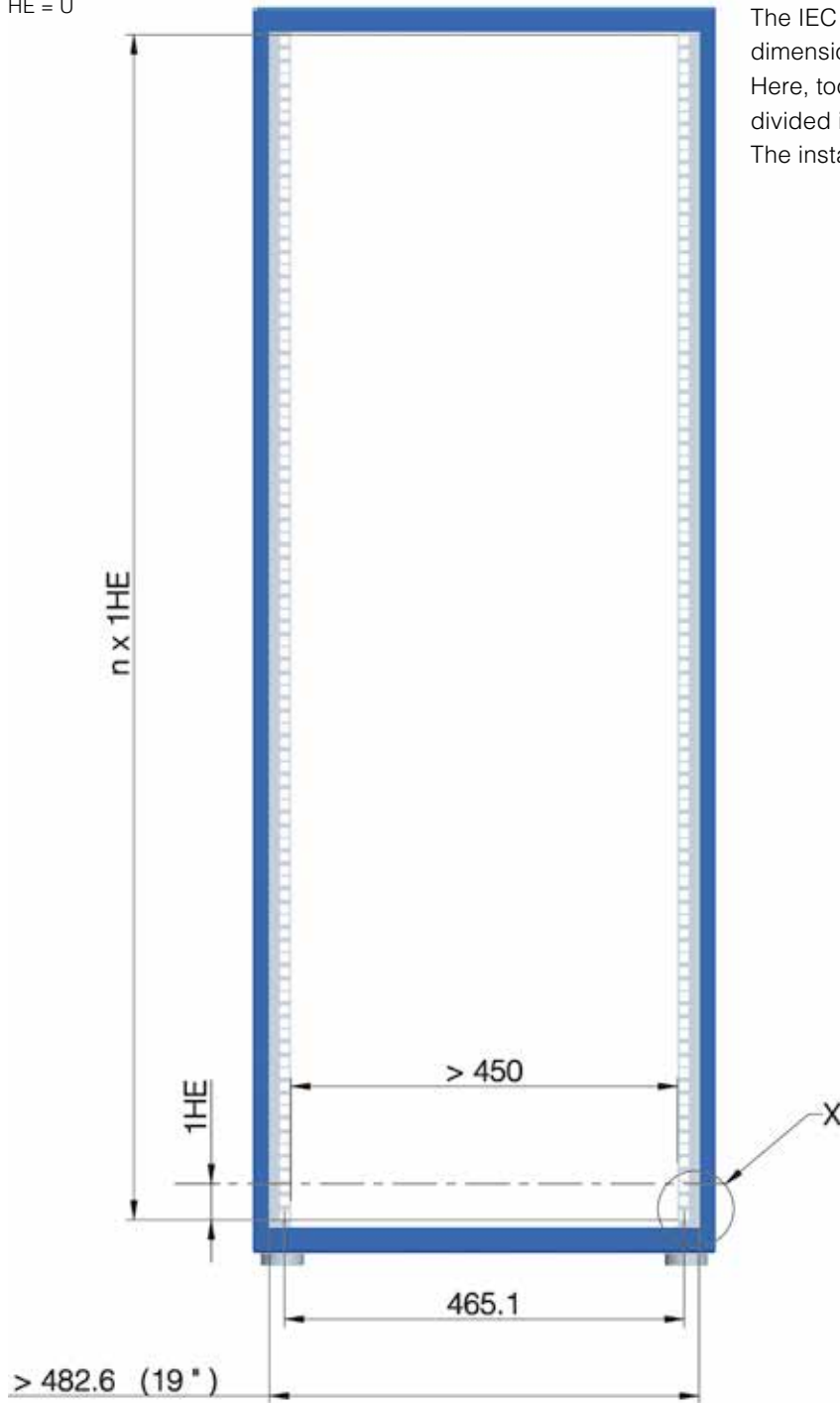

The IEC 60297-3-100 standard describes the basic dimensions of the 19-inch cabinet. Here, too, the space available to fit the subracks is divided into multiples of 1 U. The installation space must be at least 450 mm wide.

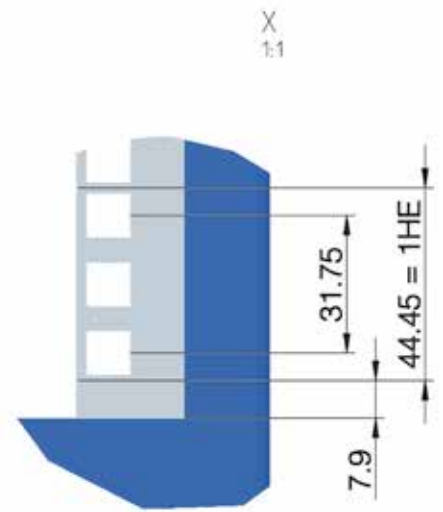

TECHNOLOGY EXPERTISE

19-INCH PACKAGING SYSTEM

Backplane

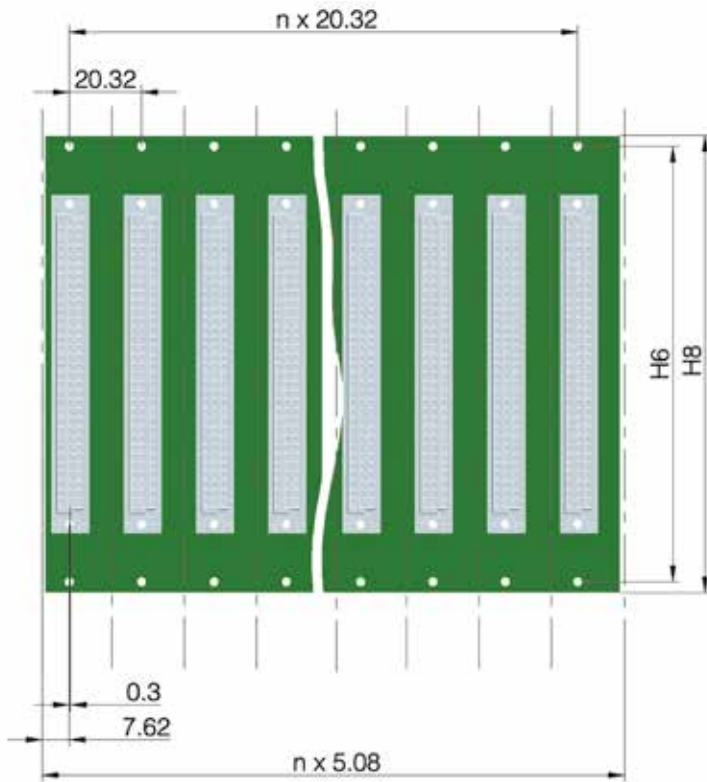

Backplane with plug connector as per
DIN 41612/IEC 60603-2 and IEC 61076-4-113

Typical application: VME/VME64 systems

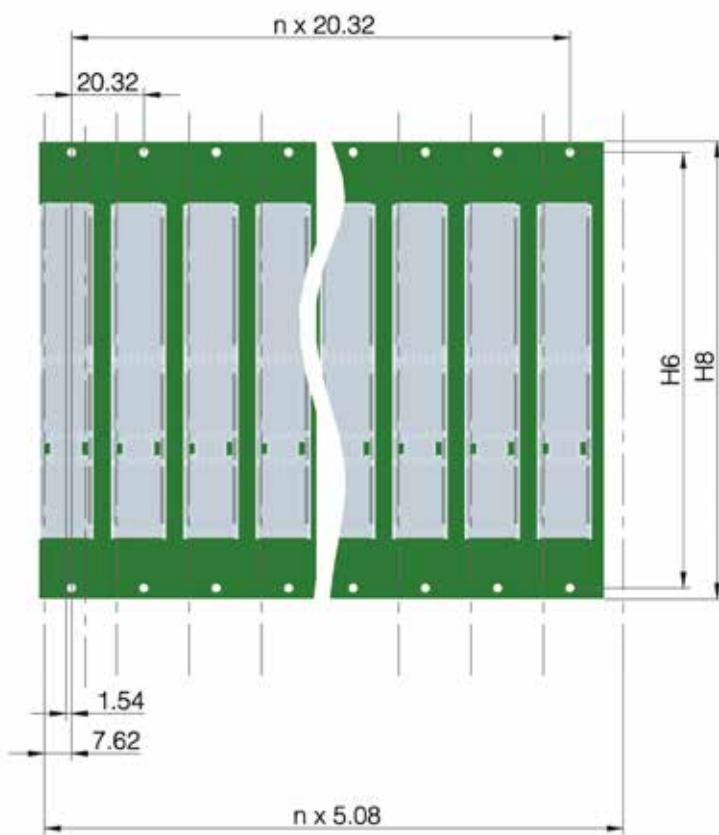

Backplane with plug connector as per
IEC 61076-4-101

Typical application: CPCI systems

The IEC 60297-3-104 standard describes the dimensions of the backplanes for the most common height variations (refer to table).

Height units	3 U	6 U	9 U
H6 ± 0.2	122.50	255.85	389.20
H8 ± 0.15	128.55	261.90	395.25

IP protection levels – chassis protection classes (IP code)



1st IP number

2nd IP number

Protection against solid objects

0	No protection
1	Protected against solid objects over 50 mm in diameter
2	Protected against solid objects over 12.5 mm in diameter
3	Protected against solid objects over 2.5 mm in diameter
4	Protected against solid objects over 1.0 mm in diameter
5	Protected against dust (limited ingress, no harmful deposit)
6	Totally protected against dust

Protection against contact

0	No protection
1	Protected against contact with back of hand
2	Protected against contact with fingers
3	Protected against tools
4	Protected against wires
5	Complete protection against contact
6	Complete protection against contact

Protection against liquid

0	No protection
1	Protected against vertically falling drops of water, e.g. condensation
2	Protected against direct sprays of water up to 15 degrees from vertical
3	Protected against sprays up to 60 degrees from vertical
4	Protected against water sprayed from all directions
5	Protected against low-pressure jets of water from all directions
6	Protected against strong jets of water
7	Protected against the effects of short-term immersion
8	Protected against long periods of immersion

TECHNOLOGY EXPERTISE PROTECTION REQUIREMENTS

Electromagnetic compatibility (EMC)

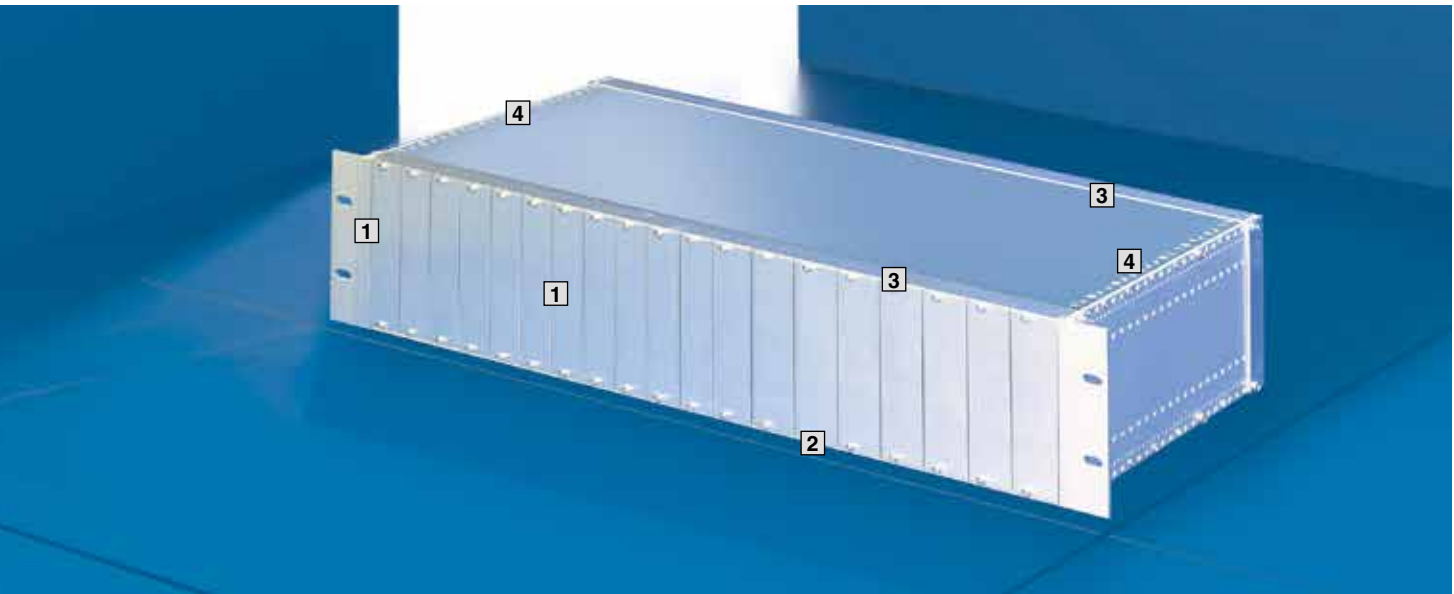

- 1 EMC gaskets, vertical
- 2 EMC gaskets, horizontal
- 3 EMC gaskets for cover plates
- 4 Mounting blocks

EMC (electromagnetic compatibility) refers to the ability of an electrical device to function satisfactorily in its electromagnetic environment without influencing this environment more than is admissible. These requirements were taken into account when developing the HEITEC subracks.

They are made entirely from metal and coated with a conductive surface finish. Stainless steel EMC gaskets ensure a conductive connection between the separate parts.

Testing of measurements of the shielding effectiveness of empty chassis is based on DIN EN 61587-3 or military standards, e.g. MIL STD 285 (US) or VG 95373 Part 15 (GER).

International EMC standards are published mainly by IEC (International Electrotechnical Commission) and CISPR (International Special Committee on Radio Interference).

Key series of EMC standards with global importance: IEC 61000

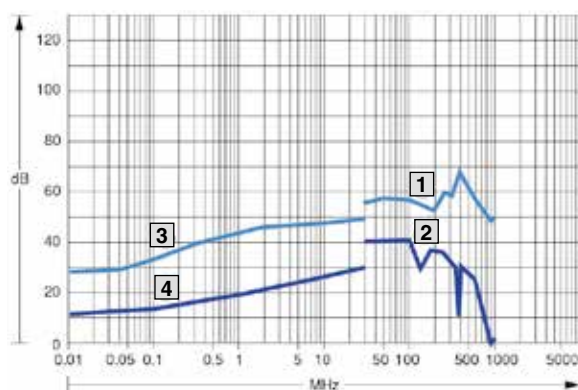

- MHz = frequency
- dB = HF attenuation
- 1 E-Field = electric field (V/m)
EMC chassis
- 2 E-Field standard chassis
- 3 H-Field = magnetic field (A/m)
EMC chassis
- 4 H-Field standard chassis

The above diagram shows the extent to which EMC shielding influences the attenuation of the electromagnetic field. The attenuation of a standard chassis with no suitable EMC components is thus much lower than that of a HeiPac Vario EMC subrack.

Of particular interest is the shielding factor provided by the attenuation.

HF attenuation (dB)	Shielding (%)
6	50
20	90
40	99
60	99.9

Screws

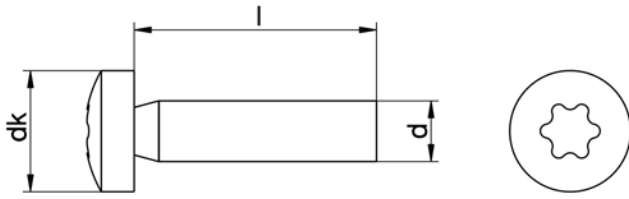

Screws are used to achieve a tight connection between two or more components. They form part of a screw gear consisting of two standardised, paired components. Friction on the wedge-shaped thread under load prevents the screws from coming loose.

Examples

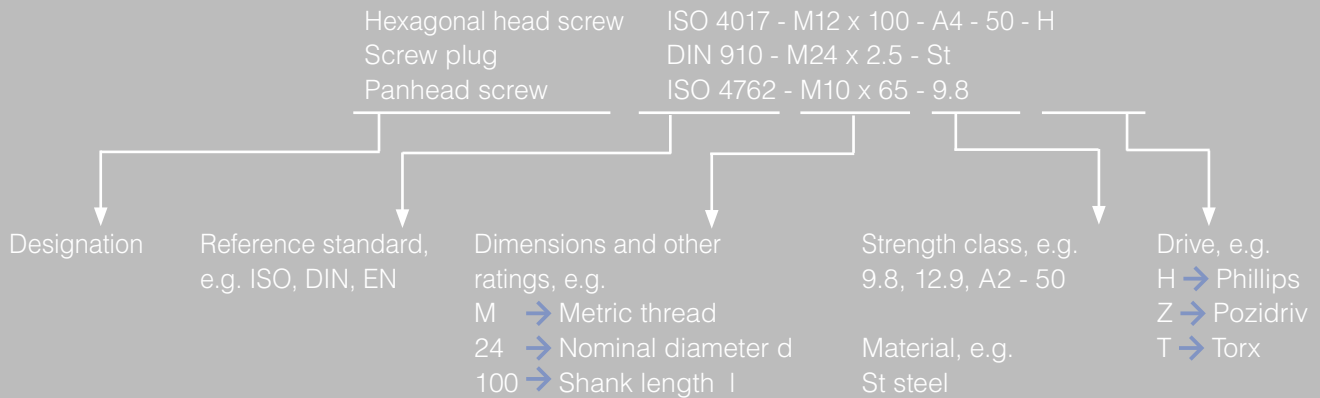

Nuts

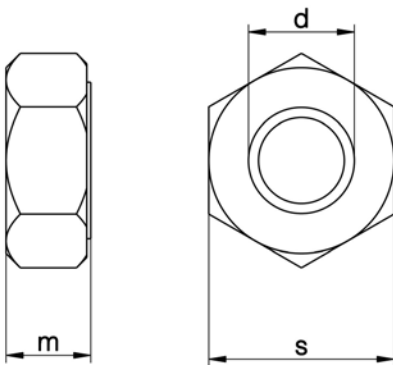

Nuts are the counterpart to the screws. They have a standardised inside thread that matches the thread of the screw. The prismatic outside contour is shaped to accommodate a wrench, which is used to tighten the nut. In terms of dimensions, the height of a nut is approximately half the width across the flats.

Examples

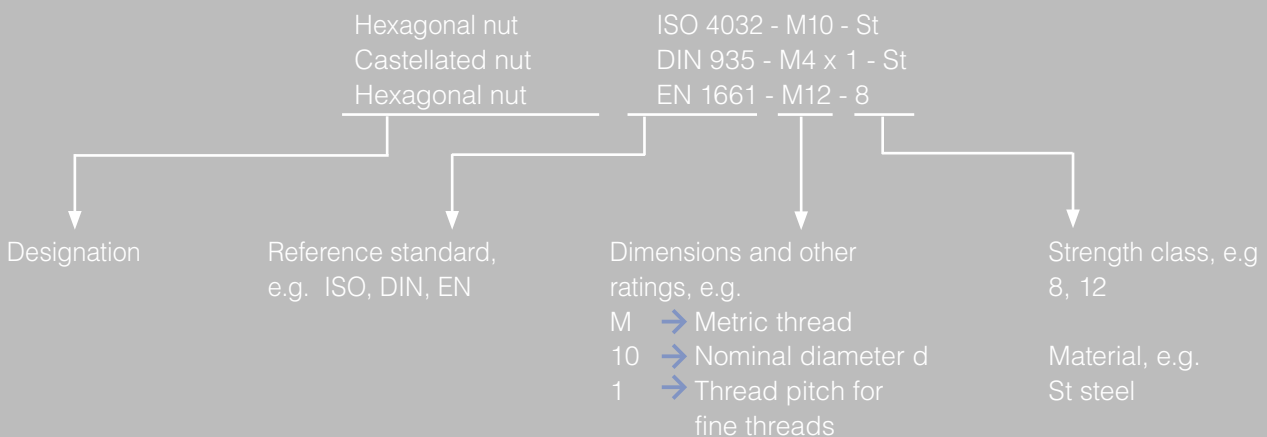

HeiPac subrack systems

A minimum of components – a multitude of applications

SUBRACKS



The modular concept of HeiPac subracks facilitates a wide range of application options with a minimum of components.

All HeiPac subracks are based on the same horizontal rails and system components. The difference lies in the design of the side panels and installation options. The only exception is the HeiPac EASY subrack system, which is based on a horizontal rail system of its own. All front systems can be universally applied for all subrack families.

The subracks are shock and vibration-tested and comply with IEC 60 297-3-101, 102 and 103.

HeiPac Vario



Universal 19" subrack system

- Varied size range
- Flexible design options
- A wealth of accessories
- EMC screening optional

→ Page 30

HeiPac Vario EMV



Universal 19" subrack system for EMC applications

- Varied size range
- Flexible design options
- A wealth of accessories
- EMC screening

→ Page 30

HeiPac Vario ECO



Economical 19" subrack system

- Available in standard sizes
- A wealth of accessories
- EMC screening optional

→ Page 58

HeiPac Vario Compact



Compact subrack system in 21 HP and 42 HP

- For rail or wall mounting
- A wealth of accessories
- EMC screening optional

→ Page 66

HeiPac Vario HEAVY



Sturdy 19" subrack system for mobile use

- Increased mechanical strength
- Certified for use in railway applications as per EN 50155
- A wealth of accessories
- EMC screening optional

→ Page 76

HeiPac EASY



Economical, sturdy 19" subrack system

- Bolts pre-assembled
- A wealth of accessories
- Very easy to assemble

→ Page 82

SUBRACKS

HeiPac Vario / Vario EMC



For standard applications/EMC applications or complex installations

Applications

Subrack system for standard applications or complex installations. Suitable for installation of standardised PCBs or plug-in units up to 400 mm depth.

Technical specifications

- 482.6 mm (19") subrack according to IEC 60 297-3
- 3, 4, 6, 7 and 9 U
- For board depths up to 400 mm
- Side panels of aluminium, clear-chromated
- 10 mm mounting grids for horizontal rails
- Rear equipment for installation of backplanes or connectors
- Separate 19" flanges
- EMC version including EMC gaskets

Benefits at a glance

- Side panels with 10 mm mounting grid
- The HeiPac Vario is upgradeable to EMC
- 19" flanges optionally for front/rear mounting
- Wide range of standard sizes
- For installation of backplanes or connectors
- Broad range of accessories

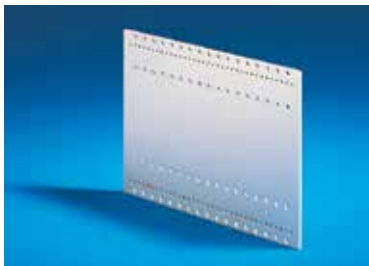

10 mm pitch pattern of holes allows many varieties



Components made of solid aluminium alloy



Contact springs made of stainless steel provide high EMC protection

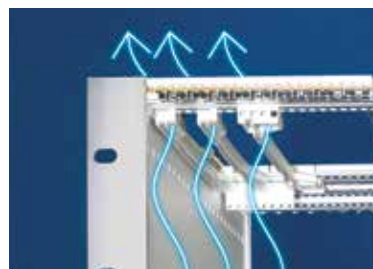

Effective heat dissipation due to open design

EMC diagram for HeiPac Vario/Vario EMC

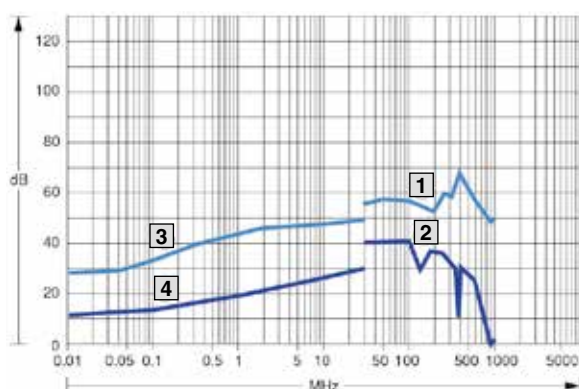

- MHz = Frequency
- dB = HF-attenuation
- 1** E-Field = Electric field (V/m)
EMC subrack
- 2** E-Field standard subrack
- 3** H-Field = Magnetic field (A/m)
EMC subrack
- 4** H-Field standard subrack

HeiPac Vario 3 U, 6 U, 9 U

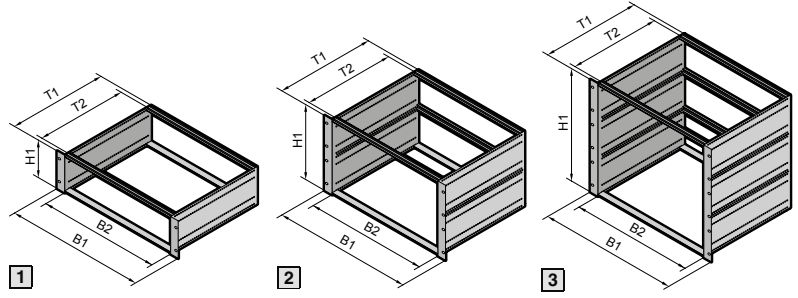

Material/surface finish

Side panels: 2.5 mm aluminium, clear-chromated
 Horizontal rails: Extruded aluminium section, clear-chromated
 19" flanges: Extruded aluminium section, clear-chromated

Supply includes

Flanges, side panels, horizontal rails, threaded inserts, insulating strips or Z rails.

Tests

Shock and vibration tested to:
 IEC 600-68-2-6 test Fc
 IEC 600-68-2-6 test Ea

Standards

HeiPac subracks are based on the system dimensions of IEC 60 297-3

Note

Upgradeable to EMC

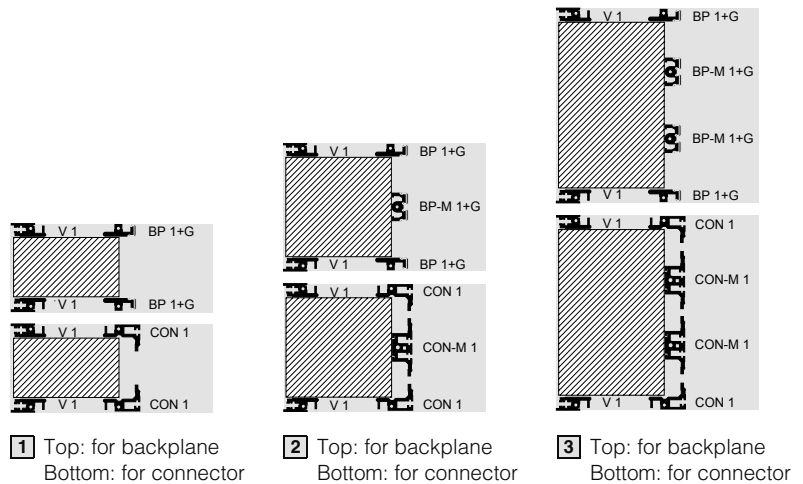

1 Top: for backplane Bottom: for connector
 2 Top: for backplane Bottom: for connector
 3 Top: for backplane Bottom: for connector

					Order No.					
					1		2		3	
U					3		6		9	
Height (H1) mm					132		265.35		398.70	
B1 mm	B2 HP	Side panel (T1) mm	T2 mm	Max. PCB depth mm	For backplane	For connector IEC 60 603-2	For backplane	For connector IEC 60 603-2	For backplane	For connector IEC 60 603-2
482.6 (19")	84	185	160	160	3684.020	3684.034	3684.043	3684.056	-	-
		225	200	160	3684.021	3684.035	3684.044	3684.057	-	-
		245	220	220	3684.022	3684.036	3684.045	3684.058	-	-
		285	260	220	3684.023	3685.281	3684.046	-	-	-
		305	280	280	3685.231	3685.233	3685.238	3685.240	-	-
		345	320	280	3684.024	-	3684.047	-	3684.051	3684.059
		365	340	340	3685.232	3685.234	3685.239	-	-	-
		405	380	340	3684.025	-	3684.048	-	3684.052	3684.060
		465	440	400	3684.026	-	3684.049	-	3684.053	3684.061
		525	500	400	3684.027	-	3684.050	-	3684.054	-
585	560	400	-	-	-	-	3684.055	-		

Other customised subrack solutions are available upon request. Please get in contact with one of our sales representatives for further assistance: Tel. +49 9126 - 29 34 0

SUBRACKS

HeiPac Vario

HeiPac Vario 4 U, 7 U



Material/surface finish

Side panels: 2.5 mm aluminium, clear-chromated
 Horizontal rails: Extruded aluminium section, clear-chromated
 19" flanges: Extruded aluminium section, clear-chromated

Supply includes

Flanges, side panels, horizontal rails, threaded inserts, insulating strips or Z rails.

Tests

Shock and vibration tested to:
 IEC 600-68-2-6 test Fc
 IEC 600-68-2-6 test Ea

Standards

HeiPac subracks are based on the system dimensions of IEC 60 297-3

Note

Upgradeable to EMC

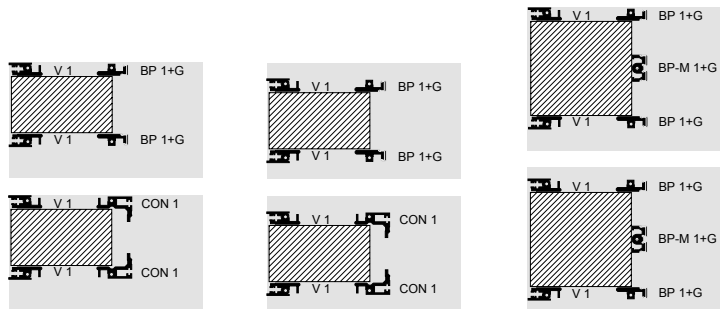
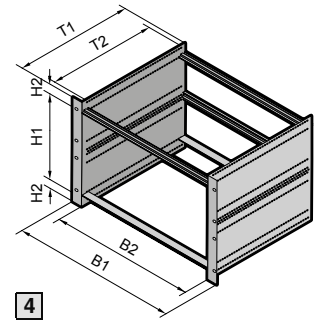
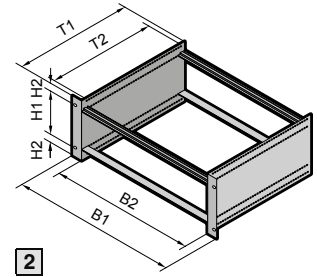
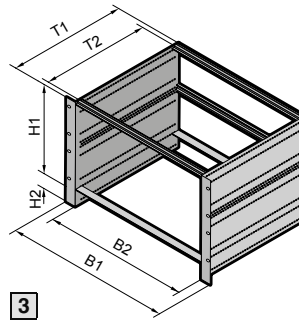
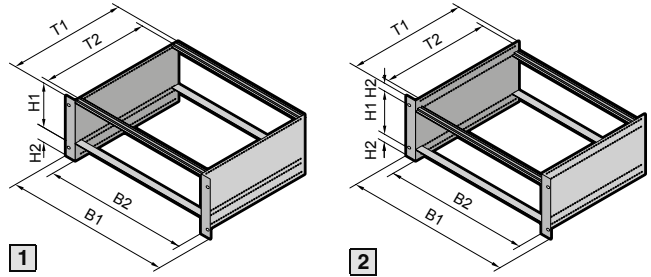

1 Top: for backplane
Bottom: for connector

2 Top: for backplane
Bottom: for connector

3 Top: for backplane
(6 U + 1 U)

4 Bottom: for backplane
(6 U + 2 x 1/2 U)

					Order No.					
					1		2		3	4
U (H1 + H2)		Side panel (T1) mm	T2 mm	Max. PCB depth mm	4 (3 + 1)	4 (3 + 1)	4 (3 + 2 x 1/2)	4 (3 + 2 x 1/2)	7 (6 + 1)	7 (6 + 2 x 1/2)
B1 mm	B2 HP				For backplane	For connector IEC 60 603-2	For backplane	For connector IEC 60 603-2	For backplane	For backplane
482.6 (19")	84	245	220	220	3685.235	-	-	-	-	-
		285	260	220	3684.028	3684.037	3684.031	3684.040	-	-
		305	280	280	3685.236	-	-	-	-	-
		345	320	280	3684.029	3684.038	3684.032	3684.041	-	-
		365	340	340	3685.237	-	-	-	-	-
		405	380	340	3684.030	3684.039	3684.033	3684.042	3684.064	3684.062
		465	440	400	-	-	-	-	3684.065	3684.063

Other customised subrack solutions are available upon request. Please get in contact with one of our sales representatives for further assistance: Tel. +49 9126 - 29 34 0

HeiPac Vario EMC 3 U, 6 U, 9 U

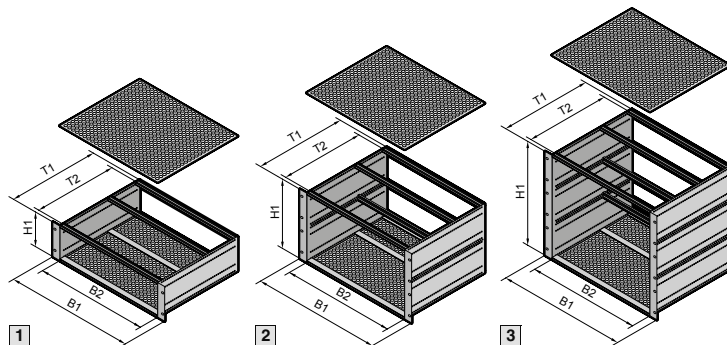

Material/surface finish

Side panels: 2.5 mm aluminium, clear-chromated
 Horizontal rails: Extruded aluminium section, clear-chromated
 19" flanges: Extruded aluminium section, clear-chromated
 Covers: Aluminium, unplated

Supply includes

Flanges, rear trim, side panels, EMC gaskets, covers, mounting blocks, horizontal rails, threaded inserts, insulating strips

Tests

Shock and vibration tested to:
 IEC 600-68-2-6 test Fc
 IEC 600-68-2-27 test Ea

Standards

HeiPac subracks are based on the system dimensions of IEC 60 297-3

EMC



1
 Top: for backplane
 Bottom: for backplane/
 front horizontal rail with
 10 mm extension

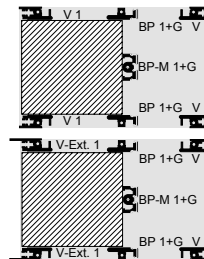

2
 Top: for backplane
 Bottom: for backplane/
 front horizontal rail with
 10 mm extension

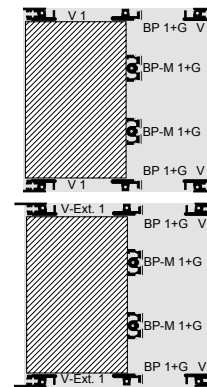

3
 Top: for backplane
 Bottom: for backplane/
 front horizontal rail with
 10 mm extension

					Order No.					
					1		2		3	
U					3		6		9	
Height (H1) mm					132		265.35		398.70	
B1 mm	B2 HP	Side panel (T1) mm	T2 mm	Max. PCB depth mm	For backplane	For backplane ¹⁾	For backplane	For backplane ¹⁾	For backplane	For backplane ¹⁾
482.6 (19")	84	245	220	160	3684.128	3684.142	3684.156	3684.169	-	-
		285	260	220	3684.129	3684.143	3684.157	3684.170	-	-
		305	280	220	3685.241	3685.243	3685.242	3685.244	-	-
		345	320	280	3684.130	3684.144	3684.158	3684.171	3684.162	3684.175
		405	380	340	3684.131	3684.145	3684.159	3684.172	3684.163	3684.176
		465	440	400	3684.132	3684.146	3684.160	3684.173	3684.164	3684.177
		525	500	400	3684.133	3684.147	3684.161	3684.174	3684.165	3684.178
		585	560	400	-	-	-	-	3684.166	3684.179

¹⁾ Front horizontal rails with 10 mm extension for injector/extractor handles

Other customised subrack solutions are available upon request. Please get in contact with one of our sales representatives for further assistance: Tel. +49 9126 - 29 34 0

SUBRACKS

HeiPac Vario EMC

HeiPac Vario EMC 4 U, 7 U



Material/surface finish

Side panels: 2.5 mm aluminium, clear-chromated
 Horizontal rails: Extruded aluminium section, clear-chromated
 19" flanges: Extruded aluminium section, clear-chromated
 Covers: Aluminium, unplated

Supply includes

Flanges, rear trim, side panels, EMC gaskets, covers, mounting blocks, horizontal rails, threaded inserts, insulating strips

Tests

Shock and vibration tested to:
 IEC 600-68-2-6 test Fc
 IEC 600-68-2-27 test Ea

Standards

HeiPac subracks are based on the system dimensions of IEC 60 297-3

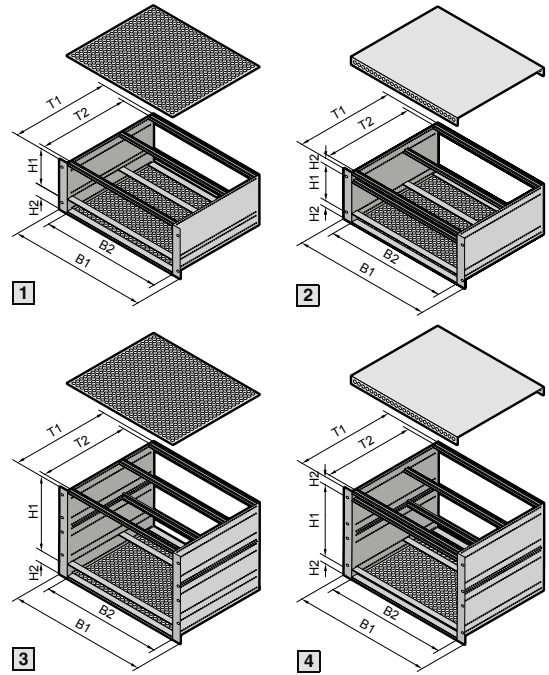

EMC

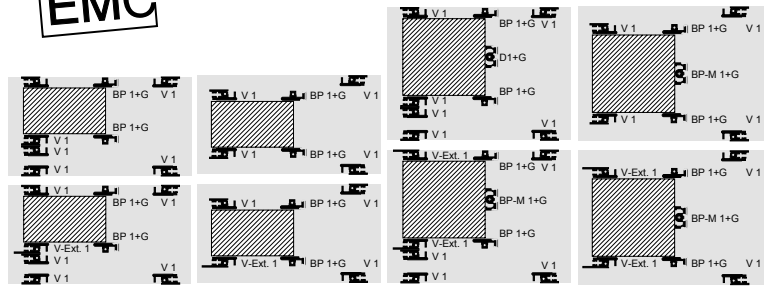

1 Top: for backplane
bottom: for backplane/
front horizontal rail with
10 mm extension

2 Top: for backplane
bottom: for backplane/
front horizontal rail with
10 mm extension

3 Top: for backplane
bottom: for backplane/
front horizontal rail with
10 mm extension

4 Top: for backplane
bottom: for backplane/
front horizontal rail with
10 mm extension

					Order No.							
					1		2		3		4	
U (H1+H2)					4 (3 + 1)	4 (3 + 1)	4 (3 + 2 x 1/2)	4 (3 + 2 x 1/2)	7 (6 + 1)	7 (6 + 1)	7 (6 + 2 x 1/2)	7 (6 + 2 x 1/2)
B1 mm	B2 HP	Side panel (T1) mm	T2 mm	Max. PCB depth mm	For backplane	For backplane ¹⁾	For backplane	For backplane ¹⁾	For backplane	For backplane ¹⁾	For backplane	For backplane ¹⁾
482,6 (19")	84	285	260	220	3684.134	3684.148	3684.137	3684.151	3684.187	3684.192	-	-
		345	320	280	3684.135	3684.149	3684.138	3684.152	3684.188	3684.193	3684.189	3684.196
		405	380	340	3684.136	3684.150	3684.139	3684.153	3684.180	3684.194	3684.190	3684.197
		465	440	400	-	-	-	-	3684.181	3684.195	3684.191	3684.198

¹⁾ Front horizontal rails with 10 mm extension for injector/extractor handles

Other customised subrack solutions are available upon request. Please get in contact with one of our sales representatives for further assistance: Tel. +49 9126 - 29 34 0

Components, accessories and services for HeiPac Vario

In addition to the presented subrack-kits, we offer components and accessories for your individual configuration on the following pages

WE MEET YOUR INDIVIDUAL NEEDS!

You are looking for a product in the field of electronic packaging that is not in our catalogue? Please contact us! Due to our extensive range of services we can meet all your demands.







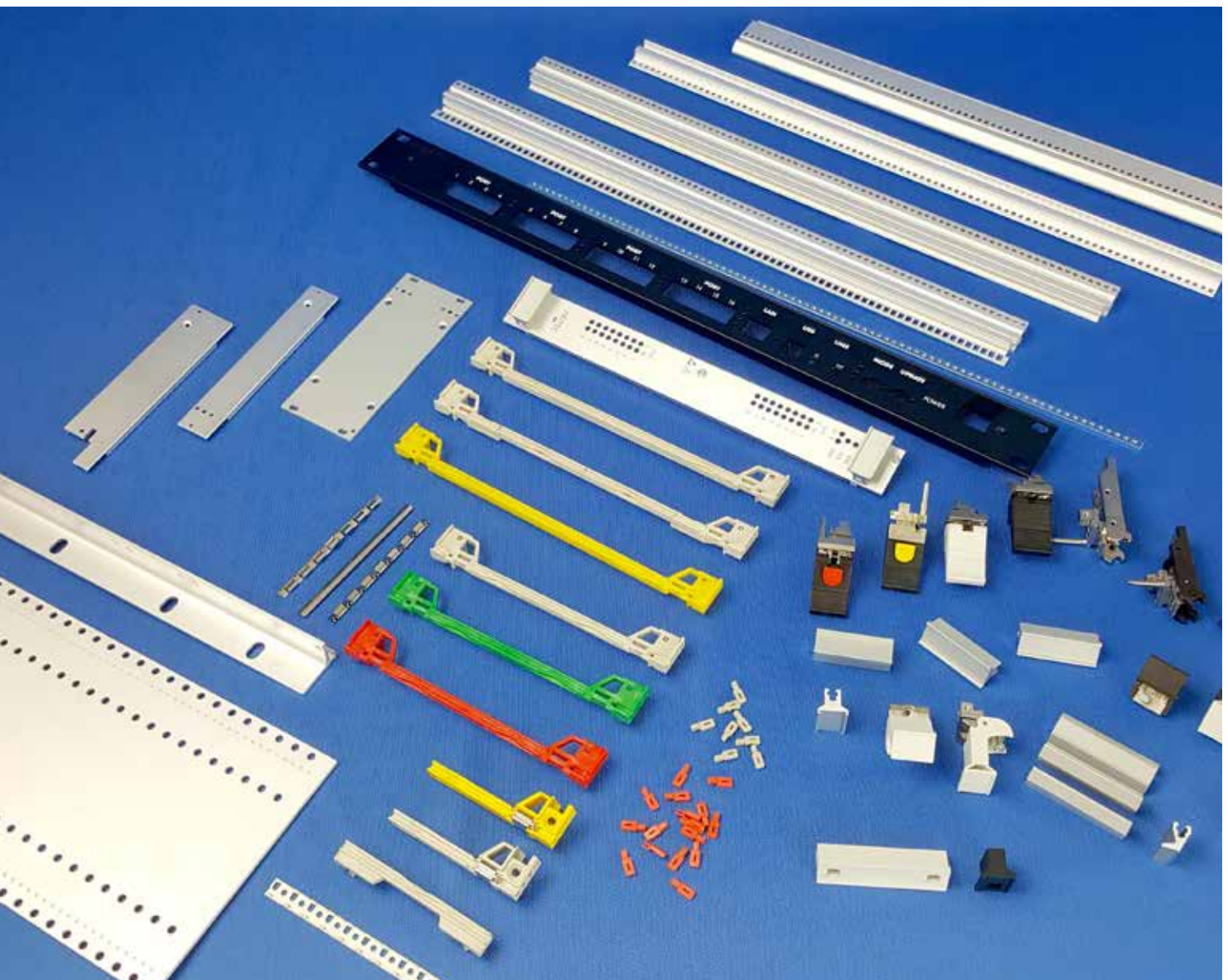

























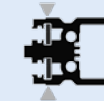

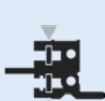

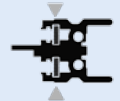



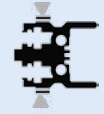

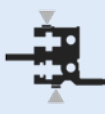
We will gladly submit a tailored quotation.

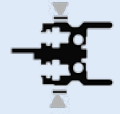
Phone: 09126 - 29 34 0

E-Mail: eps-quote@heitec.de

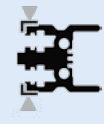

Overview horizontal rails HeiPac Vario

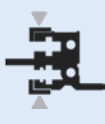
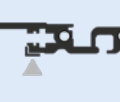
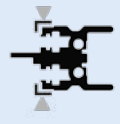





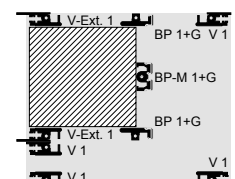
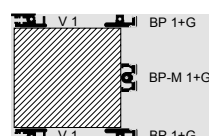
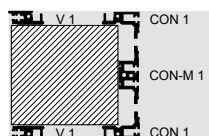























Main sections	V 1 Front horizontal rail	V 2 Front horizontal rail, with double screw fastening	V 3 Double front horizontal rail	V-Ext. 1 Front horizontal rail, with 10 mm extension, for extractor handle type IV or VII	V-Ext. 2 Double front horizontal rail, with 10 mm extension	V-Ext. 3 Front horizontal rail, with 10 mm extension, with double screw fastening	V-Ext. 4 Double front horizontal rail, with 10 mm extension	BP 1 Rear horizontal rail	BP 2 Rear horizontal rail, with double screw fastening
	Page 38	Page 38	Page 39	Page 39	Page 40	Page 40	Page 41	Page 41	Page 42
Additional sections									
E Adaptor rail, rear centre, to accommodate guide rails 	-	-	-	-	-	-	-	-	-
Page 140									
F Z rail for connector 	-	-	-	-	-	-	-		
Page 144									
G Insulating strip ¹⁾ 	-	-	-	-	-	-	-		
Page 145									
H Conductive strip ²⁾ 	-	-	-	-	-	-	-		
Page 145									
I Threaded insert 								-	
Page 144									
J Identification strips 									
Page 144									
K EMC gaskets, horizontal 								-	-
Page 145									

For ¹⁾insulated or ²⁾conductive attachment of backplanes.

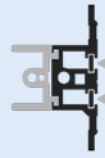
All system requirements may be covered with just a few basic types of horizontal rail. A cost-effective, easy-to-manage range.



Overview horizontal rails HeiPac Vario

Main sections	BP 3 Rear horizontal rail	BP 4 Rear horizontal rail	BP 5 Rear horizontal rail	BP-M 1 Rear horizontal rail, centre	BP-M 2 Rear horizontal rail, centre (also for HeiPac EASY)	CON 1 Rear horizontal rail, with integral Z rail	CON 2 Rear horizontal rail, with integral Z rail	CON-M 1 Rear horizontal rail, with integral Z rail (also for HeiPac EASY)
	Page 42	Page 43	Page 43	Page 44	Page 44	Page 45	Page 45	Page 46
Additional sections								
E Adaptor rail, rear centre, to accommodate guide rails 	-	-	-			-	-	
Page 140								
F Z rail for connector 		-	-		-	-	-	-
Page 144								
G Insulating strip ¹⁾ 		-	-		-	-	-	-
Page 145								
H Conductive strip ²⁾ 		-	-		-	-	-	-
Page 145								
I Threaded insert 		-	-	-	-			
Page 144								
J Identification strips 				-	-		-	-
Page 144								
K EMC gaskets, horizontal 	-	-	-	-	-	-	-	-
Page 145								

For ¹⁾insulated or ²⁾conductive attachment of backplanes.

SUBRACKS

HORIZONTAL RAILS HeiPac Vario / Vario EMC

Horizontal rail Vario V 1, front



To accommodate guide rails and for the attachment of front panels

- Front projection 2.5 mm corresponding to IEC 60 297-3-101
- HP pitch pattern of holes for the precise installation of guide rails
- M4 thread on end face
- Straight-through core hole
- Horizontal rail 192 HP without machining on the end faces. Suitable for cutting to length

Material

Extruded aluminium section

Surface finish

Clear-chromated

Usable width (HP)	Packs of	Order No. unprinted	Order No. printed
4 (left)	1	3684.592	-
4 (right)	1	3684.955	-
8 (left)	1	3684.593	-
8 (right)	1	3684.956	-
12	1	3684.594	-
16	1	3684.595	-
20	1	3684.596	-
21	1	3685.985	-
40	1	3684.960	-
42	1	3684.560	9921.788³⁾
63	1	3684.561	-
84	1	3684.562	9921.789³⁾
84	2	3685.267¹⁾	-
192	1	3688.000²⁾	-

¹⁾ Including 4 assembly screws

²⁾ Anodised

³⁾ with HP pattern printing

+ Also required

Assembly screws M4 x 12
Packs of 100, order no. 3654.300
see page 202

+ Accessories

Threaded inserts, packs of 1, order no. 3684.610
see page 144

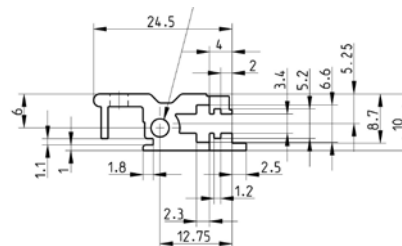
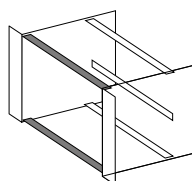

Horizontal rail Vario V 2, front, with double screw fastening



To accommodate guide rails and for the attachment of front panels. The double screw fastening ensures a high level of stability even under extreme loads.

- Front projection 2.5 mm corresponding to IEC 60 297-3-101
- HP pitch pattern of holes for the precise installation of guide rails
- M4 thread on end face
- Straight-through core hole
- Load test to DIN EN/IEC 61 587-1, requirement level SL1
- Shock and vibration tests undertaken as per IEC 61 373 (DIN EN 50 155), Category 1, Class B

Material

Extruded aluminium section

Surface finish

Clear-chromated

Usable width (HP)	Packs of	Order No. unprinted	Order No. printed
84	1	9908.721	9921.793¹⁾

¹⁾ with HP pattern printing

+ Also required

Assembly screws M4 x 12
Packs of 100, order no. 3654.300
see page 202

+ Accessories

Threaded inserts, packs of 1
order no. 3684.610
see page 144

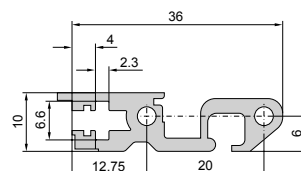
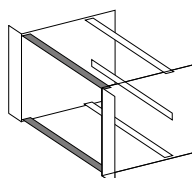

Horizontal rail Vario V 3, front

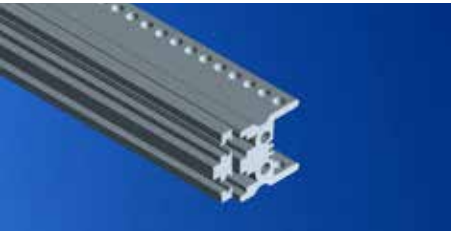

To accommodate guide rails and for the attachment of front panels. For subdivision i. e. 6 U in 2 x 3 U.

- Front projection 2.5 mm corresponding to IEC 60 297-3-101
- HP pitch pattern of holes for the precise installation of guide rails
- M4 thread on end face
- Straight-through core hole

Material

Extruded aluminium section

Surface finish

Clear-chromated

Usable width (HP)	Packs of	Order No. unprinted	Order No. printed
84	1	9904.745	9921.799¹⁾

¹⁾ with HP pattern printing

+ Also required

Assembly screws M4 x 12
Packs of 100, order no. 3654.300
see page 202

+ Accessories

Threaded inserts, packs of 1
order no. 3684.610
see page 144

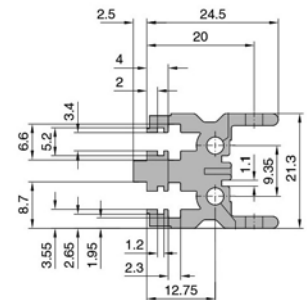
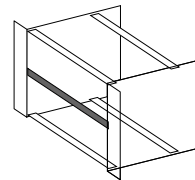

Horizontal rail Vario V-Ext. 1, front, with 10 mm extension



For type IV, IVs and VII injector/extractor handle

To accommodate guide rails and for the attachment of front panels.

- Front projection 10 mm corresponding to IEEE 1101.10 and IEC 60 297-3-102
- HP pitch pattern of holes for the precise installation of guide rails
- M4 thread on end face
- Straight-through core hole

Material

Extruded aluminium section

Surface finish

Clear-chromated

Usable width (HP)	Packs of	Order No. unprinted	Order No. printed
40	1	3684.961	-
42	1	3684.565	9921.790³⁾
63	1	3684.566	-
84	1	3684.567	9921.791³⁾
84	2	3685.269¹⁾	-
192	1	3688.001²⁾	-

¹⁾ Including 4 assembly screws

²⁾ Anodised

³⁾ with HP pattern printing

+ Also required

Assembly screws M4 x 12
Packs of 100, order no. 3654.300
see page 202

+ Accessories

Threaded inserts, packs of 1
order no. 3684.610
see page 144

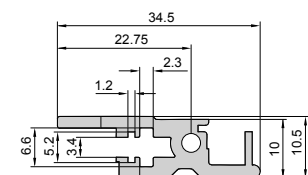
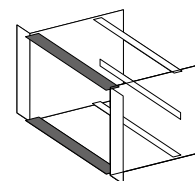

SUBRACKS

HORIZONTAL RAILS HeiPac Vario / Vario EMC

Horizontal rail Vario V-Ext. 2, with 10 mm extension and double screw fastening, front

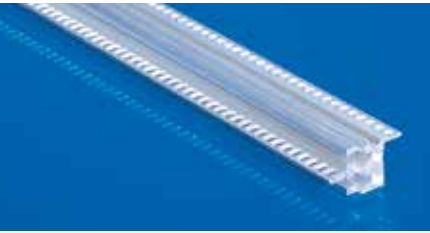

For type IV, IVs and VII injector/extractor handle

To accommodate guide rails and for the attachment of front panels. Double screw fastening and an extra high profile section ensure unique stability evens under extreme loads.

- Front projection 10 mm corresponding to IEEE 1101.10 and IEC 60 297-3-102
- HP pitch pattern of holes for the precise installation of guide rails
- M4 thread on end face
- Straight-through core hole

Material

Extruded aluminium section

Surface finish

Clear-chromated

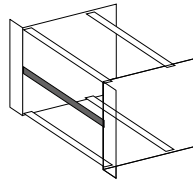

Usable width (HP)	Packs of	Order No.
84	1	3687.724

+ Also required

Assembly screws M4 x 12
Packs of 100, order no. 3654.300
see page 202

+ Accessories

Threaded inserts, packs of 1, order no. 3684.610
see page 144

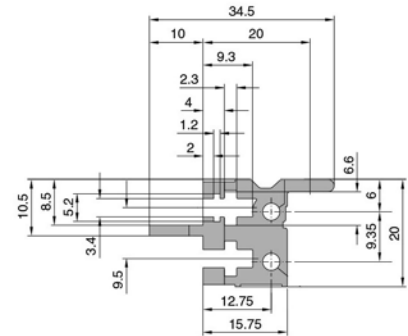

Horizontal rail Vario V-Ext. 3, with 10 mm extension and double screw fastening, front



For type IV, IVs and VII injector/extractor handle

To accommodate guide rails and for the attachment of front panels. The double screw fastening ensures a high level of stability even under extreme loads.

- Front projection 10 mm corresponding to IEEE 1101.10 and IEC 60 297-3-102
- HP pitch pattern of holes for the precise installation of guide rails
- M4 thread on end face
- Straight-through core hole

Material

Extruded aluminium section

Surface finish

Clear-chromated

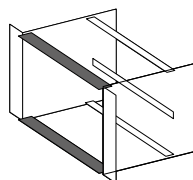

Usable width (HP)	Packs of	Order No. unprinted	Order No. printed
84	1	9908.722	9921.795¹⁾

¹⁾ with HP pattern printing

+ Also required

Assembly screws M4 x 12
Packs of 100, order no. 3654.300
see page 202

+ Accessories

Threaded inserts, packs of 1,
order no. 3684.610
see page 144

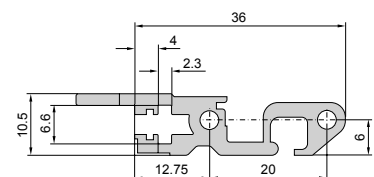

Horizontal rail Vario V-Ext. 4, with 10 mm extension and double screw fastening, front

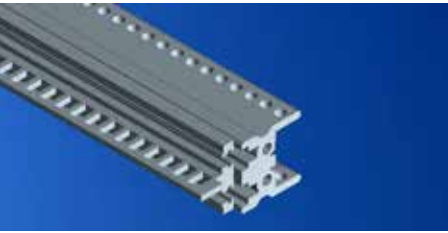

For type IV, IVs and VII injector/extractor handle

For subdivision i. e. 6 U in 2 x 3 U. To accommodate guide rails and for the attachment of front panels

- Front projection 10 mm corresponding to IEEE 1101.10 and IEC 60 297-3-102
- HP pitch pattern of holes for the precise installation of guide rails
- M4 thread on end face
- Straight-through core hole

Material

Extruded aluminium section

Surface finish

Clear-chromated

Usable width (HP)	Packs of	Order No.
84	1	3688.704

+ Also required

Assembly screws M4 x 12
Packs of 100, order no. 3654.300
see page 202

+ Accessories

Threaded inserts, packs of 1,
order no. 3684.610
see page 144

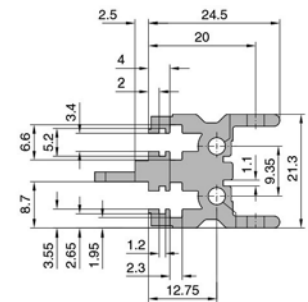
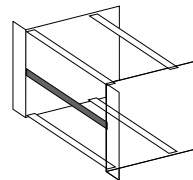

Horizontal rail Vario BP 1, for backplane



To accommodate guide rails and for the attachment of Z rails, insulating strips or conductive strips.

- Tapped holes M2.5 on a 1 HP pitch pattern for mounting backplanes and Z rails
- HP pitch pattern of holes for the precise installation of guide rails
- M4 thread on end face
- Applicable for top-mounting under covers
- Straight-through core hole
- Horizontal rail 192 HP without machining on the end faces. Suitable for cutting to length

Material

Extruded aluminium section

Surface finish

Clear-chromated

Usable width (HP)	Packs of	Order No.
21	1	3685.991
40	1	3684.962
42	1	3684.570
63	1	3684.571
84	1	3684.572
84	2	3685.268¹⁾
192	1	3688.002²⁾

1) Including 4 assembly screws

2) Anodised

+ Also required

Assembly screws M4 x 12
Packs of 100, order no. 3654.300
see page 202

+ Accessories

Conductive strips
see page 145
Insulating strips
see page 145
Z rail
see page 144

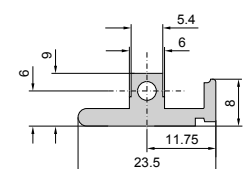
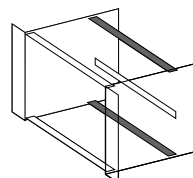

SUBRACKS

HORIZONTAL RAILS HeiPac Vario / Vario EMC

Horizontal rail Vario BP 2, for backplane



To accommodate guide rails and for the attachment of Z rails, insulating strips or conductive strips. The double screw fastening ensures a high level of stability even under extreme loads.

- HP pitch pattern of holes for the precise installation of guide rails
- M4 thread on end face
- For mounting backplanes/Z rails additional threaded inserts (9901.816) are required
- Straight-through core hole

Material

Extruded aluminium section

Surface finish

Clear-chromated

Usable width (HP)	Packs of	Order No.
84	1	9908.723

+ Also required

Assembly screws M4 x 12
Packs of 100, order no. 3654.300
see page 202

+ Accessories

Threaded inserts, packs of 1, order no. 9901.816
see page 144

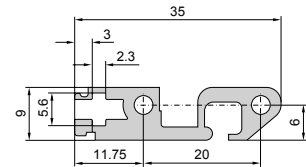
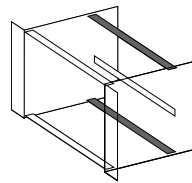

Horizontal rail Vario BP 3, for backplane

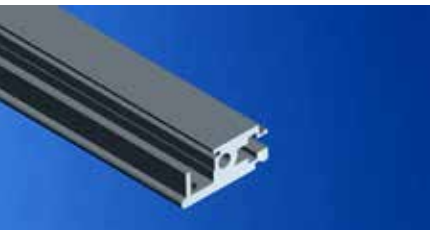

To accommodate guide rails and for the attachment of Z rails, insulating strips or conductive strips.

- HP pitch pattern of holes for the precise installation of guide rails
- Channel for slide-in covers
- Additional threaded inserts (3684.610) are required for mounting backplanes/Z rails
- M4 thread on end face
- Straight-through core hole
- Not suitable for mounting under covers

Material

Extruded aluminium section

Surface finish

Clear-chromated

Usable width (HP)	Packs of	Order No.
84	1	3688.104

+ Also required

Assembly screws M4 x 12
Packs of 100, order no. 3654.300
see page 202

+ Accessories

Threaded inserts, packs of 1, order no. 3684.610
see page 144
Insulating strips
see page 145
Conductive strips
see page 145

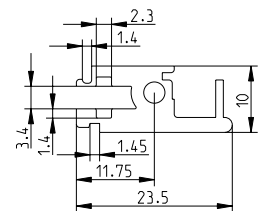
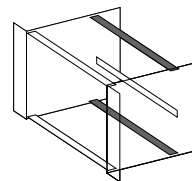

Horizontal rail Vario BP 4, for conductive mounting of backplanes

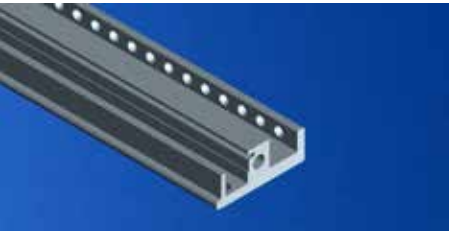

To accommodate guide rails and for the conductive attachment of backplanes

- HP pitch pattern of holes for the precise installation of guide rails
- Tapped holes M2.5 on a HP pitch pattern
- Channel for slide-in covers
- M4 thread on end face
- Straight-through core hole
- Not suitable for mounting under covers
- For mounting slide-in covers
- Due to integrated contact area, insulating strips cannot be used

Material

Extruded aluminium section

Surface finish

Clear-chromated

Usable width (HP)	Packs of	Order No.
84	1	9920.069

+ Also required

Assembly screws M4 x 12
Packs of 100, order no. 3654.300
see page 202

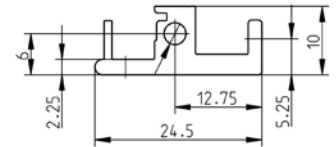
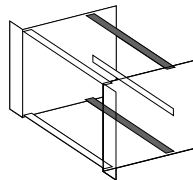

Horizontal rail Vario BP 5, for conductive mounting of backplanes



To accommodate guide rails and for the conductive mounting of backplanes

- Tapped holes M2.5 on a HP pitch pattern
- HP pitch pattern of holes for the precise installation of guide rails
- Due to integrated contact area, insulating strips cannot be used
- Applicable for top-mounting under covers
- M4 thread on end face
- Straight-through core hole

Material

Extruded aluminium section

Surface finish

Clear-chromated

Usable width (HP)	Packs of	Order No.
84	1	9912.522

+ Also required

Assembly screws M4 x 12
Packs of 100, order no. 3654.300
see page 202

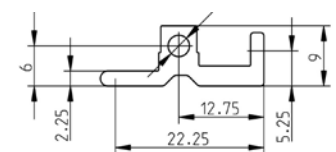
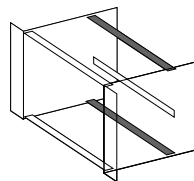

SUBRACKS

HORIZONTAL RAILS HeiPac Vario / Vario EMC

Horizontal rail Vario BP-M 1, for backplane, centre

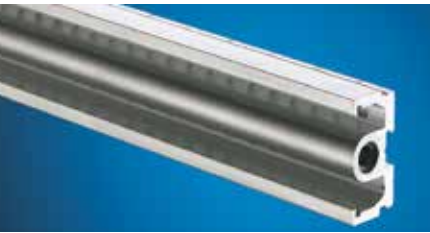

When using 6 U PCBs or box-type plug-in units. Facility for the attachment of Z rails, insulating strips or conductive strips.

- Tapped holes M2.5
- M4 thread on end face
- Straight-through core hole
- Horizontal rail 192 HP for cutting to the required length

Material

Extruded aluminium section

Surface finish

Clear-chromated

Usable width (HP)	Packs of	Order No.
40	1	3684.963
42	1	3684.580
63	1	3684.581
84	1	3684.582
84	1	3685.270 ¹⁾
168	1	3684.579
192	1	3688.003 ²⁾

¹⁾ Including 2 assembly screws

²⁾ Anodised

+ Also required

Assembly screws M4 x 12
Packs of 100, order no. 3654.300

+ Accessories

Insulating strips
see page 145
Conductive strips
see page 145
Z rails
see page 144

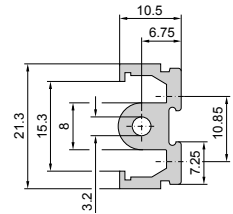
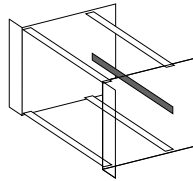

Horizontal rail Vario BP-M 2, for backplane, centre

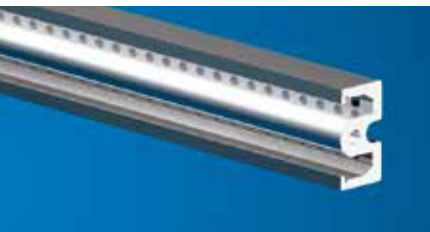

When using 6 U PCBs or box-type plug-in units. Facility for the attachment of Z rails or backplanes.

- Tapped holes M2.5
- M4 thread on end face
- Straight-through core hole
- Due to integrated contact area, insulating strips cannot be used

Material

Extruded aluminium section

Surface finish

Clear-chromated

Usable width (HP)	Packs of	Order No.
84	1	9912.523

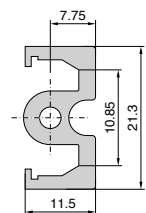
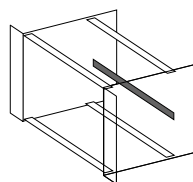

Horizontal rail Vario CON 1, with integral Z rail for connector

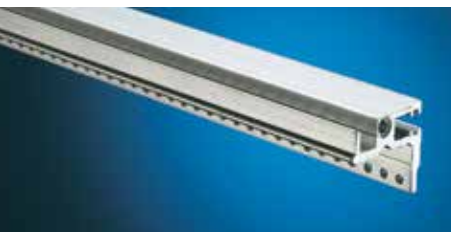

To accommodate guide rails. Integral Z rail for mounting connectors (CON) to IEC 60 603-2.

- HP pitch pattern of holes for the precise installation of guide rails
- Tapped holes M2.5 for connector mounting
- Applicable for top-mounting under covers
- M4 thread on end face
- Straight-through core hole

Material

Extruded aluminium section

Surface finish

Clear-chromated

Usable width (HP)	Packs of	Order No.
42	1	3686.191
63	1	3686.919
84	1	3686.159

+ Also required

Assembly screws M4 x 12
Packs of 100, order no. 3654.300
see page 202

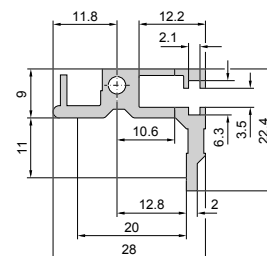
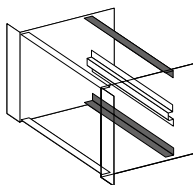

Horizontal rail Vario CON 2, with integral Z rail for connector

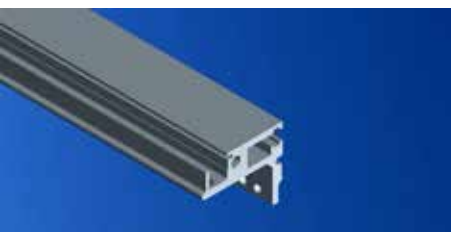

To accommodate guide rails. Integral Z rail for mounting connectors (CON) to DIN 41612

- HP pitch pattern of holes for the precise installation of guide rails
- 84 tapped holes M2.5 for connector mounting
- Not suitable for mounting under covers
- M4 thread on end face
- Straight-through core hole

Material

Extruded aluminium section

Surface finish

Clear-chromated

Usable width (HP)	Packs of	Order No.
84	1	9901.991

+ Also required

Assembly screws M4 x 12
Packs of 100, order no. 3654.300
see page 202

+ Accessories

Threaded inserts, packs of 1, order no. 9901.816
see page 144

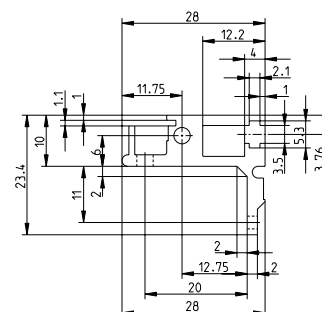
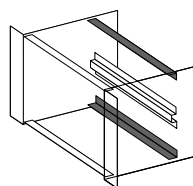

SUBRACKS

HORIZONTAL RAILS HeiPac Vario / Vario EMC

Horizontal rail Vario CON-M 1, with integral Z rail for connector, rear centre



When using 6 U PCBs or box-type plug-in units. Integral Z rail for mounting connectors (CON) to IEC 60 603-2

- Tapped holes M2.5
- M4 thread on end face
- Straight-through core hole

Material

Extruded aluminium section

Surface finish

Clear-chromated

Usable width (HP)	Packs of	Order No.
42	1	3687.600
63	1	3687.601
84	1	3687.602
168	1	3687.603

+ Also required

Assembly screws M4 x 12
Packs of 100, order no. 3654.300
see page 202

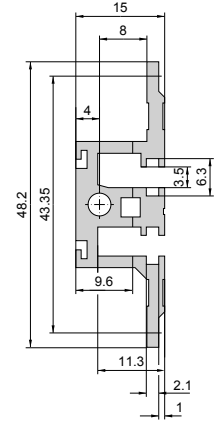
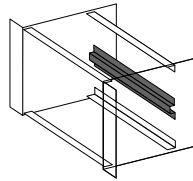

Adaptor rail, rear centre



When subdividing 6 U into 2 x 3 U, the adaptor rail accommodates the guide rails when fastened to the centre horizontal rail.

- HP pitch pattern of holes for the precise installation of guide rails
- M4 and M2.5 thread on the end face
- Applicable in combination with BP-M 1, BP-M 2 and EST-M 1
- Straight-through core hole
- Horizontal rail 192 HP without machining on the end faces. Suitable for cutting to length

Material

Extruded aluminium section

Surface finish

Clear-chromated

Usable width (HP)	Packs of	Order No.
12	1	3684.587
16	1	3684.588
20	1	3684.589
40	1	3684.964
42	1	3684.590
63	1	3686.005
84	1	3684.591
84	1	3685.272¹⁾
168	1	3684.584
192	1	3688.004²⁾

¹⁾ Including 4 assembly screws







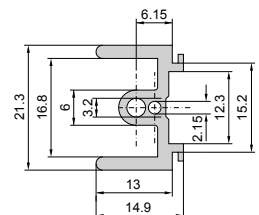
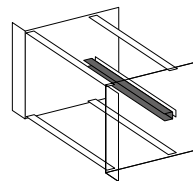







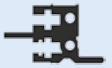

²⁾ Anodised

+ Also required

Assembly screws M4 x 12
Packs of 100, order no. 3654.300
see page 202



Overview HeiPac Vario horizontal rail descriptions

Description old	Description new	Main sections	Description old	Description new	Main sections
A	V 1		C7	BP 3	
A1	V 2		-	BP 4	
-	V 3		-	BP 5	
B	V-Ext. 1		D1	BP-M 1	
B1	V-Ext. 2		D3	BP-M 2	
B2	V-Ext. 3		C3	CON 1	
-	V-Ext. 4		C8	CON 2	
C1	BP 1		D2	CON-M 1	
C6	BP 2				

SUBRACKS COMPONENTS HeiPac Vario / Vario EMC

Side panels for HeiPac Vario



Mounting holes and anti-twist half-shears on a 10 mm pitch pattern.

Material

2.5 mm Aluminium,
Clear-chromated

U			Order No.									
			3	4 (3 + 1)	4 (3 + 2 x ½)	6	7 (6 + 1)	7 (6 + 2 x ½)	9	10	11	
D (T) mm	a ¹⁾ mm	Packs of										
175	150	1	9901.021	-	-	9901.023	-	-	-	-	-	-
185	160	1	3684.511	-	-	3684.529	-	-	-	-	-	-
225	200	1	3684.512	3685.793	3685.890	3684.530	3685.896	3685.893	3685.797	-	-	-
245	220	1	3684.513	3685.850	3685.891	3684.531	3685.897	3685.894	-	-	-	-
285	260	1	3684.514	3684.523	3684.526	3684.532	3685.743	3685.895	-	-	-	-
305	280	1	3684.515	3685.794	-	3684.533	-	-	3685.798	-	-	-
345	320	1	3684.516	3684.524	3684.527	3684.534	3685.744	3685.745	3684.547	-	-	-
365	340	1	3684.517	3685.795	-	3684.535	-	-	3685.799	-	-	-
405	380	1	3684.518	3684.525	3684.528	3684.536	3684.541	3684.543	3684.548	3684.545	-	-
425	400	1	3684.519	-	-	3684.537	-	-	-	-	-	-
465	440	1	3684.520	3685.796	3685.892	3684.538	3684.542	3684.544	3684.549	3684.546	3684.552	-
525	500	1	3684.521	9906.727	-	3684.539	3685.898	3685.959	3684.550	3685.899	3684.553	-
585	560	1	3684.522	9906.914	-	3684.540	-	-	3684.551	-	3684.554	-

¹⁾ a = Distance between the first and last mounting hole.

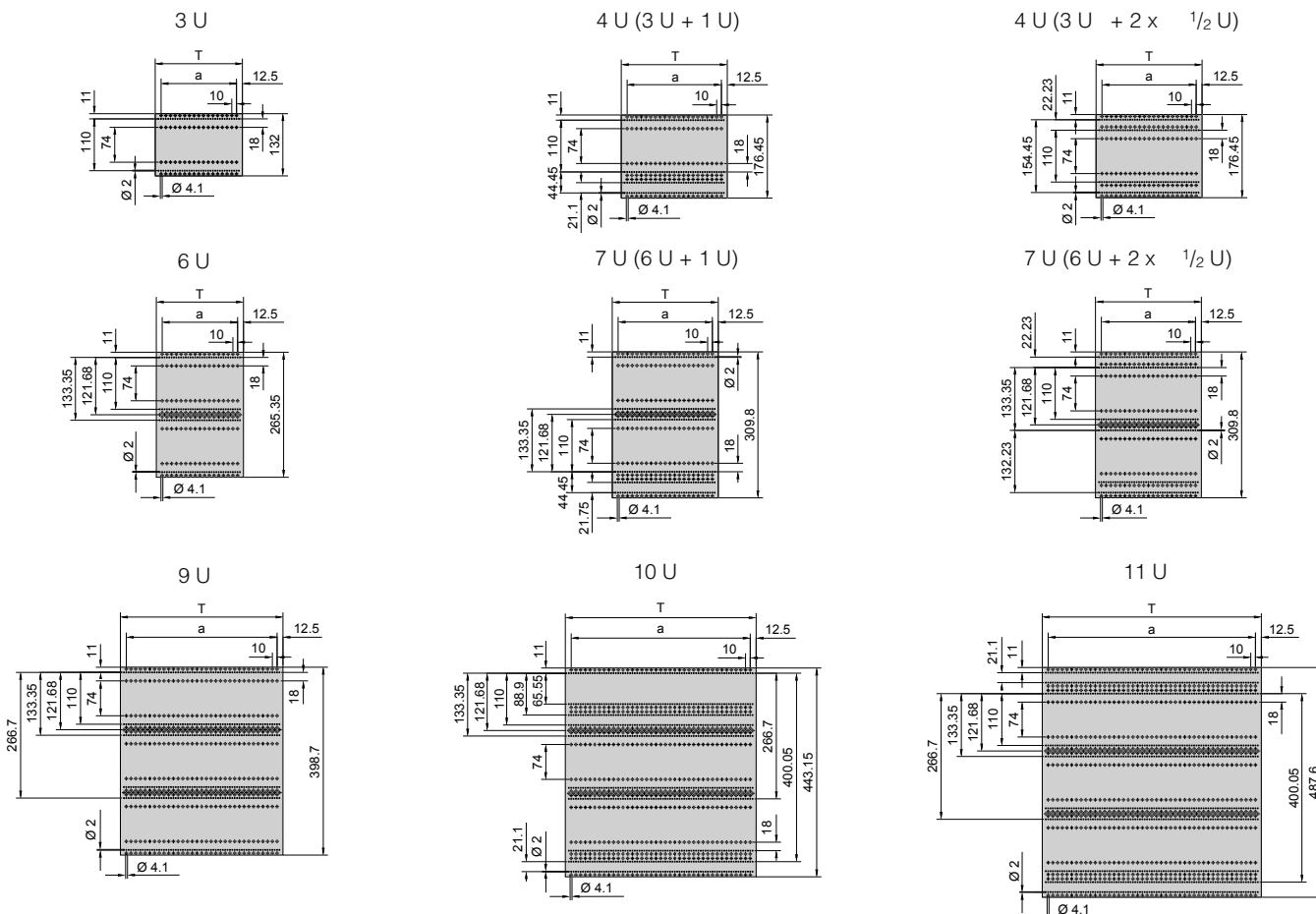

Flanges 19" for HeiPac Vario



With integral channel to accommodate EMC gaskets.

Material
Extruded aluminum section

Surface finish
Clear-chromated

U	Packs of	Order No.	
		with handle holes	without handle holes
2	1	-	3684.614
3	1	3684.622	3684.615
4	1	3684.623	3684.616
6	1	3684.624	3684.617
7	1	3684.625	3684.618
9	1	-	3684.619
10	1	-	3684.620
11	1	-	3684.621

+ Accessories

EMC gaskets, vertical
see page 146
Handles for subrack
see page 57

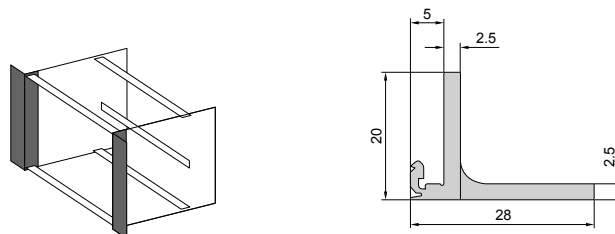

Flanges 19" for HeiPac Vario, set-back



Material
Extruded aluminum section

Surface finish
Clear-chromated

U	Packs of	Order No.
3	1	3684.626
4	1	3684.627
6	1	3684.628
7	1	3684.629
9	1	3684.630
10	1	3684.631
11	1	3684.632

+ Also required

Assembly screws, nuts and washers
packs of 4 sets, Order No. 3687.015
see page 203

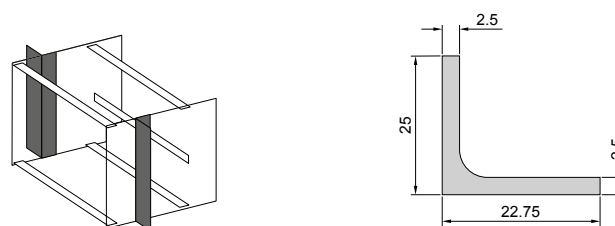

SUBRACKS COVERS HeiPac Vario / Vario EMC

Covers version 1



For all HeiPac Vario subracks

To cover the overall-subrack depth
(EMC application) or as connector protection

- Flat design for top and bottom
- Optionally solid or perforated
- For mounting on the subrack side panel with the aid of mounting blocks

Material

1.0 mm aluminium, unplated, hole diameter 4 mm in perforated version.

Each set includes

2 cover plates
8 mounting blocks 28.5 mm
24 assembly screws

Individual unit includes

1 cover plate

Note

For EMC applications, additional mounting blocks must be fitted across the entire subrack depth.

			Order No.			
			Single piece ¹⁾		Set	
HP	For side panel depth (T) mm	Cover depth (d1) mm	Perforated	Solid	Perforated	Solid
21	225	192	3687.618	3687.620	-	-
21	285	252	3687.619	3687.621	-	-
42	175	142	3684.957	3687.626	-	-
42	225	192	3687.623	3687.627	-	-
42	245	212	3684.958	3687.628	-	-
42	285	252	3685.642	3687.629	-	-
84	175	142	3684.681	3684.680	3685.245	3685.250
84	225	192	3684.694	3684.683	-	-
84	235	202	3685.851	3685.813	-	-
84	245	212	3684.695	3684.684	3685.246	3685.251
84	285	252	3684.696	3684.685	-	-
84	295	262	3685.855	3685.814	-	-
84	305	272	3685.852	3684.686	3685.247	3685.252
84	345	312	3684.698	3684.687	-	-
84	365	332	3685.853	3684.688	3685.248	3685.253
84	405	372	3684.700	3684.689	3685.249	3685.254
84	465	432	3684.701	3684.691	-	-
84	525	492	3684.702	3684.692	-	-
84	585	552	3684.703	3684.693	-	-

+ Also required

¹⁾ Mounting blocks, see page 148

¹⁾ EMC gaskets for cover plates, see page 147

¹⁾ Assembly screws, packs of 100, order no. 3684.233 see page 202

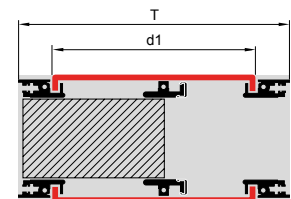
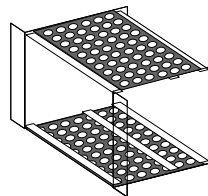

Covers version 2

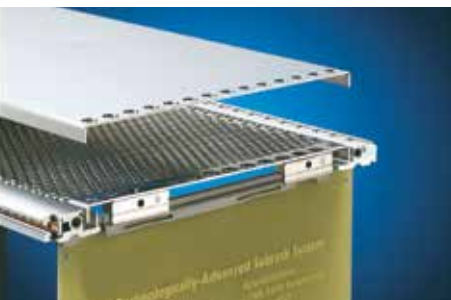

For all HeiPac Vario subracks

To cover the PCB depth

- Flat design for top and bottom
- Optionally solid or perforated
- For mounting on the subrack side panel with the aid of mounting blocks

Material

1.0 mm aluminium, unplated, hole diameter 4 mm in perforated version

Each set includes

2 cover plates
8 mounting blocks 28.5 mm
24 assembly screws

Individual unit includes:

1 cover plates

			Order No.			
			Single piece ¹⁾		Set	
HP	For PCB depth (d2) mm	Cover depth (d1) mm	Perforated	Solid	Perforated	Solid
21	160	142	3687.630	3687.634	-	-
21	220	202	3687.631	3687.635	-	-
42	160	142	3684.957	3687.626	-	-
42	220	202	3687.633	3687.637	-	-
42	280	262	3687.638	3687.639	-	-
84	160	142	3684.681	3684.680	3685.245	3685.250
84	220	202	3685.851	3685.813	-	-
84	280	262	3685.855	3685.814	-	-
84	340	322	3685.856	-	-	-
84	400	382	3685.857	-	-	-

+ Also required

¹⁾ Mounting blocks, see page 148

¹⁾ Assembly screws, packs of 100, order no. 3684.233 see page 202

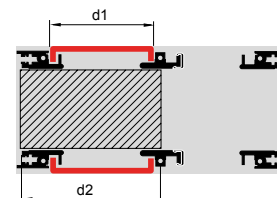
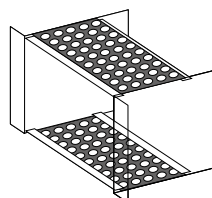

SUBRACKS COVERS HeiPac Vario / Vario EMC

Covers version 3



For all HeiPac Vario subracks

To cover the overall subrack depth (EMC application)

- Cover with 1 U edge fold (item 1), to conceal the 1 U area in the subrack
- A version 1 fl at cover (item 2) is additionally required
- Optionally perforated or solid on the front
- Suitable for subracks 4 U (3 + 1), 7 U (6 + 1)
- For mounting on the subrack side panel with the aid of mounting blocks

Material

1.0 mm aluminium, unplated, hole diameter 4 mm in perforated version.

Note

For EMC applications, mounting blocks must be fitted across the entire subrack depth.

HP	For side panel depth (T) mm	Cover depth (d3) mm	Order No.	
			Perforated	Solid
84	285	270	3684.720	3684.714
84	345	330	3684.721	3684.715
84	405	390	3684.722	3684.716
84	465	450	3684.723	3684.717
84	525	510	3684.724	3684.718
84	585	570	3684.725	3684.719

+ Also required

Mounting blocks, see page 148
EMC gaskets for covers, see page 147
Assembly screws, packs of 100, order no. 3684.233, see page 202
Cover, version 1, see page 161

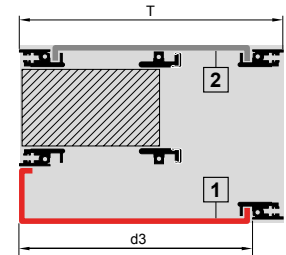
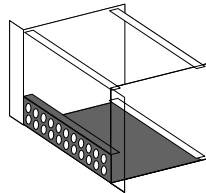

Covers version 4

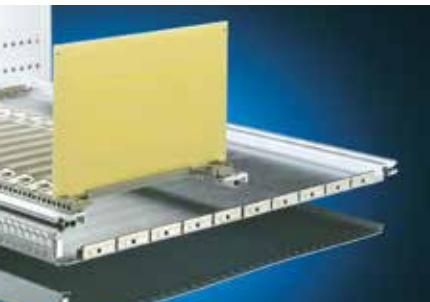

For all HeiPac Vario subracks

To cover the overall subrack depth (EMC application)

- Cover top/bottom with 1/2 U edge fold to cover the 1/2 U section in the subrack
- Optionally perforated or solid on the front
- Suitable for subracks 4 U (3 + 2 x 1/2), 7 U (6 + 2 x 1/2)
- For mounting on the subrack side panel with the aid of mounting blocks.

Material

1.0 mm aluminium, unplated, hole diameter 4 mm in perforated version.

Note

For EMC applications, mounting blocks must be fitted across the entire subrack depth.

HP	For side panel depth (T) mm	Cover depth (d3) mm	Order No.	
			Perforated	Solid
84	285	270	3684.732	3684.726
84	345	330	3684.733	3684.727
84	405	390	3684.734	3684.728
84	465	450	3684.735	3684.729
84	525	510	3684.736	3684.730
84	585	570	3684.737	3684.731

+ Also required

Mounting blocks, see page 148
EMC gaskets for covers, see page 147
Assembly screws, packs of 100, order no. 3684.233, see page 202

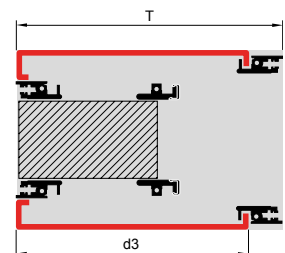
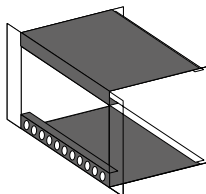

Covers version 5



For all HeiPac Vario subracks

To cover the overall subrack depth or PCB depth.
(EMC application)

Simple assembly:

- Side edge fold with half shears facilitates fast assembly (without mounting blocks) by simply snap-fastening
- Side notches for fitting horizontal rails in 160, 220 or 280 mm depth
- Optionally solid or perforated

Material

1.0 mm aluminium, unplated, hole diameter 4 mm in perforated version.

Supply includes

2 gaskets

HP	Position of side notches for horizontal rails mm	For side panel depth mm	Order No.	
			Perforated	Solid
21	160	175/185	3687.624	-
21	160/220	235	3687.692	-
42	160	175/185	3687.625	-
42	160/220	235	3687.677	-
42	160	245	3687.640	-
84	160	175/185	3687.641	3687.647
84	160	245	3687.642	3687.648
84	160/220	235	3687.643	3687.649
84	160/220	285	3687.644	3687.650
84	160/220	305	3687.645	3687.651
84	160/220/280	345	3687.646	3687.652

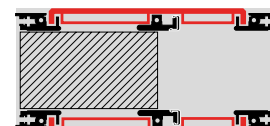
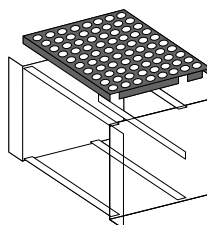

SUBRACKS MOUNTING COVERS HeiPac Vario / Vario EMC

Mounting blocks for cover plates



For mounting covers, versions 1 – 4, on the subrack side panel.

Material

Die-cast zinc

Surface finish

Nickel-plated

Note

For EMC applications, mounting blocks must be fitted across the entire subrack depth. The table here shows the number of mounting blocks required to install 1 cover plate with EMC shielding.

	Packs of	Order No.
Mounting blocks 28.5 mm long	10	3684.234

Number of mounting blocks for max. EMC protection	Cover plate depth mm
4	142
8	192
10	212
12	252
14	272
16	312
18	332
20	372
24	432
28	492
32	552

EMC

+ Also required

Assembly screws M3 x 6, packs of 100, order no. 3684.233, see page 202

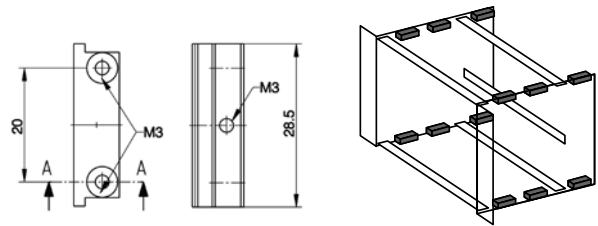

Mounting clips for cover plates

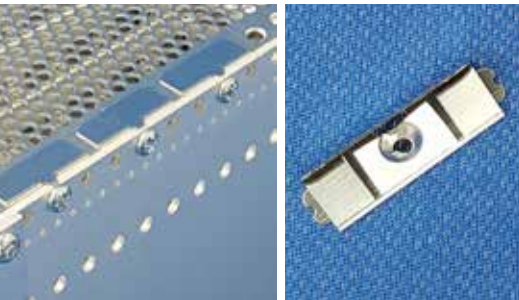

For mounting covers on the subrack side panel

Compatible with cover plate versions 1-4 and the ECO and EASY versions, and with sheet metal blanks 0.8-1.0 mm thick. For EMC applications, mounting clips must be fitted across the full depth of the subrack.

Material

Stainless steel

Length mm	n	Packs of	Order No.
30	1	1	3688.109
90	3	1	9921.722
120	4	1	9921.883
150	5	1	9921.723
180	6	1	9921.884
210	7	1	9921.724
240	8	1	9921.885

+ Also required

Assembly screws, order no. 9921.879

NEW

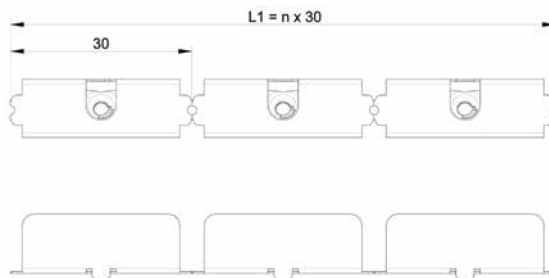

EMC

COMPONENTS FOR EMC INSTALLATION HeiPac Vario / Vario EMC

EMC gaskets, vertical



To ensure EMC protection between the subrack side panel and the front/rear panels. There are two versions available.

Suitable for mounting on:

- 482.6 mm (19") fl anges for subracks
- Corner trims, rear
- EMC contact strip
- U-channel front panels

Material

Stainless steel

German patent
no. 101 15 525 and
no. 198 46 627
US patent no. 6,500,012
US patent no. 7,044,753



EMC

Version 1: Segmented

U	Order No. Packs of 1	Order No. Packs of 10
1	3686.973	3684.236
2	3686.974	3684.237
3	3686.975	3684.238
4	3686.976	3684.239
6	3686.977	3684.240
7	3686.978	3684.241
9	3686.979	3684.242
10	3686.980	3684.243
11	3686.981	3684.244

Version 2: One-piece

U	Order No. Packs of 1	Order No. Packs of 10
2	3688.610	-
3	3688.611	9921.942
4	3688.612	-
5	3688.613	-
6	3688.614	9921.943
7	3688.615	-
8	3688.634	-
9	3688.616	9921.944
10	3688.609	-
11	3688.633	-
12	3688.606	-

EMC contact strip



To ensure EMC protection when horizontal rails are set-back. Integral channel to accommodate EMC gaskets.

Material

Extruded aluminium section

Surface finish

Clear-chromated

Note

2 sections are required for each subrack.

U	Packs of	Order No.
3	1	3684.643
6	1	3684.644
9	1	3684.645

+ Also required

EMC gaskets, vertical, see page 55
Assembly screws M3 x 6, packs of 100,
order no. 3684.233, see page 202

EMC

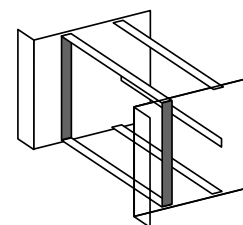

SUBRACKS COMPONENTS FOR EMC INSTALLATION HeiPac Vario / Vario EMC

EMC gaskets for front horizontal rails

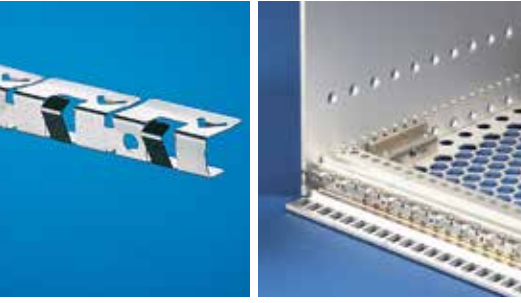

For horizontal EMC protection.
For snapfastening onto the front horizontal rails.

Material

Stainless steel

European patent no. 0 937 375 with validity for DE

US patent no. 6,137,052

Chinese patent no. ZL 97 1 98582.0

Usable width (HP)	Packs of	Order No.
For top/bottom horizontal rail		
40	1	3684.974
40	10	9921.945
84	1	3684.808
84	10	3684.246
For sub-division of 6 U into 2 x 3 U, between 2 horizontal rails		
84	1	3685.789
84	10	3685.229

EMC

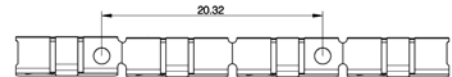

EMC gaskets for covers



For EMC shielding between the horizontal rails and covers.

Material

Stainless steel

HP	Packs of	Order No.
40	1	3684.975
84	1	3684.807
84	10	3684.245

EMC

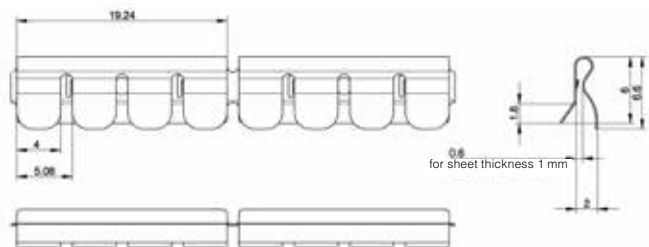

RECOMMENDED ACCESSORIES HeiPac Vario / Vario EMC

Trim section for HeiPac Vario, rear



Ensures 84 HP fit at the rear of the subrack. With integral channel to accommodate EMC gaskets.

- Material**
Extruded aluminium section
- Surface finish**
Clear-chromated

U	Order No.	
	Packs of 1	Packs of 2
2	3684.633	-
3	3684.634	3685.276
4	3684.635	-
6	3684.636	3685.277
7	3684.637	-
9	3684.638	-
10	3684.639	-
11	3684.640	-

+ Accessories

EMC gaskets, vertical, see page 146

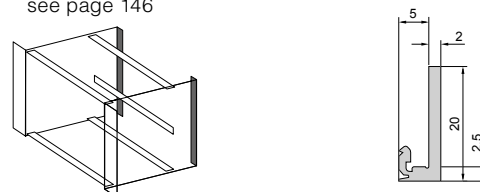

Back cover for HeiPac Vario

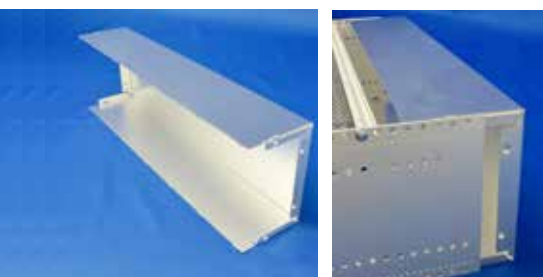

Ensures cover for back of subrack

- Material**
Aluminium
- Surface finish**
Clear-chromated
- Note**

The side panel depth required is obtained by taking the length of the plug-in units used, and adding 85 mm (refer to table). A precondition is the use of a horizontal rail that allows room for additional construction.

NEW

U	Packs of	Order No.
3	1	9921.685
6	1	9921.710

PCB depth mm	Side panel depth mm
160	245
220	305
280	365

Horizontal rail that allows room for additional construction

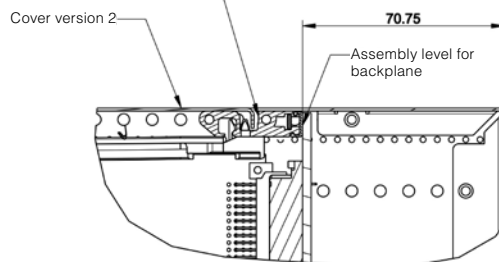

Handles for HeiPac subracks



For fitting on the subrack flange with handle holes and on all component shelves.

- Material**
Die-cast zinc
- Supply includes**
Assembly parts
- Surface finish**
Spray-finished, silver-grey

For	L1	L2	Packs of	Order No.
Subracks 3 U and 4 U	114.5	130.5	2	3636.010
Subracks 6 U and 7 U	248	264	2	3666.010

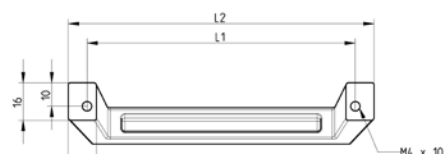

Additional accessories see page

- Guide rails** → 154
- Assembly parts** → 202

SUBRACKS

HeiPac Vario ECO



Economical 19" subrack system for standard applications

Applications

Economical subrack system for standard applications. Suitable for installation of standardised PCBs or plug-in units of 160 and 220 mm depth.

Technical specifications

- Based on the HeiPac Vario subrack family, the basic components (horizontal rails) of the HeiPac Vario ECO are partly compatible with the HeiPac Vario.
- 482.6 mm (19") subrack according to DIN 41 494, part 5/ IEC 60 297-3
- 3 and 6 U
- For board depths: 160 mm and 220 mm
- Side panels of sheet steel, zinc-plated
- Pre-configured assembly points for horizontal rails
- Rear installation for backplanes, optionally for connectors
- Separate 19" flanges

Benefits at a glance

- Fast and easy handling
- Low-cost version
- Upgradable for assembly of backplanes or connectors



Optional EMC upgrade ensures high EMC protection



A wide range of accessories allow manifold expansions



Side panels made of zinc-plated sheet steel

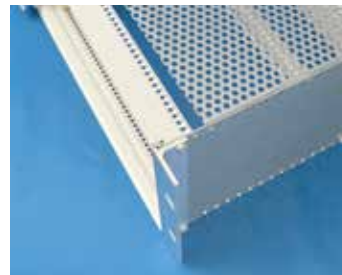

Plug-in top covers facilitate an easy assembly

HeiPac Vario ECO 3 U, 6 U, sheet steel



Material/surface finish

Side panels: 1.5 mm sheet steel, zinc-plated
 Horizontal rails: Extruded aluminium section, clear-chromated
 Flanges: Extruded aluminium section, clear-chromated

Supply includes

Side panels, flanges, horizontal rails, threaded inserts, assembly screws

Tests

Shock and vibration tested to:
 IEC 600-68-2-6 Prüfung Fc
 IEC 600-68-2-27 Prüfung Ea

Standards

HeiPac subracks are based on the system dimensions of IEC 60 297-3.

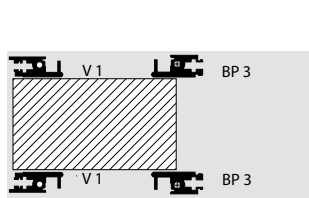
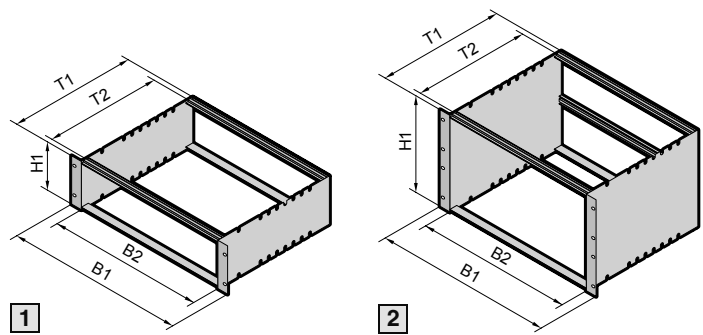

1 for backplane

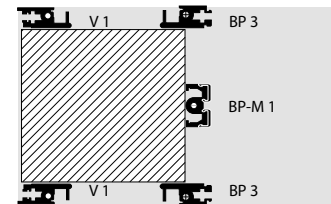

2 for backplane

					Order No.	
					1	2
U (H1)					3	6
B1 mm	B2 HP	Side panel (T1) mm	T2 mm	Max. PCB depth mm	For backplane	For backplane
482.6 (19")	84	175	150	160	3688.114	3688.116
		235	210	220	3688.115	3688.117

Other customised subrack solutions are available upon request. Please get in contact with one of our sales representatives for further assistance: Tel. +49 9126 - 29 34 0

SUBRACKS

HORIZONTAL RAILS HeiPac Vario ECO

Overview horizontal rails HeiPac Vario ECO

Main sections	V 1 Front horizontal rail	BP 3 Rear horizontal rail	CON 2 Rear horizontal rail, with integral Z rail	BP-M 1 Rear horizontal rail, centre
	Page 62	Page 62	Page 61	Page 61
Additional sections				
E Adaptor rail, rear centre, to accommodate guide rails 	-	-	-	
F Z rail for connector 	-		-	
G Insulating strip ¹⁾ 	-		-	
H Conductive strip ²⁾ 	-		-	
I Threaded insert 				-
J Identification strips 			-	-
K EMC gaskets, horizontal 			-	-

For ¹⁾insulated or ²⁾conductive attachment of backplanes.

All system requirements may be covered with just a few basic types of horizontal rail. A cost-effective, easy-to-manage range.

Horizontal rail Vario BP-M 1, for backplane, centre

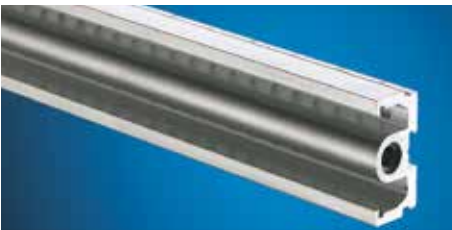

When using 6 U PCBs or box-type plug-in units. Facility for the attachment of Z rails, insulating strips or conductive strips.

- Tapped holes M2.5
- M4 thread on end face
- Straight-through core hole

Material

Extruded aluminium section

Surface finish

Clear-chromated

Usable width (HP)	Packs of	Order No.
84	1	3684.582
84	1	3685.270 ¹⁾

¹⁾ Including 2 assembly screws

+ Also required

Assembly screws M4 x 12
Packs of 100, order no. 3654.300

+ Accessories

Conductive strips
see page 145
Insulating strips
see page 145
Z rails
see page 144

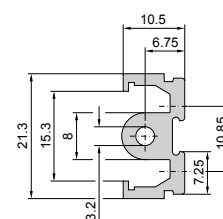
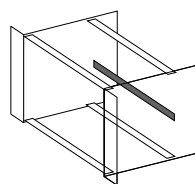

Horizontal rail Vario CON 2, with integral Z rail for connector



To accommodate guide rails. Integral Z rail for mounting connectors (CON) to DIN 41612

- HP pitch pattern of holes for the precise installation of guide rails
- 84 tapped holes M2.5 for connector mounting
- Not suitable for mounting under covers
- M4 thread on end face
- Straight-through core hole

Material

Extruded aluminium section

Surface finish

Clear-chromated

Usable width (HP)	Packs of	Order No.
84	1	9901.991

+ Also required

Assembly screws M4 x 12
Packs of 100, order no. 3654.300

+ Accessories

Threaded inserts, packs of 1, order no. 9901.816
see page 144

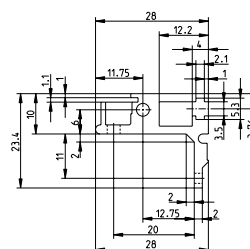
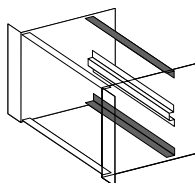

SUBRACKS

HORIZONTAL RAILS HeiPac Vario ECO

Horizontal rail Vario V 1, front



To accommodate guide rails and for the attachment of front panels

- Front projection 2.5 mm corresponding to IEC 60 297-3-101
- HP pitch pattern of holes for the precise installation of guide rails
- M4 thread on end face
- Straight-through core hole

Material

Extruded aluminium section

Surface finish

Clear-chromated

Usable width (HP)	Packs of	Order No.
84	1	3684.562

+ Also required

Assembly screws M4 x 12
Packs of 100, order no. 3654.300
see page 202

+ Accessories

Threaded inserts, packs of 1, order no. 3684.610
see page 144

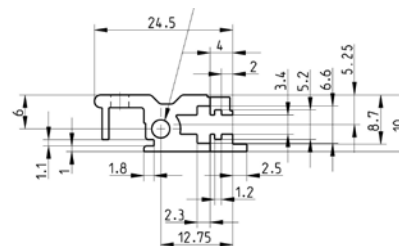
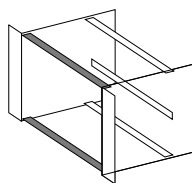

Horizontal rail Vario BP 3, for backplane, with integral channel for slide-in covers

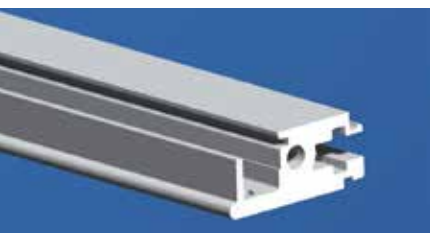

To accommodate guide rails and for the attachment of Z rails, insulating strips or conductive strips.

- HP pitch pattern of holes for the precise installation of guide rails
- Channel for slide-in covers
- Additional threaded inserts (3684.610) are required for mounting backplanes/Z rails
- M4 thread on end face
- Straight-through core hole
- Not suitable for mounting under covers

Material

Extruded aluminium section

Surface finish

Clear-chromated

Usable width (HP)	Packs of	Order No.
84	1	3688.104

+ Also required

Assembly screws M4 x 12
Packs of 100, order no. 3654.300

+ Accessories

Threaded inserts, packs of 1, order no. 3684.610
see page 144

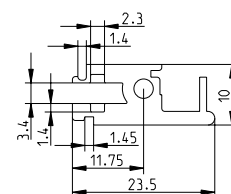
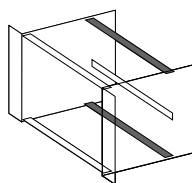

Side panels for HeiPac Vario ECO

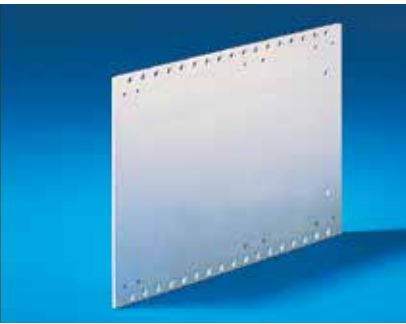

Mounting holes on a 10 mm pitch pattern.

Material

1.5 mm sheet steel
Zinc-plated

D (T) mm	Packs of	Max. board depth mm	Order No.	
			3 U	6 U
175	1	160	3688.100	3688.102
235	1	220	3688.101	3688.103

+ Accessories

Flanges for HeiPac ECO
see page 63

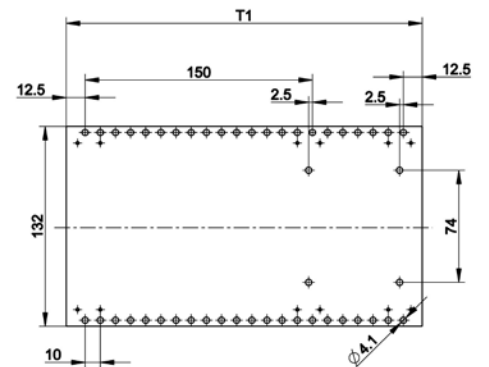
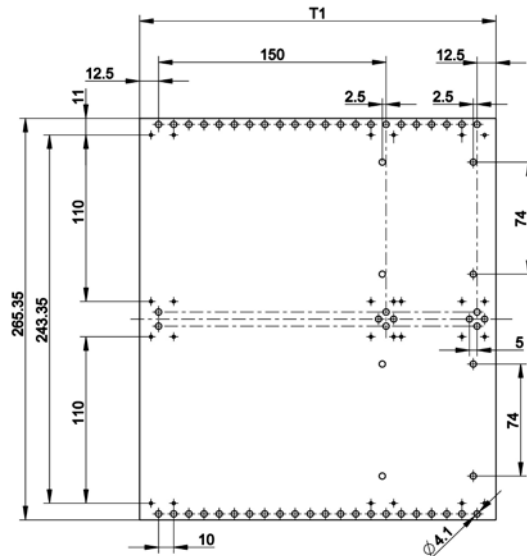

Flanges 19" for HeiPac Vario ECO

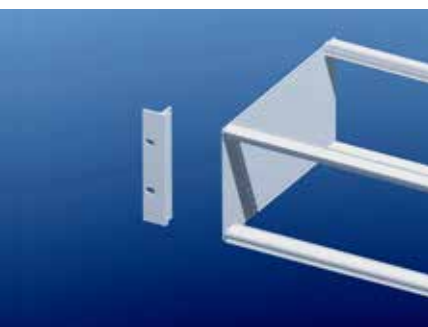

Material

Extruded aluminum section

Surface finish

Clear-chromated

U	Packs of	Order No.
3	1	3688.110
6	1	3688.111

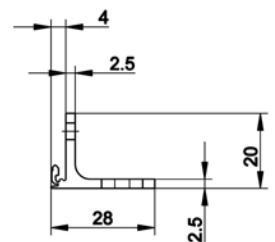

SUBRACKS RECOMMENDED ACCESSORIES HeiPac Vario ECO

Covers for HeiPac Vario ECO

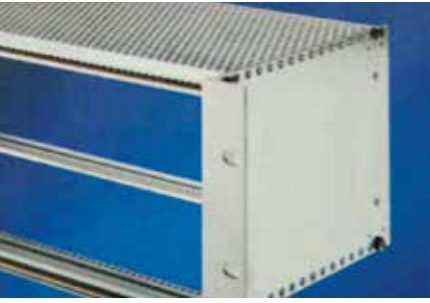

- To cover the overall subrack depth
- Perforated or solid
 - The covers are slid into the horizontal rails
 - Optionally with screwed fastening clips for additional support

Material	Sheet steel
Surface finish	Zinc-plated
Supply includes	1 cover plate



HP	For side panel depth mm	Order No.	
		Perforated	Solid
84	175	3688.105	3688.107
84	235	3688.106	3688.108

+ Accessories
Fastening clips

Packs of	Order No.
1	3688.109

Assembly screw

Packs of	Order No.
100	9921.879

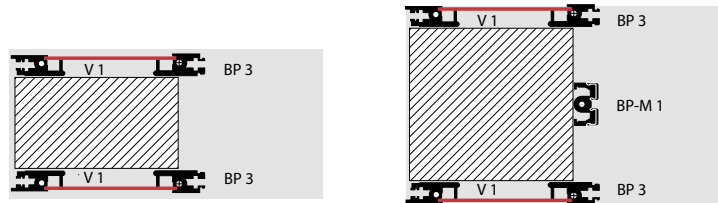

1 for backplane

2 for backplane

Mounting clips for cover plates

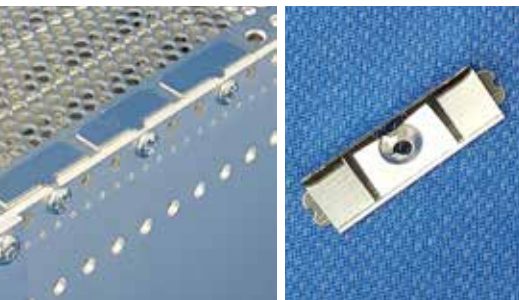

For mounting covers on the sub-rack side panel

Compatible with cover plate versions 1-4 and the ECO and EASY versions, and with sheet metal blanks 0.8-1.0 mm thick. For EMC applications, mounting clips must be fitted across the full depth of the subrack.

Material	Stainless steel
-----------------	-----------------

Length mm	n	Packs of	Order No.
30	1	1	3688.109
90	3	1	9921.722
120	4	1	9921.883
150	5	1	9921.723
180	6	1	9921.884
210	7	1	9921.724
240	8	1	9921.885

+ Also required
Assembly screws, order no. 9921.879

NEW

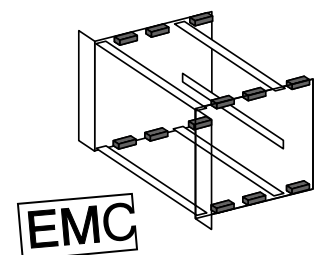
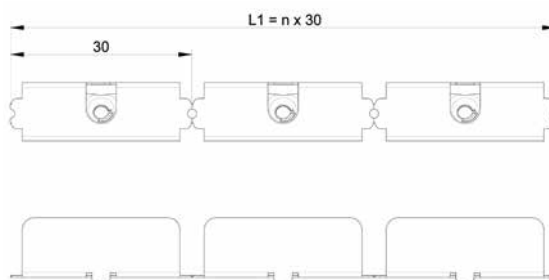

Back cover for HeiPac Vario

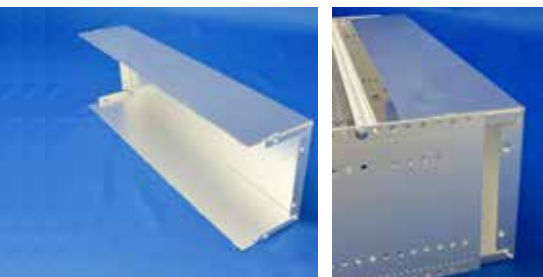

Ensures cover for back of subrack

Material
Aluminium

Surface finish
Clear-chromated

Note
The side panel depth required is obtained by taking the length of the plug-in units used, and adding 85 mm (refer to table).
A precondition is the use of a horizontal rail that allows room for additional construction.

NEW

U	Packs of	Order No.
3	1	9921.685
6	1	9921.710

PCB depth mm	Side panel depth mm
160	245
220	305
280	365

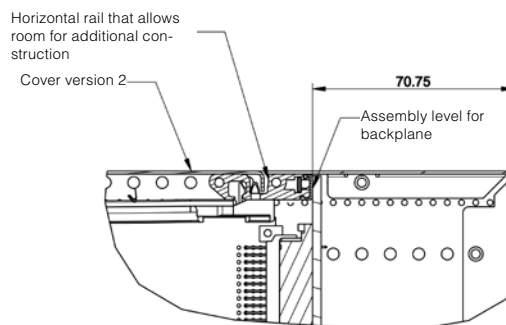

Trim section for HeiPac Vario ECO, rear

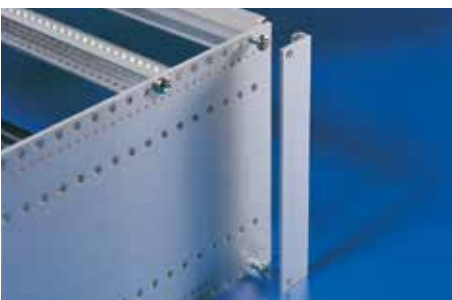

Ensures 84 HP fit at the rear of the subrack. With integral channel to accommodate EMC gaskets.

Material
Extruded aluminium section

Surface finish
Clear-chromated

U	Packs of	Order No.
3	1	3688.112
6	1	3688.113

+ Accessories

EMC gaskets, vertical, see page 146

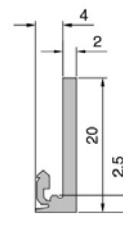
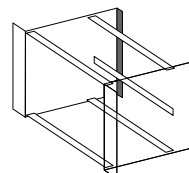

Additional accessories see page

- Guide rails** → 154
- Assembly parts** → 202

SUBRACKS

HeiPac Vario COMPACT



For mounting plates or top-hat rails

Applications

Subrack system for direct mounting in a cabinet. Mounting either on top hat rails or on mounting plate. Suitable for installation of standardised PCBs or plug-in units.

Technical specifications

- Based on the HeiPac Vario subrack family, the basic components of the HeiPac Vario COMPACT are compatible with the HeiPac Vario.
- Subrack according to IEC 60 297-3
- 3 and 6 U
- Side panels of aluminium, clear-chromated
- For board depths up to 160 mm
- Rear equipment for installation of backplanes
- Installation width: 21 and 42 HP

Benefits at a glance

- Direct mounting on a mounting plate or a top-hat rail
- Variable cable entry from bottom/top for EMC version
- Side panels with 10 mm mounting grids for variable system assembly
- Suitable for mounting backplanes
- Optionally in EMC version



Compact dimensions in 21 HP and 42 HP



Adapter for rail mounting



Contact springs provide high EMC protection



Flange for wall-mounting

HeiPac Vario Compact 3 U, 6 U



Material/surface finish

Side panels: 2.5 mm aluminium, clear-chromated
 Horizontal rails: Extruded aluminium section, clear-chromated
 Flanges: Extruded aluminium section, clear-chromated

Supply includes

Side panels, rear trims, flanges for mounting plates or top-hat rail adaptors, EMC front/rear panels, horizontal rails, threaded inserts, insulating strips

EMC version additional includes:
 EMC gaskets, covers

Tests

Shock and vibration tested to:
 IEC 600-68-2-6 test Fc
 IEC 600-68-2-27 test Ea

Standards

HeiPac subracks are based on the system dimensions of IEC 60 297-3.

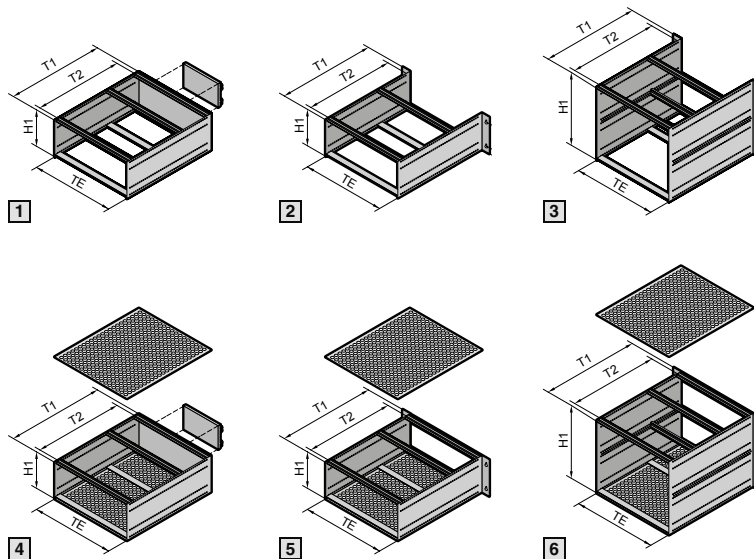

B = Width HE = U
 T = Depth TE = HP

1 4
 HeiPac Compact 3 U for top-hat rail

2 3 5 6
 HeiPac Compact 3 U for mounting plate

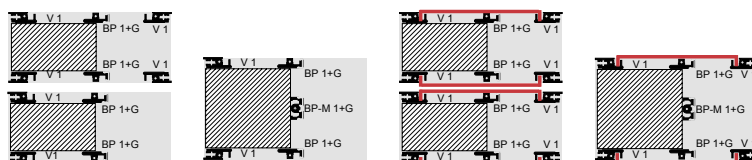

1 Top: for top-hat rail

2 Bottom: for mounting plate

3 For mounting plate

4 Top: EMC for top-hat rail

5 Bottom: EMC for mounting plate

6 EMC for mounting plate

			Order No.					Order No. EMC				
			1	2	1	2	3	4	5	4	5	6
U			3	3	3	3	6	3	3	3	3	6
Height (H1) mm			132	132	132	132	265.35	132	132	132	132	265.35
HP			21	21	42	42	42	21	21	42	42	42
Attachment			Top-hat rail	Mounting plate	Top-hat rail	Mounting plate	Mounting plate	Top-hat rail	Mounting plate	Top-hat rail	Mounting plate	Mounting plate
Side panel (T1) mm	T2 mm	Max. PCB depth mm	For backplane									
225	200	160	3687.667	3687.669	3687.671	3687.673	3687.680	3687.682	3687.684	3687.686	3687.688	3687.690
285	260	220	3687.668	3687.670	3687.672	3687.674	3687.681	3687.683	3687.685	3687.687	3687.689	3687.691

Other customised subrack solutions are available upon request. Please get in contact with one of our sales representatives for further assistance: Tel. +49 9126 - 29 34 0

SUBRACKS

HeiPac Vario COMPACT

Components, accessories and services for HeiPac Vario COMPACT

In addition to the presented subrack-kits, we offer components and accessories for your individual configuration on the following pages.

WE MEET YOUR INDIVIDUAL NEEDS!

You are looking for a product in the field of electronic packaging that is not in our catalogue? Please contact us! Due to our extensive range of services we can meet all your demands.







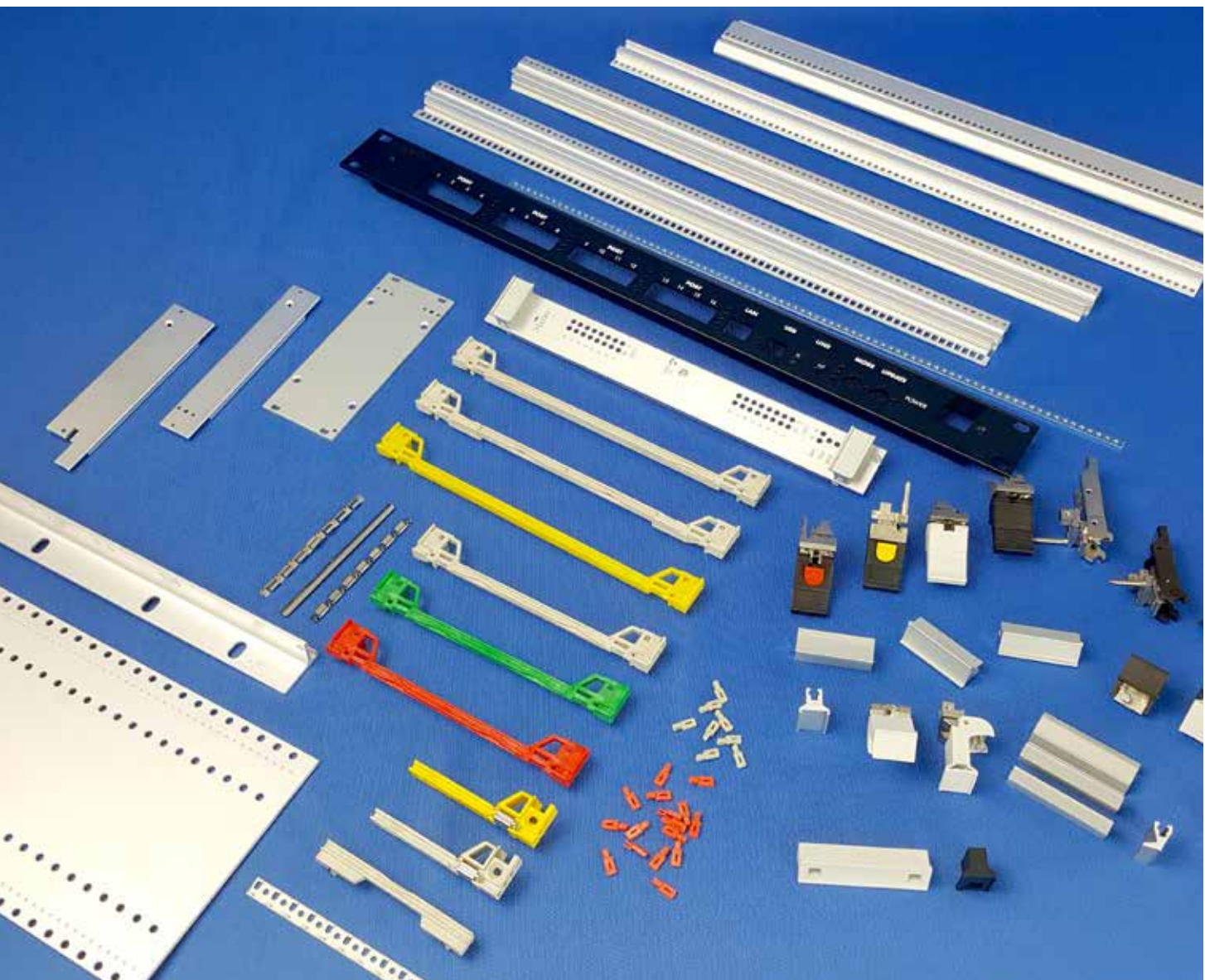





















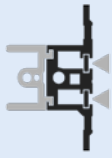

We will gladly submit a tailored quotation.

Phone: 09126 - 29 34 0

E-Mail: eps-quote@heitec.de



Overview horizontal rails HeiPac Vario COMPACT

Main sections	V 1 Front horizontal rail	V-Ext. 1 Front horizontal rail, with 10 mm extension, for extractor handle type IV or VII	BP 1 Rear horizontal rail	CON 1 Rear horizontal rail, with integral Z rail	BP-M 1 Rear horizontal rail, centre	CON-M 1 Rear horizontal rail, with integral Z rail (also for HeiPac EASY)
Additional sections	Page 70 	Page 70 	Page 71 	Page 71 	Page 72 	Page 72 
E Adaptor rail, rear centre, to accommodate guide rails  Page 140	-	-	-	-		
F Z rail for connector  Page 144	-	-		-		-
G Insulating strip ¹⁾  Page 145	-	-		-		-
H Conductive strip ²⁾  Page 145	-	-		-		-
I Threaded insert  Page 144			-		-	
J Identification strips  Page 144					-	-
K EMC gaskets, horizontal  Page 145			-	-	-	-

For ¹⁾insulated or ²⁾conductive attachment of backplanes.

All system requirements may be covered with just a few basic types of horizontal rail. A cost-effective, easy-to-manage range.

SUBRACKS HORIZONTAL RAILS HeiPac Vario COMPACT

Horizontal rail Vario V 1, front



To accommodate guide rails and for the attachment of front panels

- Front projection 2.5 mm corresponding to IEC 60 297-3-101
- HP pitch pattern of holes for the precise installation of guide rails
- M4 thread on end face
- Straight-through core hole

Material

Extruded aluminium section

Surface finish

Clear-chromated

Usable width (HP)	Packs of	Order No.
21	1	3685.985
42	1	3684.560

+ Also required

Assembly screws M4 x 12
Packs of 100, order no. 3654.300

+ Accessories

Threaded inserts, packs of 1, order no. 3684.610
see page 144

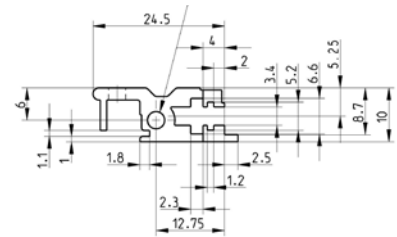
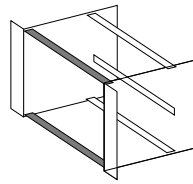

Horizontal rail Vario V-Ext. 1, front, with 10 mm extension



For type IV, IVs and VII injector/extractor handle

To accommodate guide rails and for the attachment of front panels.

- Front projection 10 mm corresponding to IEEE 1101.10 and IEC 60 297-3-102
- HP pitch pattern of holes for the precise installation of guide rails
- M4 thread on end face
- Straight-through core hole

Material

Extruded aluminium section

Surface finish

Clear-chromated

Usable width (HP)	Packs of	Order No. unprinted	Order No. printed
42	1	3684.565	9921.790¹⁾

¹⁾ with HP pattern printing

+ Also required

Assembly screws M4 x 12
Packs of 100, order no. 3654.300
see page 202

+ Accessories

Threaded inserts, packs of 1
order no. 3684.610
see page 144

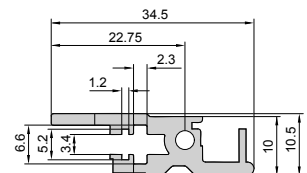
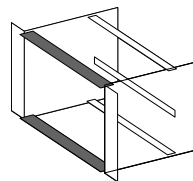

Horizontal rail Vario BP 1, for backplane



To accommodate guide rails and for the attachment of Z rails, insulating strips or conductive strips.

- Tapped holes M2.5 on a 1 HP pitch pattern for mounting backplanes and Z rails
- HP pitch pattern of holes for the precise installation of guide rails
- M4 thread on end face
- Applicable for top-mounting under covers
- Straight-through core hole

Material

Extruded aluminium section

Surface finish

Clear-chromated

Usable width (HP)	Packs of	Order No.
21	1	3685.991
42	1	3684.570

+ Also required

Assembly screws M4 x 12
Packs of 100, order no. 3654.300
see page 202

+ Accessories

Conductive strips
see page 145
Insulating strips
see page 145
Z rail
see page 144

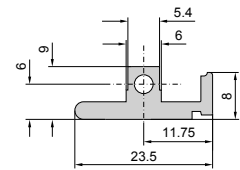
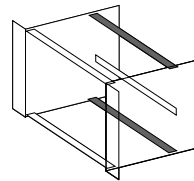

Horizontal rail Vario CON 1, with integral Z rail for connector

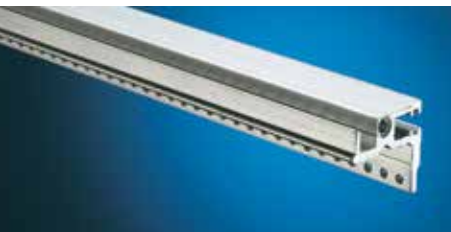

To accommodate guide rails. Integral Z rail for mounting connectors (CON) to IEC 60 603-2.

- HP pitch pattern of holes for the precise installation of guide rails
- Tapped holes M2.5 for connector mounting
- Applicable for top-mounting under covers
- M4 thread on end face
- Straight-through core hole

Material

Extruded aluminium section

Surface finish

Clear-chromated

Usable width (HP)	Packs of	Order No.
42	1	3686.191

+ Also required

Assembly screws M4 x 12
Packs of 100, order no. 3654.300
see page 202

+ Accessories

Threaded inserts, packs of 1
Order no. 3684.608
see page 144

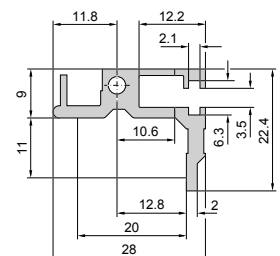
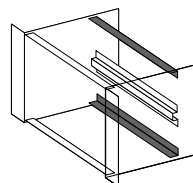

SUBRACKS

HORIZONTAL RAILS HeiPac Vario COMPACT

Horizontal rail Vario BP-M 1, for backplane, centre

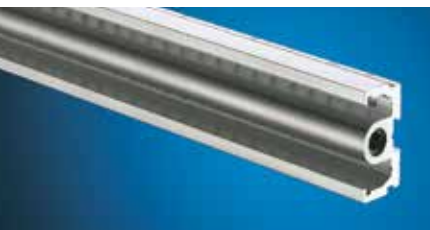

When using 6 U PCBs or box-type plug-in units. Facility for the attachment of Z rails, insulating strips or conductive strips.

- Tapped holes M2.5
- M4 thread on end face
- Straight-through core hole

Material

Extruded aluminium section

Surface finish

Clear-chromated

Usable width (HP)	Packs of	Order No.
42	1	3684.580

+ Also required

Assembly screws M4 x 12
Packs of 100, order no. 3654.300
see page 202

+ Accessories

Conductive strips
see page 145
Insulating strips
see page 145
Z rails
see page 144

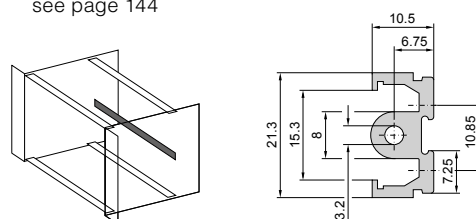

Horizontal rail Vario CON-M 1, with integral Z rail for connector, rear centre



When using 6 U PCBs or box-type plug-in units. Integral Z rail for mounting connectors (CON) to IEC 60 603-2

- Tapped holes M2.5
- M4 thread on end face
- Straight-through core hole

Material

Extruded aluminium section

Surface finish

Clear-chromated

Usable width (HP)	Packs of	Order No.
42	1	3687.600

+ Also required

Assembly screws M4 x 12
Packs of 100, order no. 3654.300
see page 202

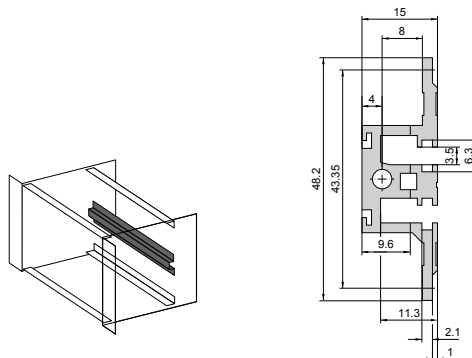

Adaptor rail, rear centre

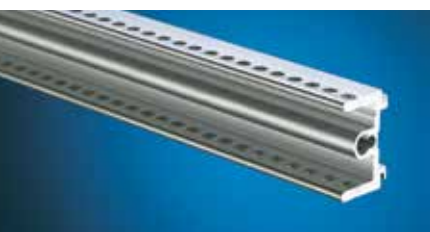

When subdividing 6 U into 2 x 3 U, the adaptor rail accommodates the guide rails when fastened to the centre horizontal rail.

- HP pitch pattern of holes for the precise installation of guide rails
- M4 and M2.5 thread on the end face
- Applicable in combination with BP-M 1, BP-M 2 and EST-M 1
- Straight-through core hole

Material

Extruded aluminium section

Surface finish

Clear-chromated

Usable width (HP)	Packs of	Order No.
42	1	3684.590

+ Also required

Assembly screws M4 x 12
Packs of 100, order no. 3654.300
see page 202

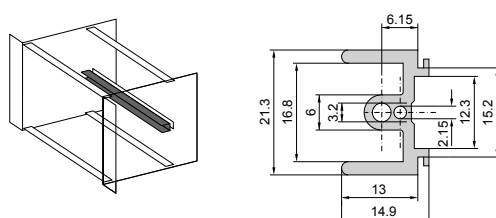

Side panels for HeiPac Vario

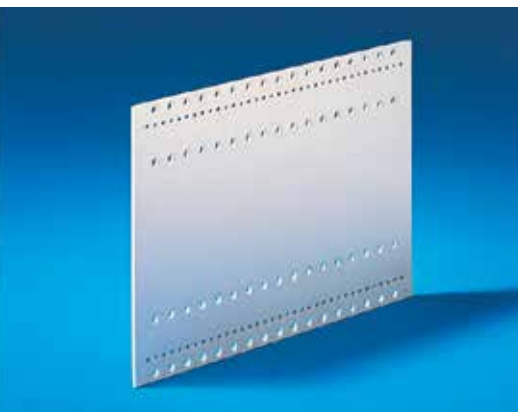

Mounting holes and anti-twist half-shears on a 10 mm pitch pattern.

Material

2.5 mm Aluminium,
Clear-chromated

			Order No.	
U			3	6
T mm	a ¹⁾ mm	Packs of		
225	200	1	3684.512	3684.530
285	260	1	3684.514	3684.532
Versions with PG gland:				
225	200	1	3687.746	3687.758
285	260	1	3687.747	3687.749

¹⁾ a = Distance between the first and last mounting hole.

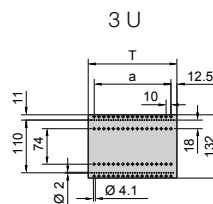
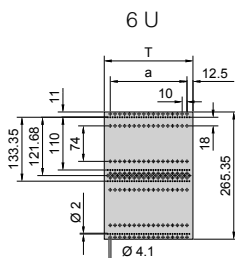

Mounting blocks for cover plates



For mounting covers, versions 1 – 4, on the subrack side panel.

Material

Die-cast zinc

Surface finish

Nickel-plated

Note

For EMC applications, mounting blocks must be fitted across the entire subrack depth. The table here shows the number of mounting blocks required to install 1 cover plate with EMC shielding.

	Packs of	Order No.
Mounting blocks 28.5 mm long	10	3684.234

Number of mounting blocks for max. EMC protection	Cover plate depth mm
4	142
8	192
10	212
12	252
14	272
16	312
18	332
20	372
24	432
28	492
32	552

EMC

+ Also required

Assembly screws M3 x 6, packs of 100, order no. 3684.233, see page 202

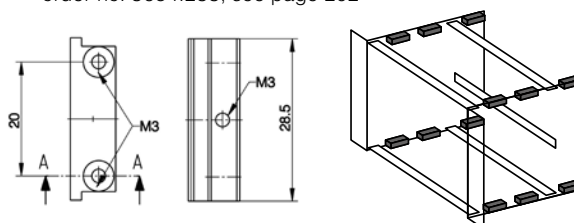

Flange 19" for HeiPac Vario COMPACT, for applications with mounting plate

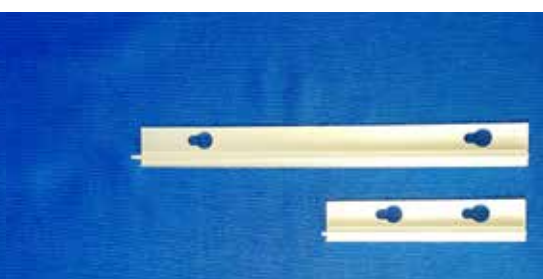

Material

Extruded aluminium section

Surface finish

Clear-chromated

U		Packs of	Order No.	
			3	6
left		1	3687.776	3687.800
right		1	3687.743	3687.777

NEW

SUBRACKS COVERS HeiPac Vario COMPACT

Covers version 1



For all HeiPac Vario subracks

To cover the overall-subrack depth (EMC application) or as connector protection

- Flat design for top and bottom
- Optionally solid or perforated
- For mounting on the subrack side panel with the aid of mounting blocks

Material

1.0 mm aluminium, unplated, hole diameter 4 mm in perforated version.

Supply includes

1 cover plate

Note

For EMC applications, additional mounting blocks must be fitted across the entire subrack depth.

			Order No.	
			Single piece	
HP	For side panel depth (T) mm	Cover depth (d1) mm	Perforated	Solid
21	225	192	3687.618	3687.620
21	285	252	3687.619	3687.621
42	225	192	3687.623	3687.627
42	285	252	3685.642	3687.629

+ Also required

Mounting blocks, see page 148
EMC gaskets for cover plates, see page 147
Assembly screws, packs of 100, order no. 3684.233
see page 202

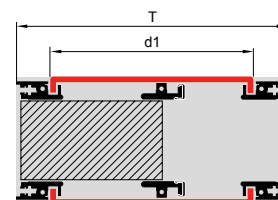
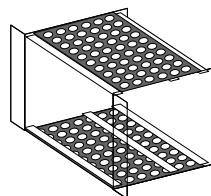

Covers version 2

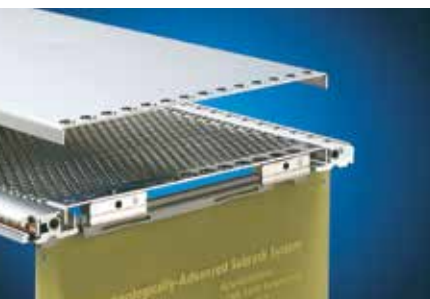

For all HeiPac Vario subracks

To cover the PCB depth

- Flat design for top and bottom
- Optionally solid or perforated
- For mounting on the subrack side panel with the aid of mounting blocks

Material

1.0 mm aluminium, unplated, hole diameter 4 mm in perforated version

Supply includes

1 cover plates

			Order No.	
			Single piece	
HP	For side panel depth (T) mm	Cover depth (d1) mm	Perforated	Solid
21	160	142	3687.630	3687.634
21	220	202	3687.631	3687.635
42	160	142	3684.957	3687.626
42	220	202	3687.633	3687.637

+ Also required

Mounting blocks, see page 148
Assembly screws, packs of 100, order no. 3684.233
see page 202

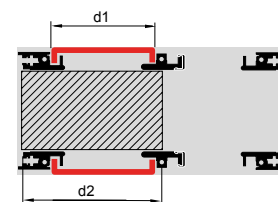
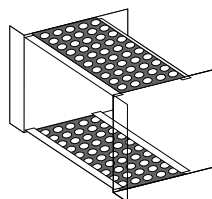

Top-hat rail adapter



NEW

Top-hat rail adapter to directly mount a component or device on a top-hat rail

Material

Extruded aluminium section

Packs of	Order No.
1	3687.739

+ Also required

Assembly screws ,packs of 100
Order no. 3606.550
see page 202

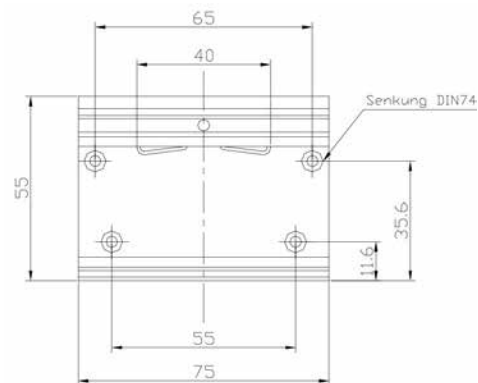

Back panel for top-hat rail mounting

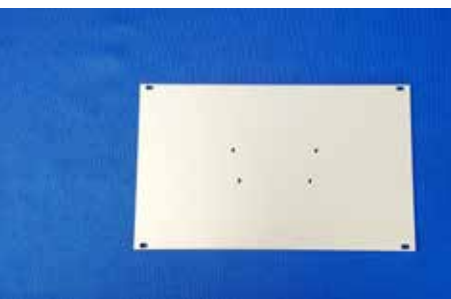

NEW

For HeiPac Vario COMPACT subracks

For top-hat rail mounting of subracks

Material

Aluminium, clear-chromated

		Order No.	
U		3	3
Width HP	Packs of	Non-EMC	EMC
21	1	3687.742	3687.750
42	1	3687.744	3687.751

+ Also required

Top-hat rail adapter, packs of 1
Order no. 3687.739
see page 75

Additional accessories see page

- EMC Accessories** → 146
- Guide rails** → 154
- Front panels** → 165
- Mounting kits** → 150
- Assembly parts** → 202

SUBRACKS

HeiPac Vario HEAVY

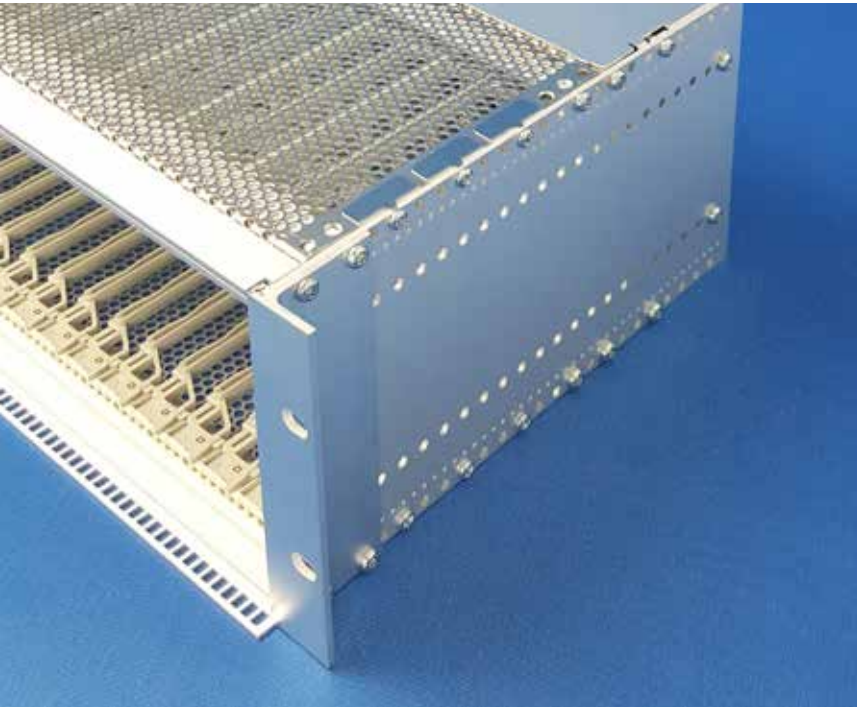

For mobile applications and tough ambient conditions

Applications

The HeiPac Vario HEAVY is a subrack system designed especially for mobile applications and tough ambient conditions.

The subrack system is shock and vibration-tested in accordance with EN 50 155 and DIN EN 61587-2, and is designed to accommodate standardised PCBs.

Technical specifications

- rack-mount system in accordance with IEC 60 297-3
- 3 and 6 U
- Clear-chromated aluminium side panels
- For card formats up to 220 mm deep
- Front horizontal rails with 10 mm extension for injector/extractor handles
- Horizontal rails with double screw fastening
- Reinforced mounting flange
- Rear equipment for installation of backplanes
- Installation width: 84 HP

Benefits at a glance

- Side panels with 10 mm mounting grids for variable system assembly
- For mounting backplanes
- Optionally in EMC version

NEW



Extensive accessories allow for a wide range of expansion options

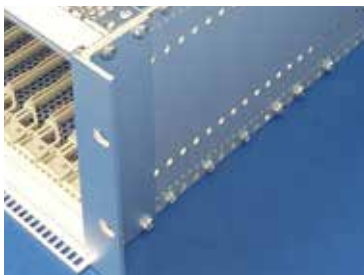

Horizontal rails with double screw fastening provide high mechanical strength



Reinforced flange ensures high resistance to shock and vibrations

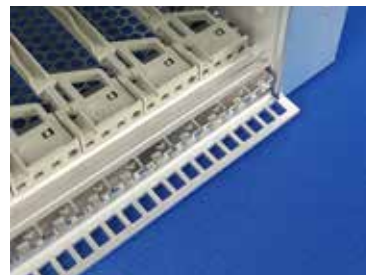

EMC can be retrofitted

Shock/vibration profile HeiPac HEAVY

Shock/vibration testing in accordance with : IEC 61587-1

DL2V/DL2S for use in different locations

Shock/vibration testing in accordance with : EN 50155

EN 61373, category 1, class B

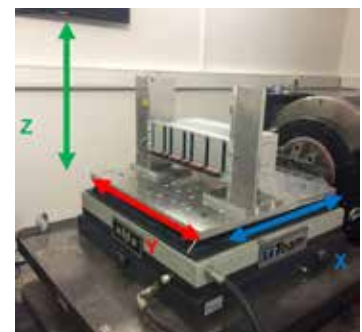

HeiPac Vario HEAVY 3 U, 6 U

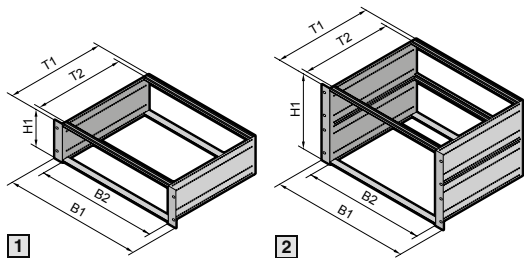
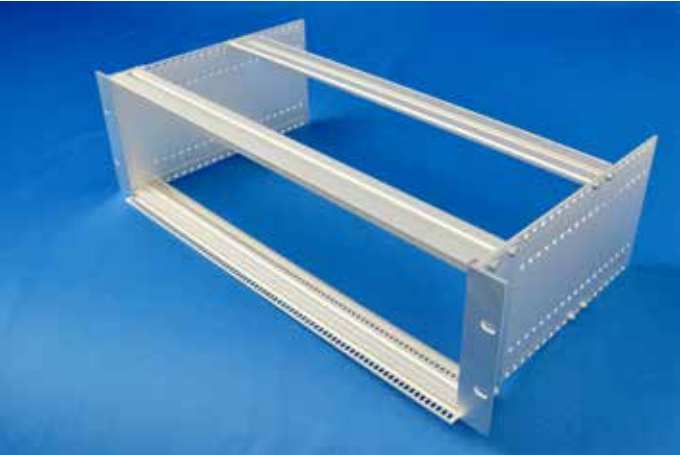

Material/surface finish

Side panels: 2.5 mm Aluminium, clear-chromated
 Horizontal rails: Extruded aluminium section, clear-chromated
 Flanges: Extruded aluminium section, clear-chromated

Supply includes

Side panels, flanges, horizontal rails, threaded inserts, assembly screws

Tests

Shock and vibration tested in accordance with:
 DIN EN 61587-2
 EN 50 155

Standards

HeiPac subracks are based on the system dimensions of IEC 60 297-3.

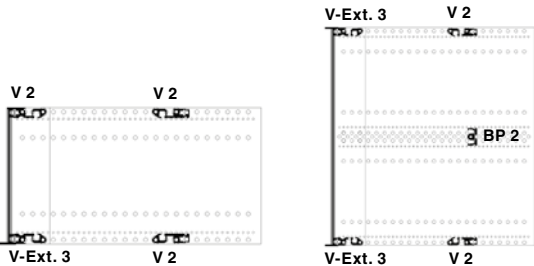

			Order No. without handle holes		Order No. with handle holes	
			1	2	1	2
U			3	6	3	6
Height (H1) mm			132	265.35	132	265.35
HP			84	84	84	84
Side panel (T1) mm	T2 mm	Max. PCB depth mm				
245	220	160	9921.860	9921.862	9921.864	9921.866
305	280	220	9921.861	9921.863	9921.865	9921.867

Other customised subrack solutions are available upon request. Please get in contact with one of our sales representatives for further assistance: Tel. +49 9126 - 29 34 0

SUBRACKS

HORIZONTAL RAILS HeiPac Vario HEAVY

Horizontal rail Vario V 2, front, with double screw fastening



To accommodate guide rails and for the attachment of front panels. The double screw fastening ensures a high level of stability even under extreme loads.

- Front projection 2.5 mm corresponding to IEC 60 297-3-101
- HP pitch pattern of holes for the precise installation of guide rails
- M4 thread on end face
- Straight-through core hole
- Load test to DIN EN/IEC 61 587-1, requirement level SL1
- Shock and vibration tests undertaken as per IEC 61 373 (DIN EN 50 155), Category 1, Class B

Material

Extruded aluminium section

Surface finish

Clear-chromated

Usable width (HP)	Packs of	Order No. unprinted	Order No. printed
84	1	9908.721	9921.793 ¹⁾

¹⁾ with HP pattern printing

+ Also required

Assembly screws M4 x 12
Packs of 100, order no. 3654.300
see page 202

+ Accessories

Threaded inserts, packs of 1
order no. 3684.610
see page 144

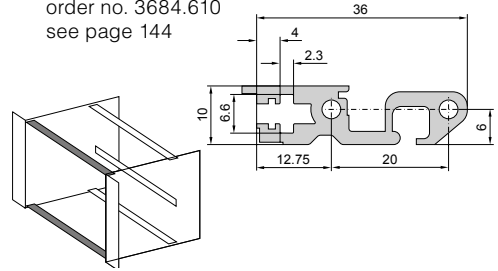

Horizontal rail Vario V-Ext. 3, with 10 mm extension and double screw fastening, front



For type IV, IVs and VII injector/extractor handle

To accommodate guide rails and for the attachment of front panels. The double screw fastening ensures a high level of stability even under extreme loads.

- Front projection 10 mm corresponding to IEEE 1101.10 and IEC 60 297-3-102
- HP pitch pattern of holes for the precise installation of guide rails
- M4 thread on end face
- Straight-through core hole

Material

Extruded aluminium section

Surface finish

Clear-chromated

Usable width (HP)	Packs of	Order No. unprinted	Order No. printed
84	1	9908.722	9921.795 ¹⁾

¹⁾ with HP pattern printing

+ Also required

Assembly screws M4 x 12
Packs of 100, order no. 3654.300
see page 202

+ Accessories

Threaded inserts, packs of 1, order no. 3684.610
see page 144

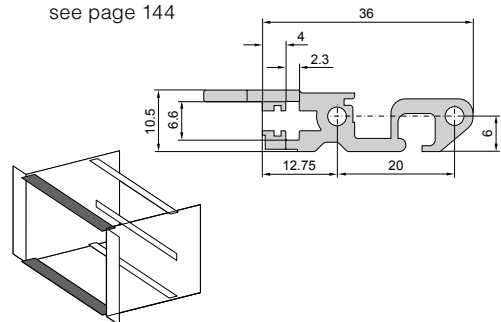

Horizontal rail Vario BP 2, for backplane



To accommodate guide rails and for the attachment of Z rails, insulating strips or conductive strips. The double screw fastening ensures a high level of stability even under extreme loads.

- HP pitch pattern of holes for the precise installation of guide rails
- M4 thread on end face
- For mounting backplanes/Z rails additional threaded inserts (9901.816) are required
- Straight-through core hole

Material

Extruded aluminium section

Surface finish

Clear-chromated

Usable width (HP)	Packs of	Order No.
84	1	9908.723

+ Also required

Assembly screws M4 x 12
Packs of 100, order no. 3654.300
see page 202

+ Accessories

Threaded inserts, packs of 1, order no. 9901.816
see page 144

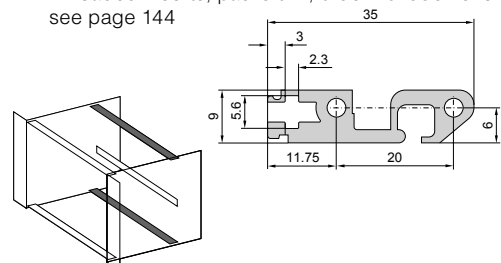

Side panels for HeiPac Vario

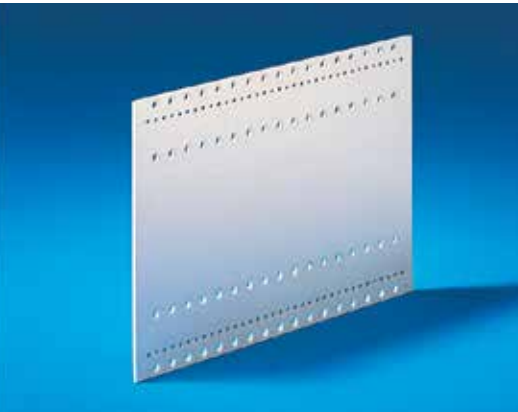

Mounting holes and anti-twist half-shears on a 10 mm pitch pattern.

Material

2.5 mm Aluminium
Clear-chromated

			Order No.	
U		Packs of	3	6
T mm	a ¹⁾ mm			
245	220	1	3684.513	3684.531
305	280	1	3684.515	3684.533

¹⁾ a = Distance between the first and last mounting hole.

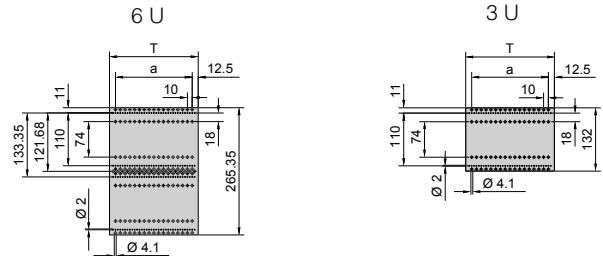

Reinforced flanges 19" for HeiPac Vario

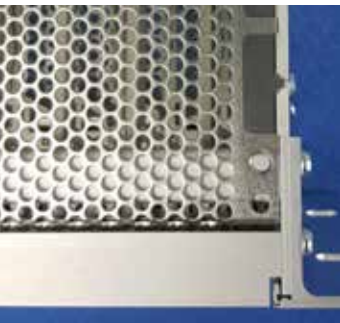

Reinforced flange ensures a high level of stability even under extreme loads.

Material

Extruded aluminum section
3 mm material thickness

Surface finish

Clear-chromated

U	Packs of	with handle holes	Order No.	without handle holes
3	1	9921.725	9914.268	9914.268
6	1	9921.726	9921.721	9921.721

+ Accessories

Handles for subrack
see page 81

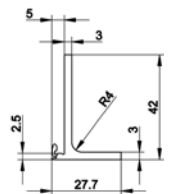
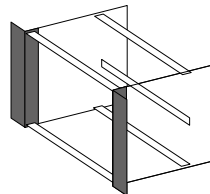

NEW

Mounting clips for cover plates

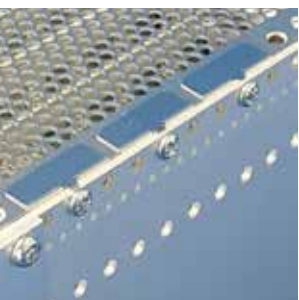

For mounting covers on the sub-rack side panel

Compatible with cover plate versions 1-4 and the ECO and EASY versions, and with sheet metal blanks 0.8-1.0 mm thick. For EMC applications, mounting clips must be fitted across the full depth of the subrack.

Material

Stainless steel

Length mm	n	Packs of	Order No.
30	1	1	3688.109
90	3	1	9921.722
120	4	1	9921.883
150	5	1	9921.723
180	6	1	9921.884
210	7	1	9921.724
240	8	1	9921.885

+ Also required

Assembly screws, order no. 9921.879

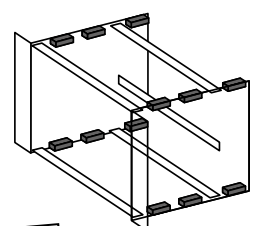
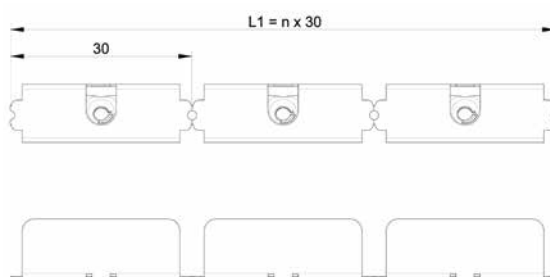

EMC

NEW

SUBRACKS COVERS HeiPac Vario HEAVY

Covers version 1



For all HeiPac Vario subracks

To cover the overall-subrack depth
(EMC application) or as connector protection

- Flat design for top and bottom
- Optionally solid or perforated
- For mounting on the subrack side panel with the aid of mounting blocks

Material

1.0 mm aluminium, unplated, hole diameter 4 mm in perforated version.

Supply includes

1 cover plate

Note

For EMC applications, additional mounting blocks must be fitted across the entire subrack depth.

			Order No.	
			Single piece	
HP	For side panel depth (T) mm	Cover depth (d1) mm	Perforated	Solid
84	245	212	3684.695	3684.684
84	305	272	3685.852	3684.686

+ Also required

Mounting blocks, see page 148

EMC gaskets for cover plates, see page 147

Assembly screws, packs of 100, order no. 3684.233, see page 202

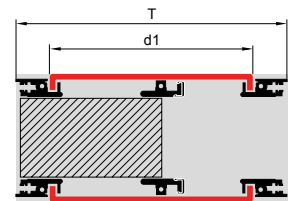
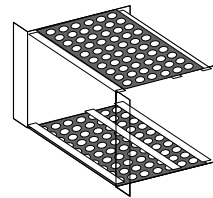

Covers version 2

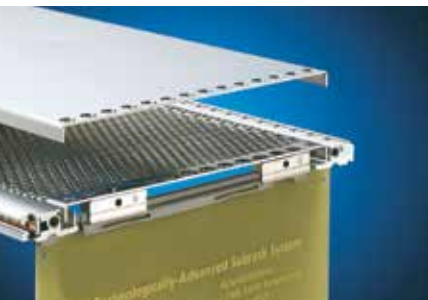

For all HeiPac Vario subracks

To cover the PCB depth

- Flat design for top and bottom
- Optionally solid or perforated
- For mounting on the subrack side panel with the aid of mounting blocks

Material

1.0 mm aluminium, unplated, hole diameter 4 mm in perforated version

Supply includes

1 cover plates

			Order No.	
			Single piece	
HP	For PCB depth (d2) mm	Cover depth (d1) mm	Perforated	Solid
84	160	142	3684.681	3684.680
84	220	202	3685.851	3685.813

+ Also required

Mounting blocks, see page 148

Assembly screws, packs of 100, order no. 3684.233, see page 202

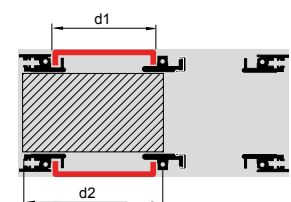
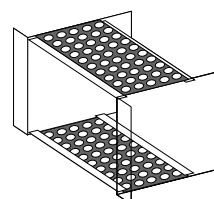

Back cover for HeiPac Vario

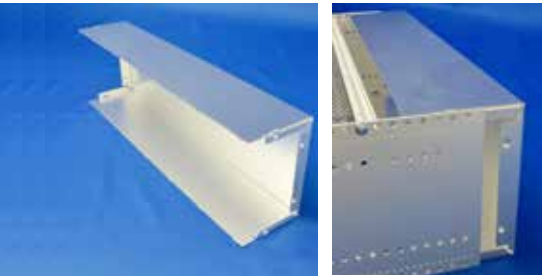

NEW

Ensures cover for back of subrack

Material

Aluminium

Surface finish

Clear-chromated

Note

The side panel depth required is obtained by taking the length of the plug-in units used, and adding 85 mm (refer to table).

A precondition is the use of a horizontal rail that allows room for additional construction.

U	Packs of	Order No.
3	1	9921.685
6	1	9921.710

PCB depth mm	Side panel depth mm
160	245
220	305
280	365

Horizontal rail that allows room for additional construction

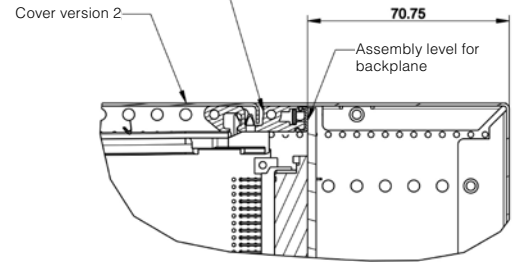

Handles for HeiPac subracks



For fitting on the subrack flange with handle holes and on all component shelves.

Material

Die-cast zinc

Supply includes

Assembly parts

Surface finish

Spray-finished, silver-grey

For	L1	L2	Packs of	Order No.
Subracks 3 U and 4 U	114.5	130.5	2	3636.010
Subracks 6 U and 7 U	248	264	2	3666.010

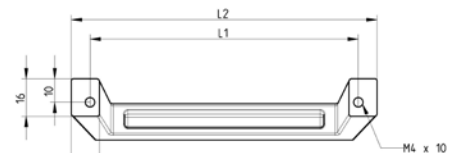

Additional accessories see page

- EMC Accessories** → 146
- Guide rails** → 154
- Front panels** → 165
- Mounting kits** → 150
- Assembly parts** → 202

SUBRACKS

HeiPac EASY



Economical, sturdy 19" subrack system

Applications

Subrack system for standard applications or high mechanical loads. In cases that require easy handling and fast assembly. Suitable for installation of standardised PCBs or plugin units up to 400 mm depth.

Technical specifications

- 482.6 mm (19") subrack according to IEC 60 297-3
- 3 and 6 U
- For board depths: 160 mm, 220 mm, 280 mm, 340 mm, 400 mm
- Fast and easy assembly due to pre-assembled screws and longitudinal holes in the side panels
- Top covers easily retractable
- Horizontal rails with double screwed joint
- Material: aluminium, noncorrosive
- 60 mm mounting grids for horizontal rails
- Rear horizontal rails with integrated contact surface
- Rear equipment for installation of backplanes or connectors
- Separate 19" flanges

Benefits at a glance

- Fast and easy handling by pre-assembled screws in the horizontal rails
- Top covers retractable
- Horizontal rails with integrated contact surface (insulating strips cannot be used)
- Double screw joints of horizontal rails ensure stability even for high loads



Rails with double screw for heavy loads



Top covers easily to retract



Horizontal rails with optional double screwing ensure a higher mechanical resistance



EASY to handle and yet extremely versatile

Requirement Profile HeiPac EASY

EN 61587-1; Requirement Category C2

Climatic tests: cold, dry and damp heat, cyclic

EN 61587-1; Requirement Category A1

Industrial climate

IEC 61587-1; Requirement Category SL1

Mechanical tests: mechanical loads (static)

IEC 61587-1; Requirement Category DL1

Mechanical loads, industrial applications (dynamic)

HeiPac EASY 3 U, 6 U, Aluminium

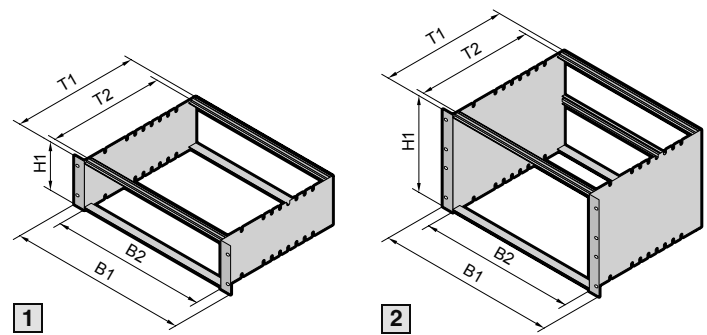

Material/surface finish

Side panels: 2 mm aluminium, unplated
Horizontal rails: extruded aluminium section, noncorrosive
Flanges: pre-anodised

Supply includes

Side panels, flanges, horizontal rails incl. pre-mounted threaded inserts and assembly screws

Tests

Shock- and vibration tested to:
IEC 600-68-2-6 test Fc
IEC 600-68-2-27 test Ea

Standards

HeiPac subracks are based on the system dimensions of IEC 60 297-3

Note

Backplanes can be mounted directly on the rear horizontal rails. Isolating strips cannot be used.

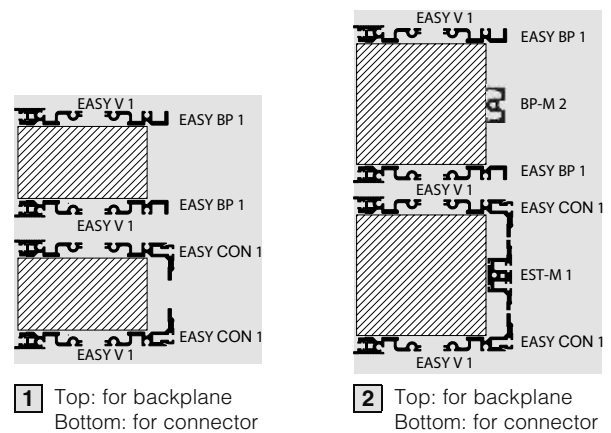

					Order No.			
					1		2	
U (H1)					3		6	
B1 mm	B2 HP	Side panel (T1) mm	T2 mm	Max. PCB depth mm	For backplane	For connector IEC 60 603-2	For backplane	For connector IEC 60 603-2
482.6 (19")	84	175	160	160	3634.100	3634.150	3634.180	3634.230
		235	220	220	3634.110	3634.160	3634.190	3634.240
		295	280	280	3634.120	3634.170	3634.200	3634.250
		355	340	340	3634.130	-	3634.210	-
		415	400	400	3634.140	-	3634.220	-

Other customised subrack solutions are available upon request. Please get in contact with one of our sales representatives for further assistance: Tel. +49 9126 - 29 34 0

In addition to the presented subrack-kits, we offer components and accessories for your individual configuration on the following pages.

WE MEET YOUR INDIVIDUAL NEEDS!

You are looking for a product in the field of electronic packaging that is not in our catalogue? Please contact us! Due to our extensive range of services we can meet all your demands.







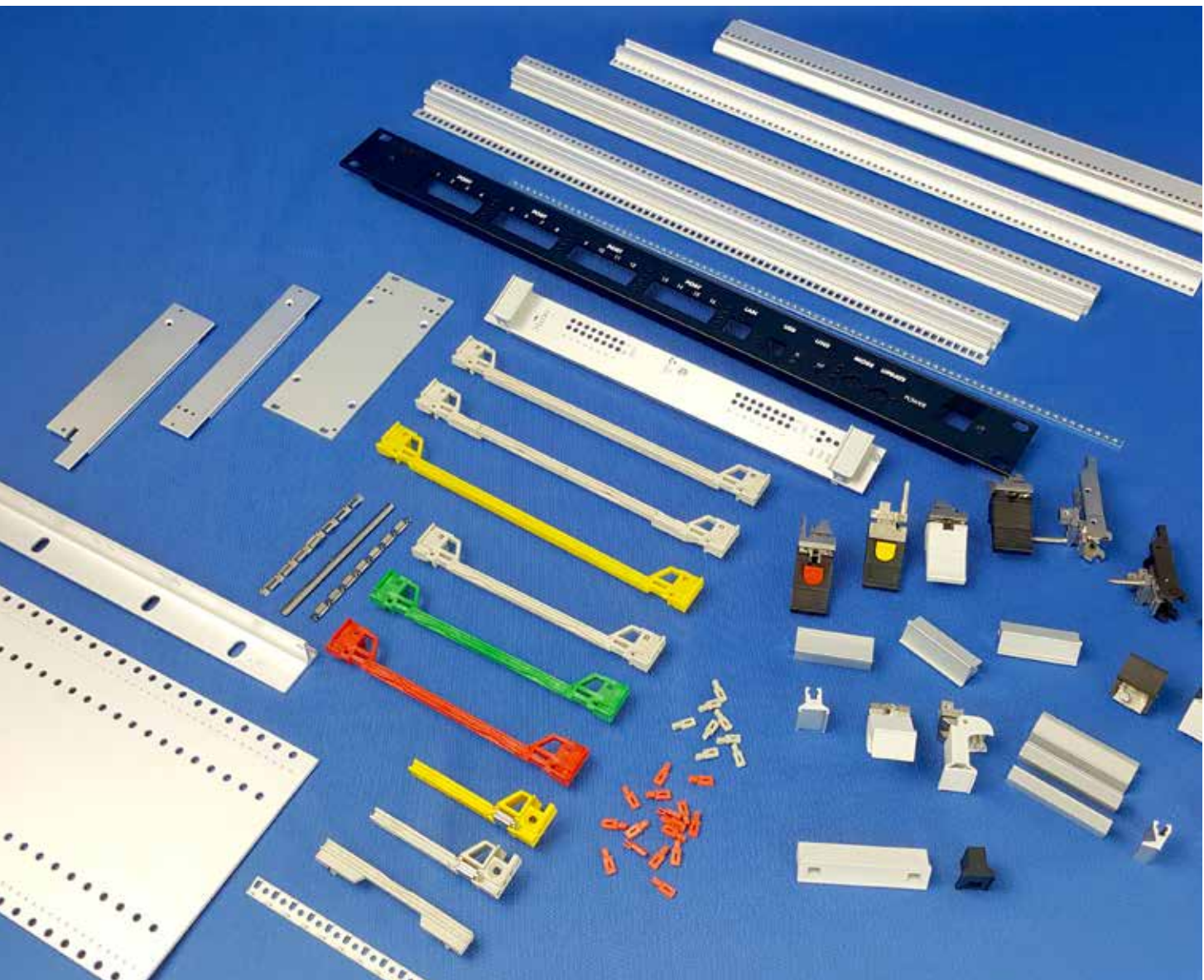











We will gladly submit a tailored quotation.

Phone: 09126 - 29 34 0

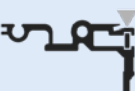

E-Mail: eps-quote@heitec.de



Overview horizontal rails HeiPac EASY

Main sections	EASY V 1 Front horizontal rail, with double screw fastening	EASY BP 1 Rear horizontal rail, with double screw fastening, for mounting backplanes	EASY CON 1 Rear horizontal rail, with double screw fastening, with integral Z rail	Vario CON-M 1 Rear horizontal rail, with integral Z rail	Vario BP-M 2 Rear horizontal rail, centre	EASY H 1 Rear horizontal rail, with double screw fastening, for mounting rear panels
	Page 86	Page 88	Page 87	Page 88	Page 86	Page 87
Additional sections						
E Adaptor rail, rear centre, to accommodate guide rails  Page 140	-	-	-			-
F Z rail for connector  Page 144	-	-	-	-	-	-
G Insulating strip ¹⁾  Page 145	-	-	-	-	-	-
H Conductive strip ²⁾  Page 145	-	-	-	-	-	-
I Threaded insert  Page 144		-			-	
J Identification strips  Page 144	-	-	-	-	-	-
K EMC gaskets, horizontal  Page 145	-	-	-	-	-	-

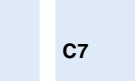
For ¹⁾insulated or ²⁾conductive attachment of backplanes.

Description old	Description new	Main sections	Description old	Description new	Main sections
A	V 1		C7	CON 1	
A1	BP 1		-	H 1	

SUBRACKS

HORIZONTAL RAILS HeiPac EASY

Horizontal rail EASY V 1, with double screw fastening, front



To accommodate guide rails and for the attachment of front panels

- Pre-assembled screws M 4x16 for fast mounting on the subrack side panel
- Front excess length 2.5 mm corresponding to IEC 60 297-3
- HP pitch pattern of holes for the precise installation of guide rails
- On request with double screw fastening to ensure a high stability
- M4 thread on end face
- Straight-through core hole for optional double screw fastening

Material

Extruded aluminium section

Surface finish

Non-corrosive

Supply includes

2 horizontal rails with pre-assembled threaded inserts and screws M4 x 16

Usable width (HP)	Packs of	Order No. unprinted	Order No. printed
84	2	3634.600	9921.803 ¹⁾

¹⁾ with HP pattern printing

+ Also required

Assembly screws M4 x 16 for double screw fastening, order no. 3634.430 (packs of 100)

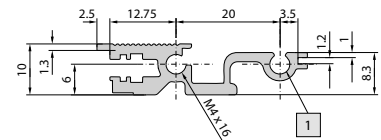
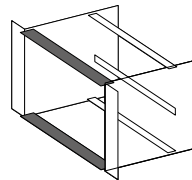

1 Core hole M4

Horizontal rail Vario BP-M 2, for backplane, centre

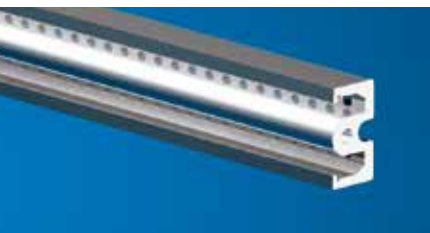

When using 6 U PCBs or box-type plug-in units. Facility for the attachment of Z rails or backplanes.

- Tapped holes M2.5
- M4 thread on end face
- Straight-through core hole
- Due to integrated contact area, insulating strips cannot be used

Usable width (HP)	Packs of	Order No.
84	1	9912.523

Material

Extruded aluminium section

Surface finish

Clear-chromated

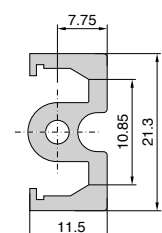
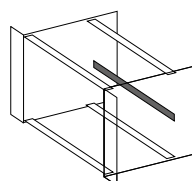

Horizontal rail EASY H 1, with double screw fastening, for mounting rear panels



To accommodate rear front panels

- With channel for mounting top covers see page 164 Covers EASY version 2
- On request with double screw fastening to ensure a high stability
- Straight-through core hole for optional double screw fastening
- M4 thread on end face
- Pre-assembled screws M 4x16 for fast mounting on the subrack side panel

Material

Extruded aluminium section

Surface finish

Non-corrosive

Supply includes

2 horizontal rails with threaded inserts and screws M4 x 16

Usable width (HP)	Packs of	Order No.
84	1	3634.510

+ Also required

Assembly screws M4 x 16 for double screw fastening, order no. 3634.430 (packs of 100)

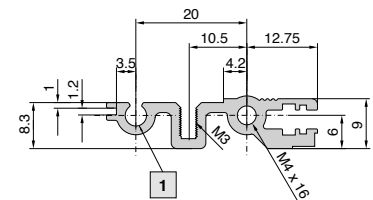

1 Core hole M4

Horizontal rail EASY CON 1, with integral Z rail for connector, with double screw fastening



To accommodate guide rails, integral Z rail for the attachment of connectors (CON)

- Pre-assembled screws M 4x16 for fast mounting on the subrack side panel
- On request with double screw fastening to ensure a high stability
- HP pitch pattern of holes for precise mounting of guide rails
- M4 thread on end face
- Straight-through core hole for optional double screw fastening
- Height of the profile allows cover extension

Material

Extruded aluminium section

Surface finish

Non-corrosive

Supply includes

2 horizontal rails with pre-assembled screws M4 x 16

Usable width (HP)	Packs of	Order No.
84	2	3634.620

+ Also required

Threaded inserts, packs of 1, order no. 9901.816 see page 144

+ Also required

Assembly screws M4 x 16 for double screw fastening, order no. 3634.430 (packs of 100)

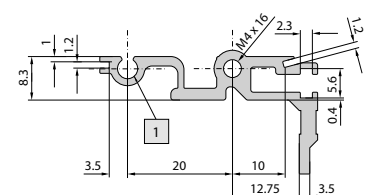
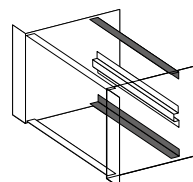

1 Core hole M4

SUBRACKS

HORIZONTAL RAILS HeiPac EASY

Horizontal rail EASY BP 1, with double screw fastening, for backplane



To accommodate guide rails and for the attachment of backplanes

- Pre-assembled screws M 4x16 for fast mounting on the subrack side panel
- Due to integrated contact area, insulating strips cannot be used
- Tapped holes M2.5 in 1 HP pitch pattern for mounting backplanes
- HP pitch pattern of holes for the precise installation of guide rails
- On request with double screw fastening to ensure a high stability
- M4 thread on end face
- Height of the profile allows cover extension
- Straight-through core hole for optional double screw fastening

Material

Extruded aluminium section

Surface finish

Non-corrosive

Supply includes

2 horizontal rails with pre-assembled threaded inserts and screws M4 x 16

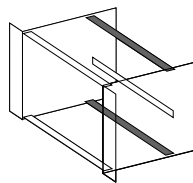

Usable width (HP)	Packs of	Order No.
84	2	3634.615

+ Also required

Assembly screws M4 x 16 for double screw fastening, order no. 3634.430 (packs of 100)

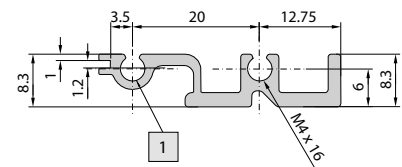

1 Core hole M4

Horizontal rail Vario CON-M 1, with integral Z rail for connector, rear centre



When using 6 U PCBs or box-type plug-in units. Integral Z rail for mounting connectors (CON) to IEC 60 603-2

- Tapped holes M2.5
- M4 thread on end face
- Straight-through core hole

Material

Extruded aluminium section

Surface finish

Anodised

Supply includes

1 horizontal rail
2 assembly screws

Usable width (HP)	Packs of	Order No.
84	1	3634.085

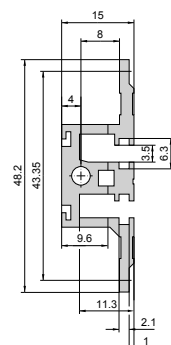
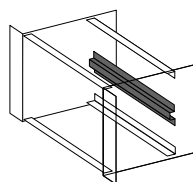

Side panels for HeiPac EASY

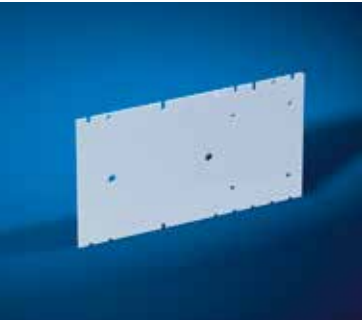

Mounting holes on a 60 mm pitch pattern as long holes
Drill holes for mounting telescopic slides

Material

2 mm Aluminium
Non-corrosive

- 1 Mounting holes suitable for threaded insert PEM-FM4-1 for mounting telescopic slides

d (T) mm	L2	n	n1	Packs of	Max. board depth mm	Order No.	
						3 U	6 U
175	-	-	-	2	160	3634.695	3634.720
235	60	-	-	2	220	3634.700	3634.725
295	60	2	2	2	280	3634.705	3634.730
355	60	3	3	2	340	3634.710	3634.735
415	60	4	3	2	400	3634.715	3634.740

+ Accessories

Flanges for HeiPac EASY
see page 129

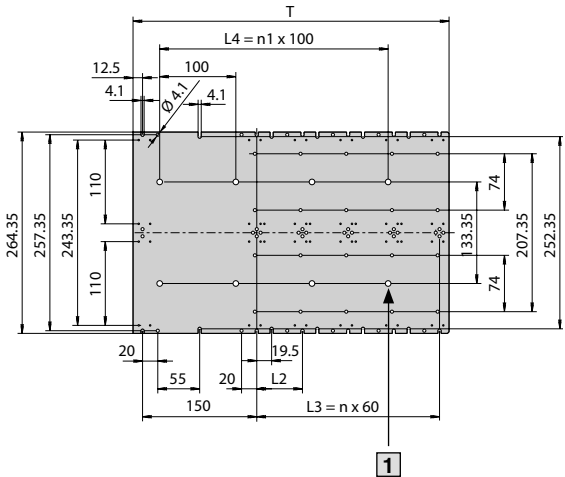
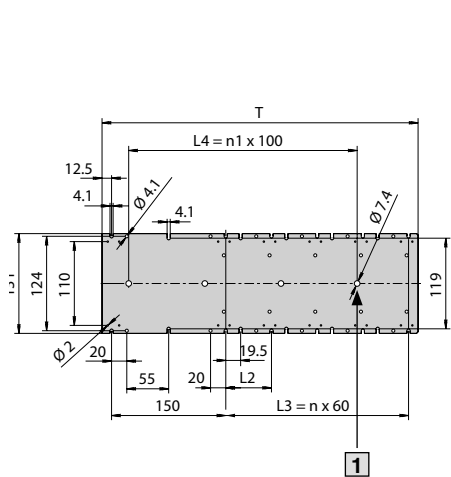

Flanges 19" for HeiPac EASY



Integrated mounting holes for installation of handles

Material

Extruded aluminium profiles

Surface finish

Pre-anodised

U	Packs of	Order No.
3	2	3634.745
6	2	3634.750

+ Accessories

Handles for subrack
see page 90

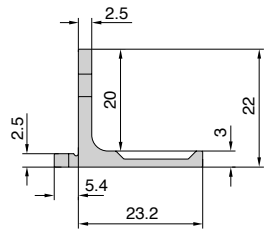

SUBRACKS RECOMMENDED ACCESSORIES HeiPac EASY

Covers for HeiPac EASY



- Perforated or solid
- Optionally with screwed fastening clips on the side panels for additional support

Material

Aluminium

Supply includes

2 cover plates

Cover plates

version 1 (slide-in)

The covers are simply slid into the front and rear horizontal rails for mounting backplanes/connectors.

version 2 (slide-in/screw-in)

For mounting additional rear horizontal rails on the rear panels. The horizontal rails for backplane/connector assembly are top-mounted. The covers are slid in the front horizontal rails and screwed in the rear horizontal rails for rear panel mounting.

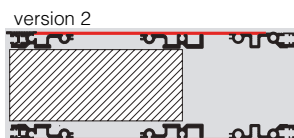
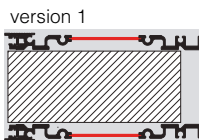

Version 1

HP	For side panel depth mm	Order No.	
		Perforated	Solid
84	175	3634.685	3634.675
84	235	3634.690	3634.680

Version 2

HP	For side panel depth mm	Order No.	
		Perforated ¹⁾	Solid ¹⁾
84	175	3634.650	3634.625
84	235	3634.655	3634.630
84	295	3634.660	3634.635
84	355	3634.665	3634.640
84	415	3634.670	3634.645

+ Also required

¹⁾ assembly screws, packs of 100
order no. 3684.233
see page 202

+ Accessories

Fastening clips
see page 148

Fastening clips

Packs of	Order No.
50	3634.450

Assembly screws for fastening clips

Packs of	Order No.
100	9921.879

Handles for HeiPac subracks



For fitting on the subrack flange with handle holes and on all component shelves.

Material

Die-cast zinc

Supply includes

Assembly parts

Surface finish

Spray-finished, silver-grey

For	L1	L2	Packs of	Order No.
Subracks 3 U and 4 U	114.5	130.5	2	3636.010
Subracks 6 U and 7 U	248	264	2	3666.010

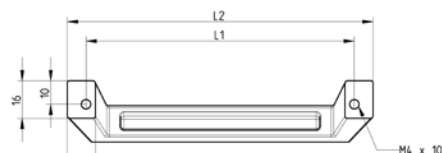

Fixing for HeiPac top-hat rail version 1

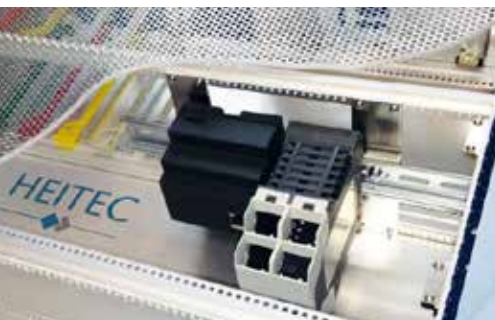

NEW

Rail holder to mount a top-hat rail on the horizontal subrack rails

Material

Rail holder: Aluminium, not surface-coated
Top-hat rail: steel, zinc-plated

Supply includes

2 rail holders
1 top-hat rail, perforated
Assembly parts

Height	HS	L1	L2	Packs of	Order No.
3 U	35	100	7.5	1	9918814
3 U	35	200	7.5	1	9918815
3 U	35	300	7.5	1	9918816
3 U	35	400	7.5	1	9918817
3 U	35	100	15	1	9918818
3 U	35	200	15	1	9918819
3 U	35	300	15	1	9918820
3 U	35	400	15	1	9918821

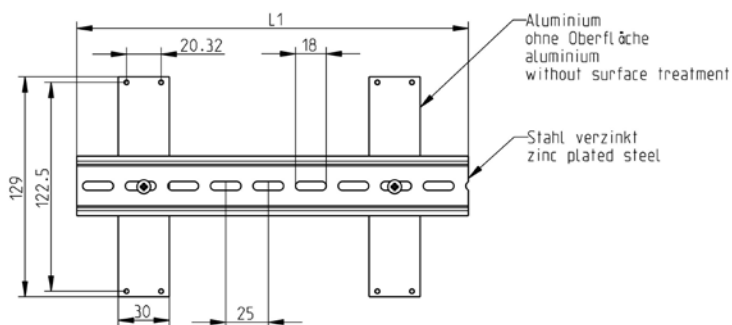

Fixing for HeiPac top-hat rail version 2



NEW

Fixing bracket to mount a top-hat rail on the subrack side panel

Material

Fixing bracket: steel plate, zinc-plated

Supply includes

2 fixing brackets
Assembly parts

Packs of	Order No.
1 set	3634.770

+ Also required

Top-hat rail, packs of 1, see page 91

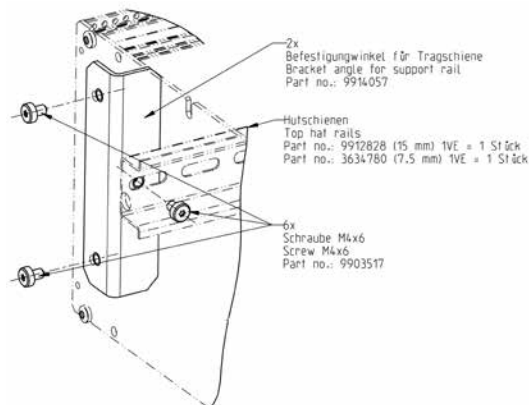

Top-hat rail



NEW

Material

Steel

Surface finish

Zinc-plated

For Width	Dimensions mm	Packs of	Order No.
84 HP	35 x 7.5 x 425	1	3634.780
84 HP	35 x 15 x 425	1	9912.828

Additional accessories see page

- Guide rails** → 154
- Assembly parts** → 202

SUBRACKS APPLICATION EXAMPLE

Industrial Control

Customised chassis solution for grinder control device

Industrial environments are typically characterised by harsh ambient conditions. This was why one of HEITEC's customers in the automation field needed a customised system platform to accommodate the control mechanism for the central processing unit of a grinder. Right at the outset, the customer had opted for a solution in the 19-inch range, since 19"-specific units had to be built in to the chassis.

For its solution, HEITEC designed a low-cost sheet metal casing that was powder-coated to provide protection against harsh ambient conditions and humidity. In addition, to guarantee a particularly high level of protection (IP54) against dust and humidity, PU foam seals were used for the front and rear plates. These provide a secure seal even under very harsh ambient conditions. The optimised design meant that other adaptations to the chassis, such as openings in the cover plate for wiring ducts, were also achievable at a modest cost. As a result, the chassis developed by HEITEC for its customer was ideally suited to the customer's requirements, combining maximum space availability with the most precise wire routing for the customer's application, and ensuring very high IP protection.

Inside the casing, the familiar HeiPac Vario rack components were used to meet the customer's expectations. The HeiPac Vario series is the most variable 19-inch rack family offered by HEITEC: its many size variations and accessories make it ideally suited for even the most complex applications.

To ensure very short delivery times, this project drew on systematic warehousing offered by HEITEC, which offers the customer great flexibility combined with guaranteed delivery capacity. When blanket orders are placed, this enables the logistics and customer call-off orders to be perfectly coordinated.

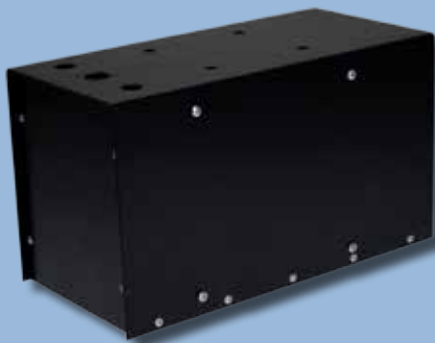

Technical Summary

- Customer-specific system platform
- Customised rack with internal structure consisting of standard HeiPac Vario components
- L x W x H: 296 mm x 30HP x 4U
- LP card brackets = 160 x 2.00 mm
- Protection class IP54

Customer Benefits

- Customised rack for a customer-specific system
- Powder coating and PU foam seals on front and back plates provide very high protection against harsh ambient conditions
- Fully prefabricated system platform for PCBs
- Cost-optimised design
- Short delivery times despite customer-specific manufacture

Transportation

Customised chassis solution for railway electrification control device

Applications for railway electrification are subject to stringent conditions. To deal with these, one of HEITEC's customers needed a customised system platform to accommodate the control mechanism for the central processing unit of a railway application.

For its solution, HEITEC designed a low-cost sheet metal casing that was painted to provide protection against harsh ambient conditions and humidity, and fitted with a thermoplastic front plate. The optimised design meant that other adaptations to the casing, such as openings in the cover plate for wiring connectors, were also achievable at a modest cost. As a result, the casing developed by HEITEC for its customer was ideally suited to the customer's requirements, combining maximum space availability with the most precise wire routing for the customer's application, and thus offering very good protection against harsh ambient conditions such as humidity, dust, high temperatures and vibrations. This was vital for the project, since the system was intended for use in the Australian desert and would have to cope with extreme changes in ambient conditions.

Inside the casing, the familiar HeiPac Vario rack components were used. The HeiPac Vario series is the most variable 19-inch rack family offered by HEITEC: its many size variations and accessories make it ideally suited for even the most complex applications.

Implementing the project depended on a number of specific criteria. Swift handling was essential – it took just a few weeks from the initial sketch to building a prototype and through to the test stage. It also had to offer very good value for money, and the optimised design made that possible.

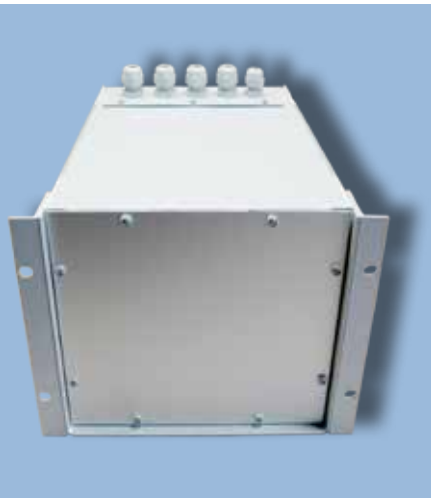

Technical Summary

- Customer-specific system platform
- Customised painted casing with internal structure consisting of HeiPac Vario components for a 7-slot backplane
- L x W x H: 325 mm x 42HP x 4U
- LP card brackets = 160 x 2.00 mm for seven single eurocards
- Macrolon front plate
- Protection class IP54
- 5 wiring connectors

Customer Benefits

- Customised rack for a customer-specific system
- Very high protection against harsh ambient conditions (IP54)
- Fully prefabricated system platform for PCBs
- Stable construction for rail-based vehicles ensures high resistance to shock and vibrations
- Good tolerance for high temperatures makes it ideal for use in desert transportation
- Very good protection against dust and moisture
- Cost-optimised design
- High service friendliness: rapid access and replacement

HEITEC Instrument Cases And System Enclosures

High Functionality And Modern Design

INSTRUMENT CASES AND SYSTEM ENCLOSURES



The HeiCase instrument case impresses with its modern design and high functionality. Particular features include the numerous colour variants and the all-metal enclosure construction. The HeiPac Vario-Module system enclosure (instrument case or rack-mount enclosure) is fully compatible with the latest HeiPac subrack range, making it ideal for individual configuration and assembly as a microcomputer system.

At just 1 U, the HeiBox system enclosure offers a high packaging density in the smallest space.

HeiBox ALU

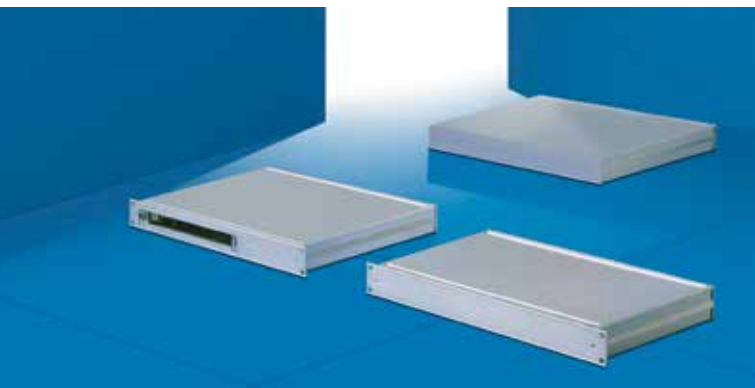

High-quality 1 U 19" system enclosure

- Optionally for use as an instrument case or rack-mount enclosure
- For horizontal installation of standardised 6 U boards
- For individual expansion
- High-quality design
- Extremely easy to assemble
- EMC upgradeable

→ Page 96

HeiBox ECO

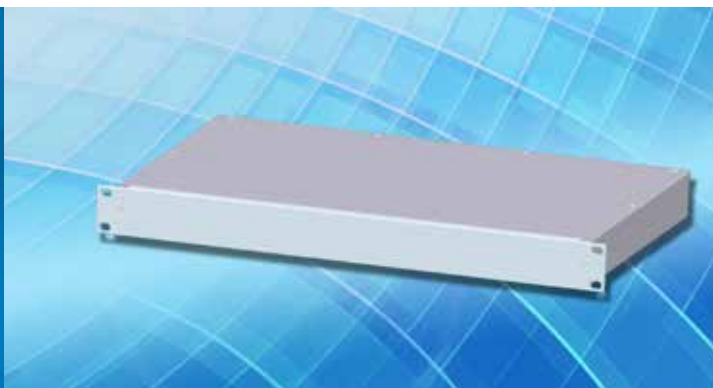

Well-priced 1 U 19" system enclosure

- Optionally for use as an instrument case or rack-mount enclosure
- For individual expansion
- EMC upgradeable

→ Page 98

HeiPac Vario-Module



Universal 19" system enclosure

- Optionally for use as an instrument case or rack-mount enclosure
- Varied selection of sizes
- Flexibel design options
- Wide range of accessories
- EMC upgradeable

→ Page 100

HeiCase



Universal instrument case

- Instrument case for the installation of 19"- slide-in assemblies and- elements
- For individual expansion
- Outstanding stability
- Varied selection of sizes
- Flexibel design options
- Wide range of accessories
- Modern design

→ Page 112

INSTRUMENT CASES AND SYSTEM ENCLOSURES

HeiBox ALU



Innovative system enclosure for standard applications

Applications

The HeiBox ALU is optionally for use as an instrument case or rack-mount enclosure. Accommodates Eurocards/ Double Eurocards (horizontal), bridges, hubs, routers or modems.

Technical specifications

- 19" system enclosure, complies with IEC 60 297-3
- Optionally for use as an instrument case or rack-mount enclosure
- Height: 1 U
- Installation width: 84 HP
- Optionally with mounting kit for 1 Double Eurocard
- Mounting plate (accessory) for individual population
- Extruded aluminium section
- Protection category IP 40

Benefits at a glance

- Minimum space requirement
- Easy and fast mounting
- High-quality design
- EMC upgradeable
- Individual assembly according to customer needs



Installation of standardised 6 U boards with mounting kit



Solid, high-quality design of extruded aluminium section

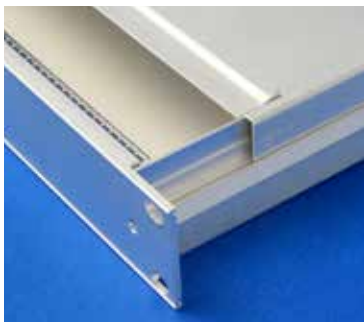

High EMC protection with additional EMC kit

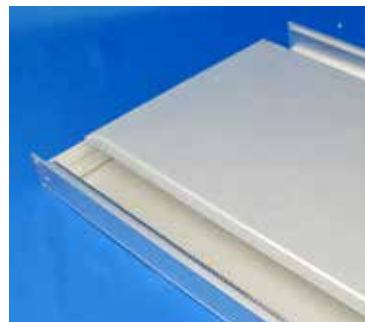

Easy to assemble with just 4 screws

HeiBox system enclosure 1 U

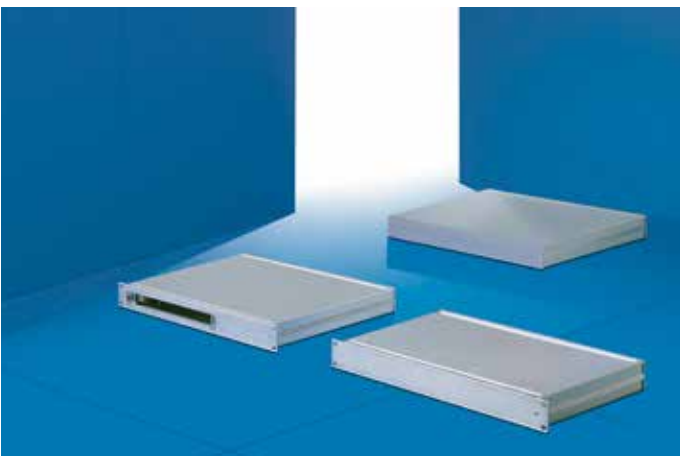

B = Width
T = Depth
HE = U

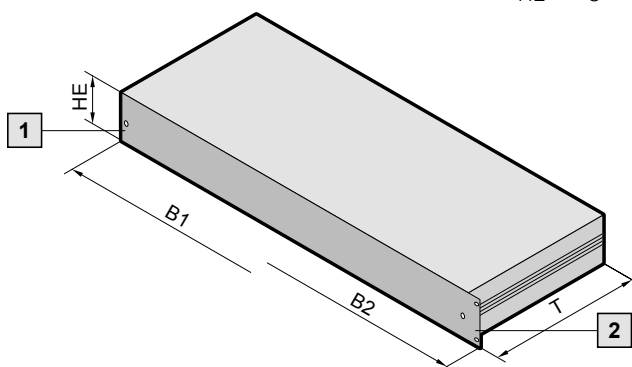

Technical specifications

System enclosures 1 U, 150, 200, 250, 300, 350 mm deep. Easy to assemble with just 4 screws. Optionally for use as an instrument case or 19" rack-mount enclosure. Front panel to hold an overlay to conceal the screws. Maximum interior space. Optional EMC upgrades with additional EMC gaskets. Option of installing electronic boards such as 1 VME or CPCI board horizontally.

Design

System enclosure 1 U, to IEC 60 297-3. Optionally available for 19" rack-mounting in the enclosure or as an instrument case version.

- 1** Equipped as an instrument case
- 2** Equipped as a rack-mount unit

Material/surface finish

Side panels: Extruded aluminium section, untreated
 Base/cover trays: Aluminium, clear-chromated
 Front/rear panel: Extruded aluminium section, clear-chromated
 Mounting plate : Aluminium

U	1	1	1	1	1	-	-
Width (B1) mm	447	447	447	447	447	-	-
Width (B2) mm	482.6 (19")	482.6 (19")	482.6 (19")	482.6 (19")	482.6 (19")	482.6 (19")	482.6 (19")
Depth (T) mm	150	200	250	300	350	250	350
Model No. instrument case	3687.819	3687.820	3687.821	3687.822	3687.823	-	-
Model No. rack case	3687.814	3687.815	3687.816	3687.817	3687.818	-	-
Model No. rack-mount including mounting kit for double Euroboards	-	-	-	-	-	3684.072	3684.073
Supply includes							
Side panel	2	2	2	2	2	2	2
Front panel	1	1	1	1	1	1	1
Rear panel	1	1	1	1	1	1	1
Base/cover tray	2	2	2	2	2	2	2
Mounting kit	-	-	-	-	-	1	1
Accessories							
EMC set	9919.999	9919.999	9919.999	9919.999	9919.999	9919.999	9919.999
Mounting plate	3684.074	3684.075	3684.076	3684.077	3684.078	-	-

Other customised solutions regarding dimensions and coloring are available upon request. Please get in contact with one of our sales representatives for further assistance: [Tel. +49 9126 - 29 34 0](tel:+49912629340)

INSTRUMENT CASES AND SYSTEM ENCLOSURES

HeiBox ECO

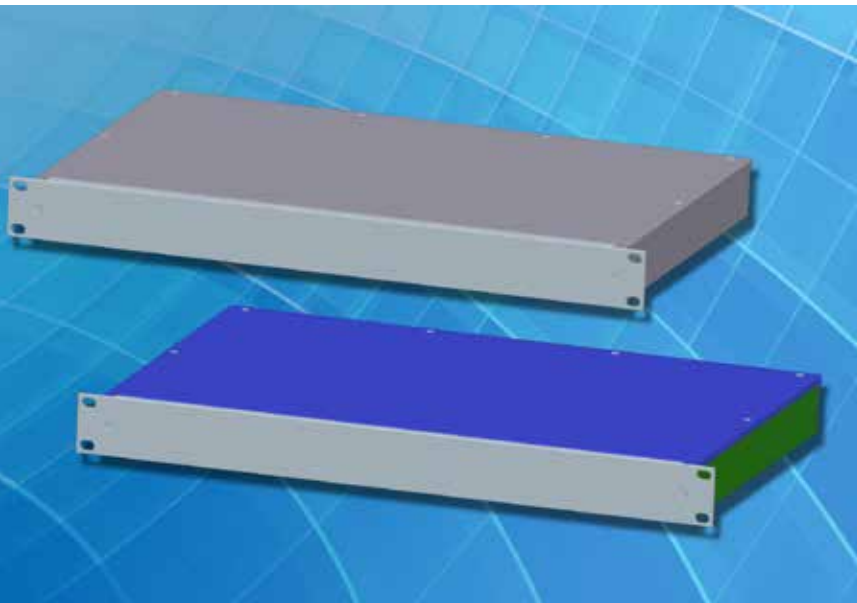

Well-priced system enclosure for standard applications

Applications

The HeiBox ECO is for use as a rack-mount enclosure. Accommodates Eurocards/Double Eurocards (horizontal), bridges, hubs, routers or modems.

Technical specifications

- 19" system enclosure, complies with IEC 60 297-3
- For use as a rack-mount enclosure
- Height: 1 U
- Installation width: 84 HP
- Enclosure made of sheet steel, front panel and rear panel made of extruded aluminium section
- Optionally available as an instrument case or rack-mount enclosure
- Optional: highly effective EMC protection

Benefits at a glance

- Minimum space requirement
- Well-priced and solid
- Easy and fast mounting
- EMC upgradeable
- Individual assembly according to customer needs

NEW

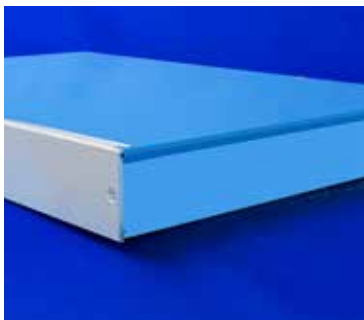

Available as instrument case with individual spray finish upon request

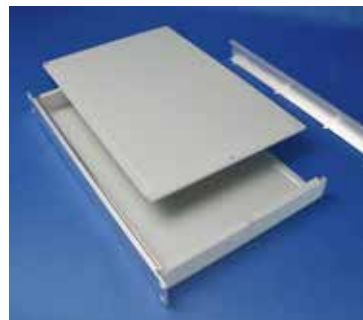

Easy to assemble with just 4 components



High EMC protection with additional EMC kit



Aluminium rear panel easy to process

HeiBox ECO system enclosure 1 U

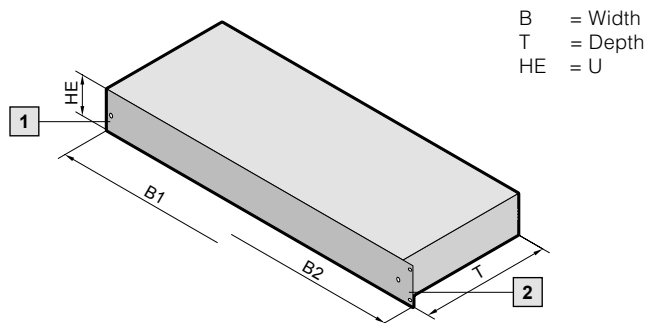
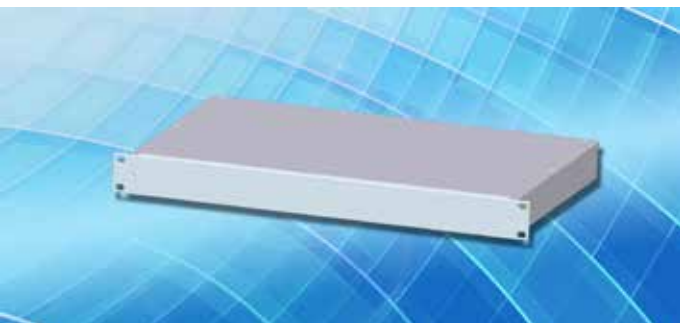

Technical specifications

System enclosures 1 HE, 150, 200, 250, 300, 350 mm deep. Easy to assemble with just 4 components. Optionally for use as an instrument case or 19" rack-mount enclosure. Maximum interior space. Optional EMC upgrades with additional EMC gaskets.

Design

System enclosure 1 U, to IEC 60 297-3. Optionally available for 19" rack-mounting in the enclosure or as an instrument case version on customer request.

- 1** Equipped as an instrument case
- 2** Equipped as a rack-mount unit

Material/surface finish

Base tray: sheet steel
 Front/rear panel: Extruded aluminium section, clear-chromated
 Cover: sheet steel

Note

Upon request, the HeiBox ECO is also available as 2 U version as well as instrument case with individual spray finish.

NEW

U	1	1	1	1	1
Width (B1) mm	447	447	447	447	447
Width (B2) mm	482.6 (19")	482.6 (19")	482.6 (19")	482.6 (19")	482.6 (19")
Depth (T) mm	150	200	250	300	350
Model No. rack-mount unit	9919.795	9919.796	9919.797	9919.798	9919.799
Supply includes					
Cover	1	1	1	1	1
Front panel	1	1	1	1	1
Rear panel	1	1	1	1	1
Base tray	1	1	1	1	1
Accessories					
EMC set	9919.800	9919.800	9919.800	9919.800	9919.800

Other customised solutions regarding dimensions and coloring are available upon request. Please get in contact with one of our sales representatives for further assistance: [Tel. +49 9126 - 29 34 0](tel:+49912629340)

INSTRUMENT CASES AND SYSTEM ENCLOSURES

HeiPac Vario-Module



Modern system enclosure for mobile and stationary applications

Applications

Optionally for use as an instrument case or rack-mount enclosure. Accommodates PCBs or plug-in units. For mobile and stationary applications.

Technical specifications

- 19" system enclosure, complies with IEC 60 297-3
- Optionally for use as an instrument case or rack-mount enclosure
- Basic case optionally with bottom or top cover
- Height: 2 - 7 U
- Installation width: 42, 63, 84 HP
- Depth: 250 - 430 mm
- Variable depth interior installation
- Extruded aluminium section
- Protection category IP 40

Benefits at a glance

- Easy modification from instrument case to rack-mount system
- Broad range of accessories
- Neutral design
- Basic case with variable expansions
- Optional EMC version



Broad range of accessories



Interior fittings from the HeiPac Vario range



Flange for 19" installation



Front corner trims for assembly as instrument case

HeiPac Vario-Module 2 U



B = Width
T = Depth
HE = U
TE = HP

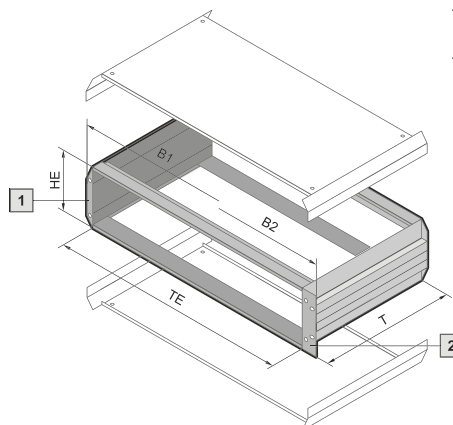

Technical specifications

Optionally for use as an instrument case or rack-mount enclosure. External dimensions to IEC 60 297-3 for installation in enclosures, 482,6 mm (19"). Installation dimensions for plug-in units according to IEC 60 297-3-101.

Protection category

IP 40 for non-vented version.

Supply includes

2 side panels
4 horizontal rails
4 threaded inserts
2 corner trims
Assembly parts

- 1** Equipped as an instrument case
- 2** Equipped as a rack-mount enclosure

Material/surface finish

Side panels: Extruded aluminium section, spray-finished in RAL 7035
Horizontal rail: Extruded aluminium section, clear-chromated
Side trim panels: Extruded aluminium section, spray-finished in RAL 7035

Note

Corner trims, mounting flanges and top/bottom covers have to be ordered separately.

Horizontal rails for additional installations have to be ordered separately, see page 130

Exemplary horizontal rail configuration

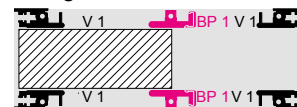

2 U

	Packs of	2 U						Page
Installation width (HP)		42	42	63	63	84	84	
Width (B1) mm		235.6	235.6	342.3	342.3	449.0	449.0	
Width (B2) mm		251.6	251.6	358.3	358.3	465.1	465.1	
Depth (T) mm		250.4	310.4	250.4	310.4	250.4	310.4	
Mod.No. VM basic case	1	3982.000	3982.020	3982.290	3982.300	3982.010	3982.030	
Also required								
Top covers								
- with vent holes	1	3982.941	3982.951	3982.942	3982.952	3982.940	3982.950	107
- without vent holes	1	3982.901	3982.911	3982.902	3982.912	3982.900	3982.910	107
Bottom covers								
- with vent holes	1	3982.741	3982.751	3982.742	3982.752	3982.740	3982.750	107
- without vent holes	1	3982.701	3982.711	3982.702	3982.712	3982.700	3982.710	107
Front corner trims for assembly as instrument case	2	3981.300	3981.300	3981.300	3981.300	3981.300	3981.300	109
Flanges for configuration as rack-mount system - without handle holes	2	3981.200	3981.200	3981.200	3981.200	3981.200	3981.200	108
Accessories								
Front/rear panels	see page 110 - 111							
Rear adjustable feet	4	3901.000	3901.000	3901.000	3901.000	3901.000	3901.000	109

Other customised solutions regarding dimensions and colouring are available upon request. Please get in contact with one of our sales representatives for further assistance: Tel. +49 9126 - 29 34 0

HeiPac Vario-Module

HeiPac Vario-Module 2 U, EMC

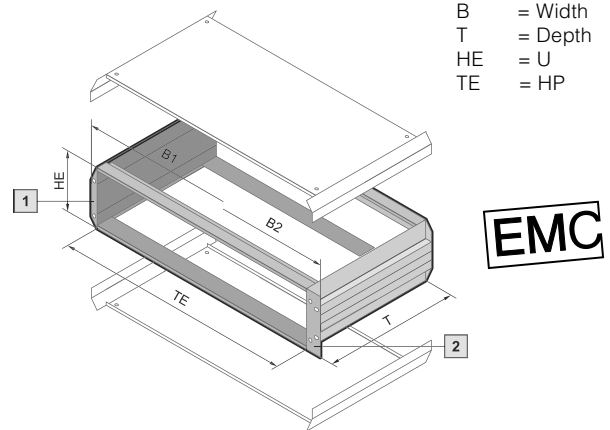

Technical specifications

Optionally for use as an instrument case or rack-mount enclosure. External dimensions according to IEC 60 297-3 for installation in enclosures, 482.6 mm (19"). Installation dimensions for plug-in units according to IEC 60 297-3-101.

Protection category

IP 40 for non-vented version.

Supply includes

- 2 side panels
- 4 horizontal rails
- 4 threaded inserts
- 2 corner trims
- Assembly parts

- 1** Equipped as an instrument case
- 2** Equipped as a rack-mount enclosure

Material/surface finish

- Side panels: Extruded aluminium section, spray-finished in RAL 7035
- Horizontal rail: Extruded aluminium section, clear-chromated
- Corner trims: Extruded aluminium section, spray-finished in RAL 7035
- Contact points: conductive

Note

Corner trims, mounting flanges and top/bottom covers have to be ordered separately.

Horizontal rails for additional installations have to be ordered separately, see pages 130

Exemplary horizontal rail configuration

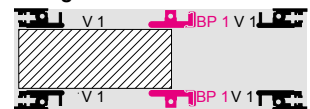

2 U

	Packs of	2 U						Page
Installation width (HP)		42	42	63	63	84	84	
Width (B1) mm		235.6	235.6	342.3	342.3	449.0	449.0	
Width (B2) mm		251.6	251.6	358.3	358.3	465.1	465.1	
Depth (T) mm		250.4	310.4	250.4	310.4	250.4	310.4	
Mod.No. VM basic case EMC	1	3983.000	3983.020	3983.290	3983.300	3983.010	3983.030	
Also required								
Top cover								
- with vent holes	1	3981.941	3981.951	3981.942	3981.952	3981.940	3981.950	107
- without vent holes	1	3981.901	3981.911	3981.902	3981.912	3981.900	3981.910	107
Bottom covers								
- with vent holes	1	3981.741	3981.751	3981.742	3981.752	3981.740	3981.750	107
- without vent holes	1	3981.701	3981.711	3981.702	3981.712	3981.700	3981.710	107
Corner trims for assembly as instrument case	2	3981.300	3981.300	3981.300	3981.300	3981.300	3981.300	109
Flanges for configuration as rack-mount enclosure								
- without handle holes	2	3981.200	3981.200	3981.200	3981.200	3981.200	3981.200	108
EMC installation								
EMC gaskets, horizontal - for upper/lower horizontal rail	1	3684.808	3684.808	3684.808	3684.808	3684.808	3684.808	145
- between covers and horizontal rails	10	3684.245	3684.245	3684.245	3684.245	3684.245	3684.245	147
EMC gaskets, vertical	1	3686.974	3686.974	3686.974	3686.974	3686.974	3686.974	111
Front/rear panels EMC	see page 110 - 111							
Accessories								
Rear adjustable feet	4	3901.000	3901.000	3901.000	3901.000	3901.000	3901.000	109

Other customised solutions regarding dimensions and colouring are available upon request. Please get in contact with one of our sales representatives for further assistance: Tel. +49 9126 - 29 34 0

HeiPac Vario-Module 3 U

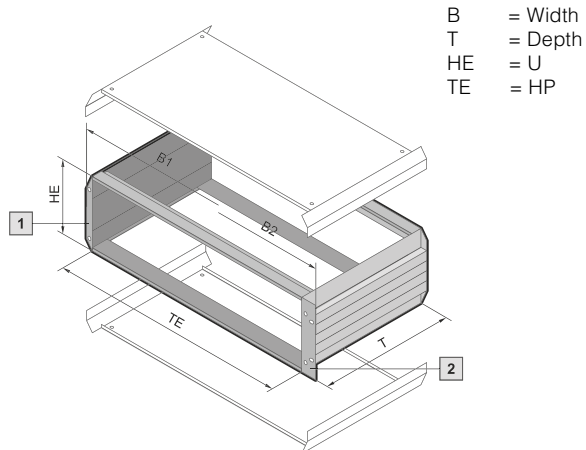

B = Width
T = Depth
HE = U
TE = HP

Technical specifications

Optionally for use as an instrument case or rack-mount enclosure. External dimensions according to IEC 60 297-3 for installation in enclosures, 482.6 mm (19"). Installation dimensions for plug-in units according to IEC 60 297-3-101.

Protection category

IP 40 for non-vented version.

Supply includes

- 2 side panels
- 4 horizontal rails
- 4 threaded inserts
- 2 corner trims
- Assembly parts

- 1** Equipped as an instrument case
- 2** Equipped as a rack-mount enclosure

Material/Surface finish

- Side panels: Extruded aluminium section, spray-finished in RAL 7035
- Horizontal rail: Extruded aluminium section, clear-chromated
- Corner trims: Extruded aluminium section, spray-finished in RAL 7035

Note

Corner trims, mounting flanges and top/bottom covers have to be ordered separately.

Horizontal rails for additional installations have to be ordered separately, see pages 130

Exemplary horizontal rail configuration

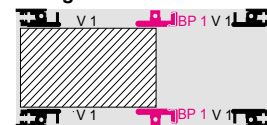

3 U

	Packs of	3 U							Page
Installation width (HP)		42	42	63	63	84	84	84	
Width (B1) mm		235.6	235.6	342.3	342.3	449.0	449.0	449.0	
Width (B2) mm		251.6	251.6	358.3	358.3	465.1	465.1	465.1	
Depth (T) mm		250.4	310.4	250.4	310.4	250.4	310.4	370.4	
Mod.No. VM basic case	1	3982.040	3982.070	3982.050	3982.080	3982.060	3982.090	3982.100	
Also required									
Top covers									
- with vent holes	1	3982.941	3982.951	3982.942	3982.952	3982.940	3982.950	3982.960	107
- without vent holes	1	3982.901	3982.911	3982.902	3982.912	3982.900	3982.910	3982.920	107
Bottom covers									
- with vent holes	1	3982.741	3982.751	3982.742	3982.752	3982.740	3982.750	3982.760	107
- without vent holes	1	3982.701	3982.711	3982.702	3982.712	3982.700	3982.710	3982.720	107
Front corner trims for assembly as instrument case	2	3981.310	3981.310	3981.310	3981.310	3981.310	3981.310	3981.310	109
Flanges for configuration as rack-mount system									
- without handle holes	2	3981.210	3981.210	3981.210	3981.210	3981.210	3981.210	3981.210	108
- with handle holes	2	3981.260	3981.260	3981.260	3981.260	3981.260	3981.260	3981.260	
Accessories									
Front/rear panels	see page 110 - 111								
Carrying handles	2	3981.350	3981.360	3981.350	3981.360	3981.350	3981.360	3981.370	109
Front handles ¹⁾	2	3636.010	3636.010	3636.010	3636.010	3636.010	3636.010	3636.010	57
Rear adjustable feet	4	3901.000	3901.000	3901.000	3901.000	3901.000	3901.000	3901.000	109

¹⁾ Only in conjunction with mounting flanges with handle holes.

Other customised solutions regarding dimensions and colouring are available upon request. Please get in contact with one of our sales representatives for further assistance: Tel. +49 9126 - 29 34 0

HeiPac Vario-Module

HeiPac Vario-Module 3 U, EMC

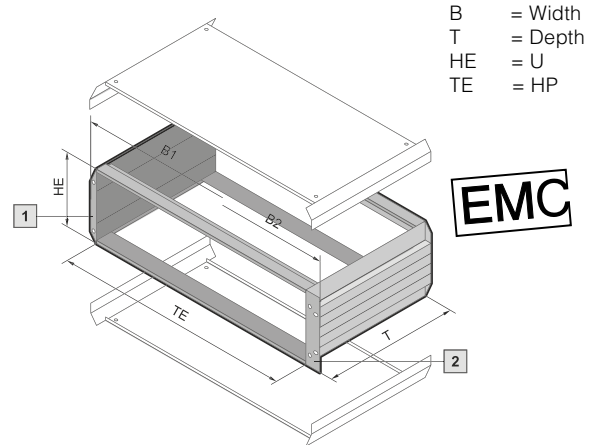

Technical specifications

Optionally for use as an instrument case or rack-mount enclosure. External dimensions according to IEC 60 297-3 for installation in enclosures, 482.6 mm (19"). Installation dimensions for plug-in units according to IEC 60 297-3-101.

Protection category

IP 40 for non-vented version.

Supply includes

- 2 side panels
- 4 horizontal rails
- 4 threaded inserts
- 2 corner trims
- Assembly parts

- 1** Equipped as an instrument case
- 2** Equipped as a rack-mount enclosure

Material/surface finish

- Side panels: Extruded aluminium section, spray-finished in RAL 7035
- Horizontal rail: Extruded aluminium section, clear-chromated
- Corner trims: Extruded aluminium section, spray-finished in RAL 7035
- Contact points: conductive

Note

Corner trims, mounting flanges and top/bottom covers have to be ordered separately.

Horizontal rails for additional installations have to be ordered separately, see pages 130

Exemplary horizontal rail configuration

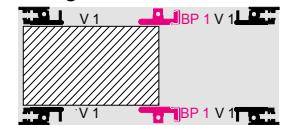

3 U

	Packs of	3 U							Page
		42	42	63	63	84	84	84	
Installation width (HP)									
Width (B1) mm		235.6	235.6	342.3	342.3	449.0	449.0	449.0	
Width (B2) mm		251.6	251.6	358.3	358.3	465.1	465.1	465.1	
Depth (T) mm		250.4	310.4	250.4	310.4	250.4	310.4	370.4	
Mod.No. VM basic case EMC	1	3983.040	3983.070	3983.050	3983.080	3983.060	3983.090	3983.100	
Also required									
Top covers									
- with vent holes	1	3981.941	3981.951	3981.942	3981.952	3981.940	3981.950	3981.960	107
- without vent holes	1	3981.901	3981.911	3981.902	3981.912	3981.900	3981.910	3981.920	107
Bottom covers									
- with vent holes	1	3981.741	3981.751	3981.742	3981.752	3981.740	3981.750	3981.760	107
- without vent holes	1	3981.701	3981.711	3981.702	3981.712	3981.700	3981.710	3981.720	107
Front corner trims for assembly as instrument case	2	3981.310	3981.310	3981.310	3981.310	3981.310	3981.310	3981.310	109
Flanges for configuration as rack-mount system									
- without handle holes	2	3981.210	3981.210	3981.210	3981.210	3981.210	3981.210	3981.210	108
- with handle holes	2	3981.260	3981.260	3981.260	3981.260	3981.260	3981.260	3981.260	
EMC installation									
EMC gaskets, horizontal									
- for upper/lower horizontal rail	1	3684.808	3684.808	3684.808	3684.808	3684.808	3684.808	3684.808	145
- between covers and horizontal rails	10	3684.245	3684.245	3684.245	3684.245	3684.245	3684.245	3684.245	147
EMC gaskets, vertical	1	3686.975	3686.975	3686.975	3686.975	3686.975	3686.975	3686.975	111
Front/rear panels EMC	see page 110 - 111								
Accessories									
Carrying handles	2	3981.350	3981.360	3981.350	3981.360	3981.350	3981.360	3981.370	109
Front handles ¹⁾	2	3636.010	3636.010	3636.010	3636.010	3636.010	3636.010	3636.010	57
Rear adjustable feet	4	3901.000	3901.000	3901.000	3901.000	3901.000	3901.000	3901.000	109

¹⁾ Only in conjunction with mounting flanges with handle holes.

Other customised solutions regarding dimensions and colouring are available upon request. Please get in contact with one of our sales representatives for further assistance: [Tel. +49 9126 - 29 34 0](tel:+49912629340)

INSTRUMENT CASES AND SYSTEM ENCLOSURES

HeiPac Vario-Module

HeiPac Vario-Module 4 U, 6 U, 7 U

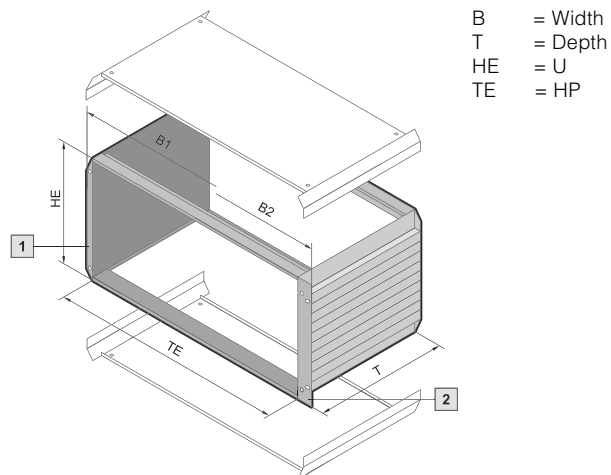

B = Width
T = Depth
HE = U
TE = HP

Technical specifications

Optionally for use as an instrument case or rack-mount enclosure. External dimensions according to IEC 60 297-3 for installation in enclosures, 482.6 mm (19"). Installation dimensions for plug-in units according to IEC 60 297-3-101.

Protection category

IP 40 for non-vented version.

Supply includes

2 side panels
4 horizontal rails
4 threaded inserts
2 corner trims
Assembly parts
2 side trims centre

- 1 Equipped as an instrument case
- 2 Equipped as a rack-mount enclosure

Material/Surface finish

Side panels: Extruded aluminium section, spray-finished in RAL 7035
Horizontal rail: Extruded aluminium section, clear-chromated
Corner trims: Extruded aluminium section, spray-finished in RAL 7035
Side trims centre: Extruded aluminium section, spray-finished in RAL 7035

Note

Corner trims, mounting flanges and top/bottom covers have to be ordered separately.

Exemplary horizontal rail configuration

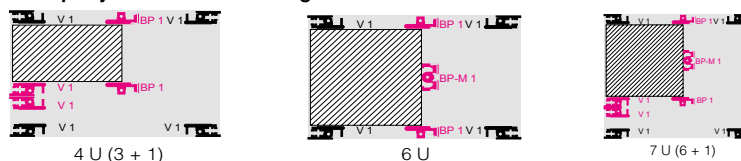

Horizontal rails for additional installations have to be ordered separately, see pages 130

	Packs of	4 U (3 + 1)			6 U			7 U		Page
Installation width (HP)		84	84	84	84	84	84	84	84	
Width (B1) mm		449.0	449.0	449.0	449.0	449.0	449.0	449.0	449.0	
Width (B2) mm		465.1	465.1	465.1	465.1	465.1	465.1	465.1	465.1	
Depth (T) mm		250.4	310.4	370.4	310.4	370.4	430.4	310.4	430.4	
Mod.No. VM basic case	1	3982.110	3982.120	3982.130	3982.140	3982.150	3982.160	3982.170	3982.190	
Also required										
Top covers										
- with vent holes	1	3982.940	3982.950	3982.960	3982.950	3982.960	3982.970	3982.950	3982.970	107
- without vent holes	1	3982.900	3982.910	3982.920	3982.910	3982.920	3982.930	3982.910	3982.930	107
Bottom covers										
- with vent holes	1	3982.740	3982.750	3982.760	3982.750	3982.760	3982.770	3982.750	3982.770	107
- without vent holes	1	3982.700	3982.710	3982.720	3982.710	3982.720	3982.730	3982.710	3982.730	107
Front corner trims for assembly as instrument case	2	3981.320	3981.320	3981.320	3981.330	3981.330	3981.330	3981.340	3981.340	109
Flanges for configuration as rack-mount system										
- without handle holes	2	3981.220	3981.220	3981.220	3981.230	3981.230	3981.230	3981.240	3981.240	108
- with handle holes	2	3981.270	3981.270	3981.270	3981.280	3981.280	3981.280	3981.290	3981.290	108
Accessories										
Front/rear panels	see page 110 - 111									
Carrying handles	2	3981.350	3981.360	3981.370	3981.360	3981.370	3981.380	3981.360	3981.380	109
Front handles ¹⁾	2	3636.010	3636.010	3636.010	3666.010	3666.010	3666.010	3666.010	3666.010	57
Rear adjustable feet	4	3901.000	3901.000	3901.000	3901.000	3901.000	3901.000	3901.000	3901.000	109

¹⁾ Only in conjunction with mounting flanges with handle holes.

Other customised solutions regarding dimensions and colouring are available upon request. Please get in contact with one of our sales representatives for further assistance: Tel. +49 9126 - 29 34 0

INSTRUMENT CASES AND SYSTEM ENCLOSURES

HeiPac Vario-Module

HeiPac Vario-Module 4 U, 6 U, 7 U, EMC

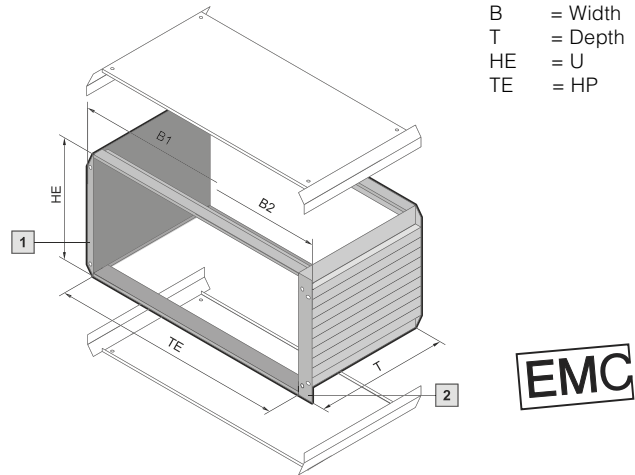

Technical specifications

Optionally for use as an instrument case or rack-mount enclosure. External dimensions according to IEC 60 297-3 for installation in enclosures, 482.6 mm (19"). Installation dimensions for plug-in units according to IEC 60 297-3-101.

Protection category

IP 40 for non-vented version.

Supply includes

2 side panels
4 horizontal rails
4 threaded inserts
2 corner trims
2 side trims centre
Assembly parts

1 Equipped as an instrument case

2 Equipped as a rack-mount enclosure

Material/surface finish

Side panels: Extruded aluminium section, spray-finished in RAL 7035
Horizontal rail: Extruded aluminium section, clear-chromated
Corner trims: Extruded aluminium section, spray-finished in RAL 7035
Side trims centre: Extruded aluminium section, spray-finished in RAL 7035
Contact points: conductive

Note

Corner trims, mounting flanges and top/bottom covers have to be ordered separately.

Horizontal rails for additional installations have to be ordered separately, see page 130

Exemplary horizontal rail configuration see page 105

	Packs of	4 U (3 + 1)			6 U			7 U		Page
Installation width (HP)		84	84	84	84	84	84	84	84	
Width (B1) mm		449,0	449,0	449,0	449,0	449,0	449,0	449,0	449,0	
Width (B2) mm		465,1	465,1	465,1	465,1	465,1	465,1	465,1	465,1	
Depth (T) mm		250,4	310,4	370,4	310,4	370,4	430,4	310,4	430,4	
Mod.No. VM basic case EMC	1	3983.110	3983.120	3983.130	3983.140	3983.150	3983.160	3983.170	3983.190	
Also required										
Top covers										
- with vent holes	1	3981.940	3981.950	3981.960	3981.950	3981.960	3981.970	3981.950	3981.970	107
- without vent holes	1	3981.900	3981.910	3981.920	3981.910	3981.920	3981.930	3981.910	3981.930	107
Bottom covers										
- with vent holes	1	3981.740	3981.750	3981.760	3981.750	3981.760	3981.770	3981.750	3981.770	107
- without vent holes	1	3981.700	3981.710	3981.720	3981.710	3981.720	3981.730	3981.710	3981.730	107
Front corner trims for assembly as instrument case	2	3981.320	3981.320	3981.320	3981.330	3981.330	3981.330	3981.340	3981.340	109
Flanges for configuration as rack-mount system										
- without handle holes	2	3981.220	3981.220	3981.220	3981.230	3981.230	3981.230	3981.240	3981.240	108
- with handle holes	2	3981.270	3981.270	3981.270	3981.280	3981.280	3981.280	3981.290	3981.290	108
EMC installation										
EMC gaskets, horizontal										
- for upper/lower horizontal rail	1	3684.808	3684.808	3684.808	3684.808	3684.808	3684.808	3684.808	3684.808	145
- between covers and horizontal rails	10	3684.245	3684.245	3684.245	3684.245	3684.245	3684.245	3684.245	3684.245	147
EMC gaskets, vertical	1	3686.976	3686.976	3686.976	3686.977	3686.977	3686.977	3686.978	3686.978	111
Front/rear panels EMC	see page 110 - 111									
Accessories										
Carrying handles	2	3981.350	3981.360	3981.370	3981.360	3981.370	3981.380	3981.360	3981.370	109
Front handles ¹⁾	2	3636.010	3636.010	3636.010	3666.010	3666.010	3666.010	3666.010	3666.010	57
Rear adjustable feet	4	3901.000	3901.000	3901.000	3901.000	3901.000	3901.000	3901.000	3901.000	109

¹⁾ Only in conjunction with mounting flanges with handle holes.

Other customised solutions regarding dimensions and colouring are available upon request. Please get in contact with one of our sales representatives for further assistance: Tel. +49 9126 - 29 34 0

INSTRUMENT CASES AND SYSTEM ENCLOSURES

RECOMMENDED ACCESSORIES HeiPac Vario-Module

Top covers

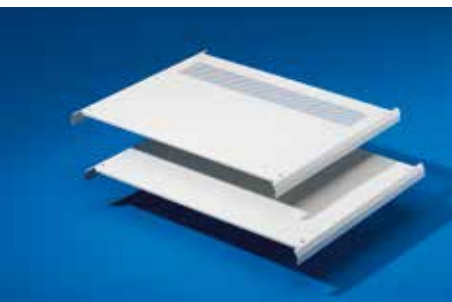

For HeiPac Vario-Module

Standard version - Material

Sheet steel
Spray-finished

Colour

RAL 7035

EMC version - Material

Sheet steel
spray-finished
Contact points: conductive

VM standard

HP	Depth mm	Order No.	
		with vent holes	without vent holes
42	250.4	3982.941	3982.901
	310.4	3982.951	3982.911
63	250.4	3982.942	3982.902
	310.4	3982.952	3982.912
84	250.4	3982.940	3982.900
	310.4	3982.950	3982.910
	370.4	3982.960	3982.920
	430.4	3982.970	3982.930

VM EMC

HP	Depth mm	Order No.	
		with vent holes	without vent holes
42	250.4	3981.941	3981.901
	310.4	3981.951	3981.911
63	250.4	3981.942	3981.902
	310.4	3981.952	3981.912
84	250.4	3981.940	3981.900
	310.4	3981.950	3981.910
	370.4	3981.960	3981.920
	430.4	3981.970	3981.930

Bottom covers



For HeiPac Vario-Module

Standard version - Material

Sheet steel
Spray-finished

Colour

RAL 7035

EMC version - Material

Sheet steel
spray-finished
Contact points: conductive

VM standard

HP	Depth mm	Order No.	
		with vent holes	without vent holes
42	250.4	3982.741	3982.701
	310.4	3982.751	3982.711
63	250.4	3982.742	3982.702
	310.4	3982.752	3982.712
84	250.4	3982.740	3982.700
	310.4	3982.750	3982.710
	370.4	3982.760	3982.720
	430.4	3982.770	3982.730

VM EMC

HP	Depth mm	Order No.	
		with vent holes	without vent holes
42	250.4	3981.741	3981.701
	310.4	3981.751	3981.711
63	250.4	3981.742	3981.702
	310.4	3981.752	3981.712
84	250.4	3981.740	3981.700
	310.4	3981.750	3981.710
	370.4	3981.760	3981.720
	430.4	3981.770	3981.730

INSTRUMENT CASES AND SYSTEM ENCLOSURES

RECOMMENDED ACCESSORIES HeiPac Vario-Module

Feet



With fold-out support stand.
Load capacity up to 20 kg

Material

Plastic

Colour

RAL 7035

Packs of	Order No.
2	3919.000

Mounting plate



For mounting heavy components

Material

Aluminium

Supply includes

Assembly parts

HP	Depth mm	Packs of	Order No.
42	250	1	3982.370
42	310	1	9921.946
42	370	1	9921.947
42	430	1	9921.948
63	250	1	3982.380
63	310	1	9921.949
63	370	1	9921.950
63	430	1	9921.951
84	250	1	3982.390
84	310	1	9921.952
84	370	1	9921.953
84	430	1	9921.954

Front flanges



Required when the HeiPac Vario-Module is to be used as a rack-mount enclosure. The flanges have a channel to accommodate vertical EMC gaskets.

Material

Aluminium

Clear-chromated

U	Packs of	Order No.	
		without handle hole	with handle hole
2	2	3981.200	-
3	2	3981.210	3981.260
4	2	3981.220	3981.270
6	2	3981.230	3981.280
7	2	3981.240	3981.290

+ Accessories

Vertical EMC gasket
see page 146

Front handles for mounting on front flanges,
see page 81

INSTRUMENT CASES AND SYSTEM ENCLOSURES

RECOMMENDED ACCESSORIES HeiPac Vario-Module

Front corner trims



Required when the HeiPac Vario-Module is to be used as an instrument case. The corner trims have a channel to accommodate vertical EMC gaskets.

Material

Aluminium
Spray-finished

Colour

RAL 7035

U	Packs of	Order No.
2	2	3981.300
3	2	3981.310
4	2	3981.320
6	2	3981.330
7	2	3981.340

+ Accessories

Vertical EMC gasket
see page 146

Carrying handles



For ergonomic transportation, even with stacked enclosures. May also be used as a support stand. Max. load capacity: 35 kg.

Material

Die-cast zinc and
Extruded aluminium section

Colour

RAL 7035

Note

Cannot be used with flanges

For enclosure depth mm	Packs of	Order No.
250.4	2	3981.350
310.4	2	3981.360
370.4	2	3981.370
430.4	2	3981.380

Rear feet



For mounting on the rear of the enclosure. Dual function:

- Mechanical protection of the connection components
- Also act as a cable tidy during transportation

Material

PA
Self-extinguishing to UL 94-V0

Colour

RAL 7035

Packs of	Order No.
4	3901.000

INSTRUMENT CASES AND SYSTEM ENCLOSURES

RECOMMENDED ACCESSORIES HeiPac Vario-Module

Earthing set



For connecting the top and bottom covers to the side panels with PE conductors.

Supply includes

Conductor cable green/yellow, 1.5 mm², with washer for screw M4, flat-pin connector

Packs of	Order No.
1	9916.676

Front panels, hinged



Material

2.5 mm Aluminium
Anodised

Supply includes

1 front panel
1 set of hinges
Assembly parts

U	HP	Order No.	
		vertically hinged	horizontally hinged
3	42	3652.600	3652.500
3	84	3652.610	3652.510
6	42	3652.620	3652.520
6	84	3652.630	3652.530

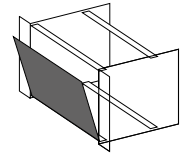

EMC front panels, hinged



Material

2.5 mm Aluminium
Clear-chromated

Supply includes

1 front panel
1 set of hinges
1 contact strip
1 gasket strip
1 vertical EMC gasket, version 1
Assembly parts

U	HP	Order No.
		horizontally hinged
3	84	3684.298
4	84	3684.299
6	84	3684.300
7	84	3684.301

EMC

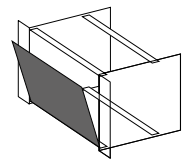

Front panels as filler panel



Flat

Material

2.5 mm Aluminium,
Natural-anodised

HP	Order No.				
	2 U H = 84.25	3 U H = 128.7	4 U H = 173.15	6 U H = 262.05	7 U H = 306.5
42	3684.887	3684.904	3684.908	3684.925	3684.928
63	-	3684.906	3684.909	3684.926	3684.929
84	3684.888	3684.907	3684.910	3684.927	3684.930

+ Also required

Collar screws and plastic collars, packs of 100 sets, order No. 3658.160 see page 202

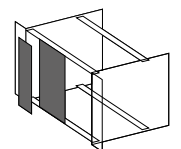

INSTRUMENT CASES AND SYSTEM ENCLOSURES RECOMMENDED ACCESSORIES HeiPac Vario-Module

EMC front panels as filler panels

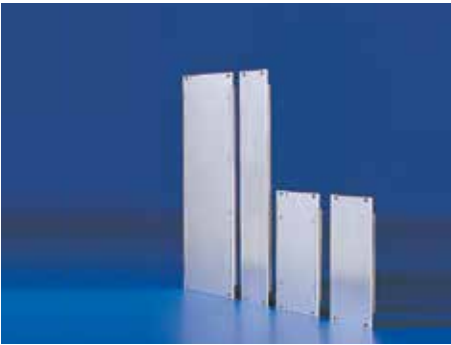

U-shaped

Material

2.5 mm extruded aluminium section,
Clear-chromated

Supply includes

1 front panel, one-piece
(with 2 – 14 HP version)
or three-piece
(with > 14 HP version),
1 vertical EMC gasket, version 1
1 contact strip (three-piece only)
1 gasket strip (three-piece only)

HP	Order No.				
	2 U H = 84.25	3 U H = 128.7	4 U H = 173.15	6 U H = 262.05	7 U H = 306.5
42	-	3684.252	3684.255	3684.261	3684.264
63	-	3684.253	3684.256	3684.262	3684.265
84	3684.248	3684.254	3684.257	3684.263	3684.266

+ Also required

Slotted centering screws
packs of 100, order no. 3687.050
see page 203
Cross-head centering screws
packs of 100, order no. 3687.051
see page 203

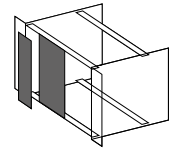

Support stand/carrying handle



To fit HeiPac Vario Module 3 U, 4 U and 6 U,
adjustable on a 30° pitch pattern.

Material

Extruded aluminium section/die-cast

Colour

RAL 7035

Supply includes

Assembly parts

Note

Corner trim for support stands/carrying
handles should be ordered separately.

For HeiPac Vario-Module HP	Packs of	Order No.
42	1	3981.390
63	1	3981.400
84	1	3981.410

Corner trim for support stand U	Packs of	Order No.
3	2	3981.310
4	2	3981.500
6	2	3981.330

EMC gaskets, vertical



To ensure EMC protection between the
subracks side panel and the front/rear
panels.
There are two versions available.

Suitable for mounting on:

- 482,6 mm (19") flanges for subracks
- Corner trims, rear
- EMC contact strip
- U-channel front panels

Material

Stainless steel

German patent
No. 101 15 525 and
No. 198 46 627
US patent no. 6,500,012
US patent no. 7,044,753



Version 1: Segmented

U	Order No. Packs of 1	Order No. Packs of 10
1	3686.973	3684.236
2	3686.974	3684.237
3	3686.975	3684.238
4	3686.976	3684.239
6	3686.977	3684.240
7	3686.978	3684.241
9	3686.979	3684.242
10	3686.980	3684.243
11	3686.981	3684.244

Version 2: One-piece

U	Order No. Packs of 1	Order No. Packs of 10
2	3688.610	-
3	3688.611	9921.942
4	3688.612	-
5	3688.613	-
6	3688.614	9921.943
7	3688.615	-
8	3688.634	-
9	3688.616	9921.944
10	3688.609	-
11	3688.633	-
12	3688.606	-

INSTRUMENT CASES AND SYSTEM ENCLOSURES

HeiCase



Universal instrument case in a timeless design

Applications

The HeiCase is the HEITEC instrument case of sophisticated design that is suitable for 19" rack-mount systems as well as individual configuration. In combination with rollers and carrying handles the instrument case is particularly easy to transport.

Technical specifications

- Instrument case, complies with IEC 60 297-3
- Height: 1 – 12 HE
- Installation with: ½ 19" und 19"
- Depth: 300 – 540 mm
- Protection category IP 42
- Extruded aluminium section
- Variable depth/height interior installation

Benefits at a glance

- Outstanding stability
- Upgradeable to a tower version
- Standard in 3 colours
- Ergonomic handles, bottom- and door types
- For mobile and stationary applications



Flexible sizing through modular design



Stable set up from aluminium profiles



Wide range of accessories

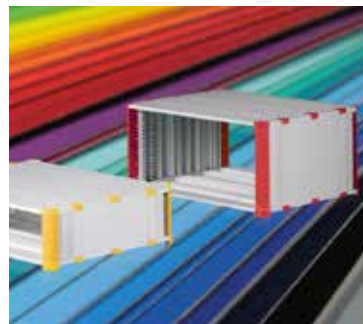

Individual colouring

High flexibility following customer requests



The modular line of standard casings can be manufactured to a height of up to 30 U and a depth of up to 900 mm.

Those maxi-versions are suitable for applications of high packing density as well as a mobile alternative to cabinets. Thanks to their set up of individual, interconnected extruded aluminium sections even the large versions provide a high degree of stability and are scalable not only in height, but also in depth (up to 900mm), modular in segments of 120mm.

If necessary, they can be mounted on rollers for mobile applications and can be equipped with specific handles, thus providing mobility and making the enclosure flexibly applicable despite its large dimensions. The carrying handles were tested to a load of 100kg and are suitable for heavy load applications.

The design of the enclosure can be customised to match the customer's corporate design. Decorative elements (corner trims and plastic parts) and even the system enclosure of the maxi versions can be designed in your desired RAL-color if required.

Due to their solid structure the customised versions meet the requirements for robust instrument case and system enclosures with scalable interior and exterior installations. Through a variety of accessories they can be adapted to the respective requirements.

HeiCase 1/2 19"

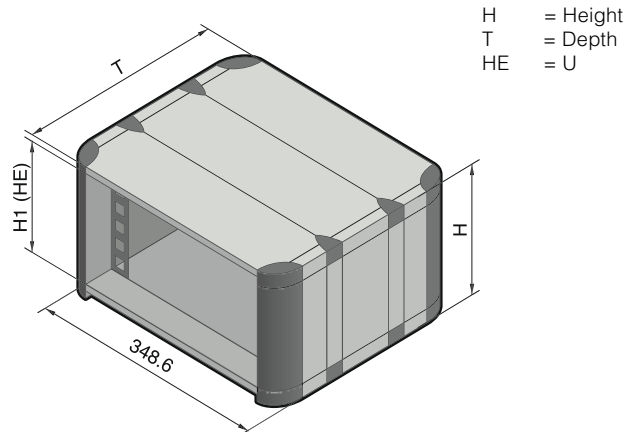

Technical specifications

Depth: 300 mm, 420mm, 540 mm
 Installation width: 269,2 mm (1/2 19")
 Installation options: 269,2 mm (1/2 19")-slide-in equipment to 60 297-3

Protection category

IP 42 for unvented version

Supply includes

- 2 side panels
 - 2 covers
 - 8 corner caps
 - 8/12/16 cover caps (300/420/540 mm depth)
 - 4 19" mounting brackets
 - 4 threaded inserts
 - 2 plain inserts,
 - 1 rear panel
- Cases are supplied preassembled

Colour

RAL 7035 (pale grey)

Decorative colours and corner caps

- RAL 5018 (turquoise)
- RAL 5012 (pale blue)
- RAL 7030 (stone grey)

Material/surface finish

- Covers: Extruded aluminium section/die-cast, spray-finished
- Side panels: Extruded aluminium section, spray-finished
- Corner caps: Plastic
- (19") mounting bracket: Extruded aluminium section, clear-chromated

Property rights

- German registered design no. 96 09 457
- UK reg. design no. 2064682
- US design patents
- Des. 402,640 and Des. 423,464
- Japan. reg. designs no. 1045507 and 1045508

Enclosures for subrack width 269,2 mm (1/2 19")	Packs of	1 U		2 U		3 U			4 U		Page
Height (H) mm		77.5	77.5	121.9	121.9	166.4	166.4	166.4	210.8	210.8	
H1 mm		45.0	45.0	89.4	89.4	133.8	133.8	133.8	178.3	178.3	
Depth (T) mm		300.0	420.0	300.0	540.0	300.0	420.0	540.0	420.0	540.0	
Unvented											
Order No. RAL 5018	1	3750.100	-	3750.200	-	3750.210	3750.300	-	3750.400	-	
Order No. RAL 5012	1	3750.102	-	3750.202	-	3750.212	3750.302	-	3750.402	-	
Order No. RAL 7030	1	3750.104	-	3750.204	-	3750.214	3750.304	-	3750.404	-	
Vented											
Order No. RAL 5018	1	-	3750.110	-	3750.220	-	3750.350	3750.360	-	3750.450	
Order No. RAL 5012	1	-	3750.112	-	3750.222	-	3750.352	3750.362	-	3750.452	
Order No. RAL 7030	1	-	3750.114	-	3750.224	-	3750.354	3750.364	-	3750.454	
Weight (kg)	vented/		3.3	4.2	3.7	5.4	4.1	5.2	6.1	5.8	6.8
	unvented		3.4	4.4	3.8	6.1	4.2	5.4	6.8	6.0	7.5
Accessories											
Support stand/carrying handle	1	see page 120									
Carrying handles, horizontal	2	3751.250	3751.260	3751.250	3751.270	3751.250	3751.260	3751.270	3751.260	3751.270	118
Back panel screw-fastened	1	-	-	-	-	9918.119	9918.119	9918.119	9918.120	9918.120	121
Front door, vertically hinged	1	-	-	-	-	3751.300	3751.300	3751.300	3751.310	3751.310	119
Slide rails	2	3751.500	3751.510	3751.500	3751.520	3751.500	3751.510	3751.520	3751.510	3751.520	116
Mounting angles 19°	2	3751.650	3751.650	3751.660	3751.660	3751.670	3751.670	3751.670	3751.680	3751.680	116
Threaded inserts with M4 thread	8	3751.700	3751.700	3751.710	3751.710	3751.720	3751.720	3751.720	3751.730	3751.730	116
End section	4	-	-	-	-	3751.900	3751.900	3751.900	3751.910	3751.910	118

Other customised solutions regarding dimensions (up to 30 U height and up to 900 mm depth) and colouring are available upon request. Please get in contact with one of our sales representatives for further assistance: Tel. +49 9126 - 29 34 0

HeiCase 19"

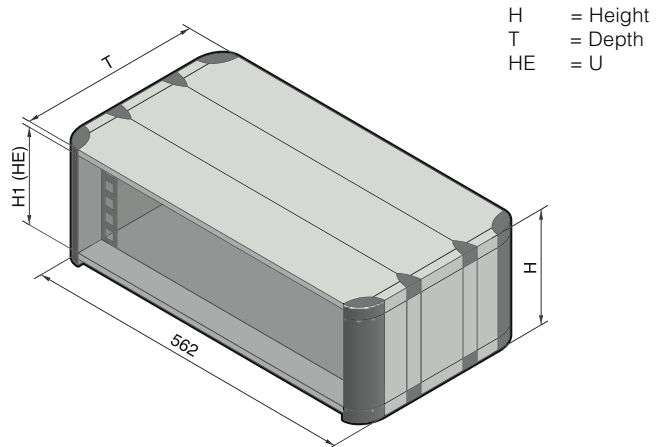
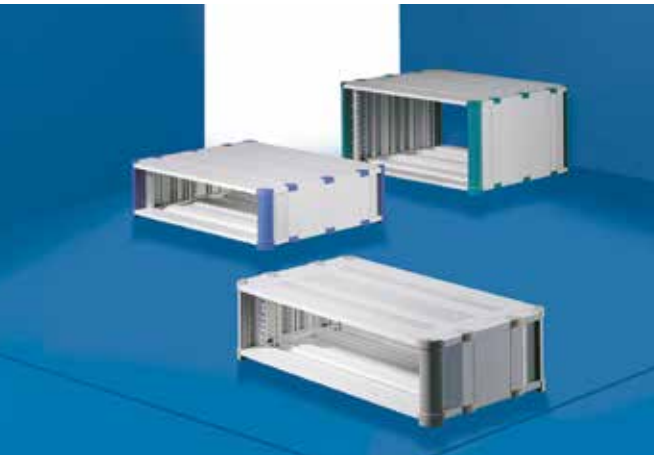

H = Height
T = Depth
HE = U

Technical specifications

Depth: 300 mm, 420mm, 540 mm
Installation width: 482,6 mm (19")
Installation options: 482,6 mm (19")-slide-in equipment to IEC 60 297-3

Protection category

IP 42 for unvented version

Supply includes

2 side panels
2 covers
8 corner caps
8/12/16 cover caps
(300/420/540 mm depth)
4 19" mounting brackets
4 threaded inserts
2 plain inserts
Cases are supplied preassembled

Note

For rear installation, order back panel/door separately.

Colour

RAL 7035 (pale grey)

Decorative colours and corner caps

RAL 5018 (turquoise)
RAL 5012 (pale blue)
RAL 7030 (stone grey)

Material/surface finish

Covers: Extruded aluminium section/die-cast, spray-finished
Side panels: Extruded aluminium section, spray-finished
Corner caps: Plastic
(19") mounting bracket: Extruded aluminium section, clear-chromated

Property rights

German registered design no. 96 09 457
UK reg. design no. 2064682
US design patents
Des. 402,640 and Des. 423,464
Japan. reg. designs no. 1045507 and 1045508

Enclosures for subrack width 19"	Packs of	3 U		4 U		6 U			7 U		9 U		12 U	Page
Height (H) mm		166.4	166.4	210.8	210.8	299.7	299.7	299.7	344.2	344.2	433.1	433.1	566.5	
H1 mm		133.8	133.8	178.3	178.3	267.2	267.2	267.2	311.7	311.7	400.6	400.6	534.0	
Depth (T) mm		300.0	420.0	300.0	420.0	300.0	420.0	540.0	420.0	540.0	420.0	540.0	540.0	
Unvented														
Order No. RAL 5018	1	3750.310	3750.320	3750.410	3750.420	3750.600	3750.610	3750.620	3750.700	3750.710	3750.900	3750.910	3750.000	
Order No. RAL 5012	1	3750.312	3750.322	3750.412	3750.422	3750.602	3750.612	3750.622	3750.702	3750.712	3750.902	3750.912	3750.002	
Order No. RAL 7030	1	3750.314	3750.324	3750.414	3750.424	3750.604	3750.614	3750.624	3750.704	3750.714	3750.904	3750.914	3750.004	
Vented														
Order No. RAL 5018	1	3750.330	3750.340	3750.430	3750.440	3750.630	3750.640	3750.650	3750.720	3750.730	3750.920	3750.930	3750.030	
Order No. RAL 5012	1	3750.332	3750.342	3750.432	3750.442	3750.632	3750.642	3750.652	3750.722	3750.732	3750.922	3750.932	3750.032	
Order No. RAL 7030	1	3750.334	3750.344	3750.434	3750.444	3750.634	3750.644	3750.654	3750.724	3750.734	3750.924	3750.934	3750.034	
Weight (kg)	vented/ unvented	5.3 5.4	6.9 7.1	5.7 7.2	7.5 7.7	6.5 6.6	8.5 8.7	10.8 12.2	9.1 9.3	11.5 12.9	10.1 10.3	12.9 14.3	15.0 16.4	
Accessories														
Support stand/carrying handle	1	see page 120												
Carrying handles, horizontal	2	3751.250	3751.260	3751.250	3751.260	3751.250	3751.260	3751.270	3751.260	3751.270	3751.260	3751.270	3751.270	118
Back panel screw-fastened	1	3751.600	3751.600	3751.610	3751.610	3751.620	3751.620	3751.620	3751.630	3751.630	3751.530	3751.530	3751.540	121
Rear door, vertically hinged	1	3751.100	3751.100	3751.110	3751.110	3751.120	3751.120	3751.120	3751.130	3751.130	-	-	-	121
Rear door for fan installation	1	3751.150	3751.150	3751.160	3751.160	3751.170	3751.170	3751.170	3751.180	3751.180	-	-	-	121
Front door, vertically hinged	1	3751.320	3751.320	3751.330	3751.330	3751.340	3751.340	3751.340	3751.350	3751.350	-	-	-	119
Slide rails	2	3751.500	3751.510	3751.500	3751.510	3751.500	3751.510	3751.520	3751.510	3751.520	3751.510	3751.510	3751.520	116
Mounting angles 19"	2	3751.670	3751.670	3751.680	3751.680	3751.690	3751.690	3751.690	3751.640	3751.640	3751.780	3751.780	3751.790	116
Threaded inserts with M4 thread	8	3751.720	3751.720	3751.730	3751.730	3751.740	3751.740	3751.740	3751.750	3751.750	3751.760	3751.760	3751.770	116
End section	2	3751.900	3751.900	3751.910	3751.910	3751.920	3751.920	3751.920	3751.930	3751.930	3751.820	3751.820	3751.830	118

Other customised solutions regarding dimensions (up to 30 U height and up to 900 mm depth) and colouring are available upon request. Please get in contact with one of our sales representatives for further assistance: [Tel. +49 9126 - 29 34 0](tel:+49912629340)

Accessories and services for HeiCase

In addition to the presented subrack-kits, we offer components for your individual configuration on the following pages

WE MEET YOUR INDIVIDUAL NEEDS!

You are looking for a product in the field of electronic packaging that is not in our catalogue? Please contact us! Due to our extensive range of services we can meet all your demands.

We will gladly submit a tailored quotation.

Phone: 09126 - 29 34 0

E-Mail: eps-quote@heitec.de

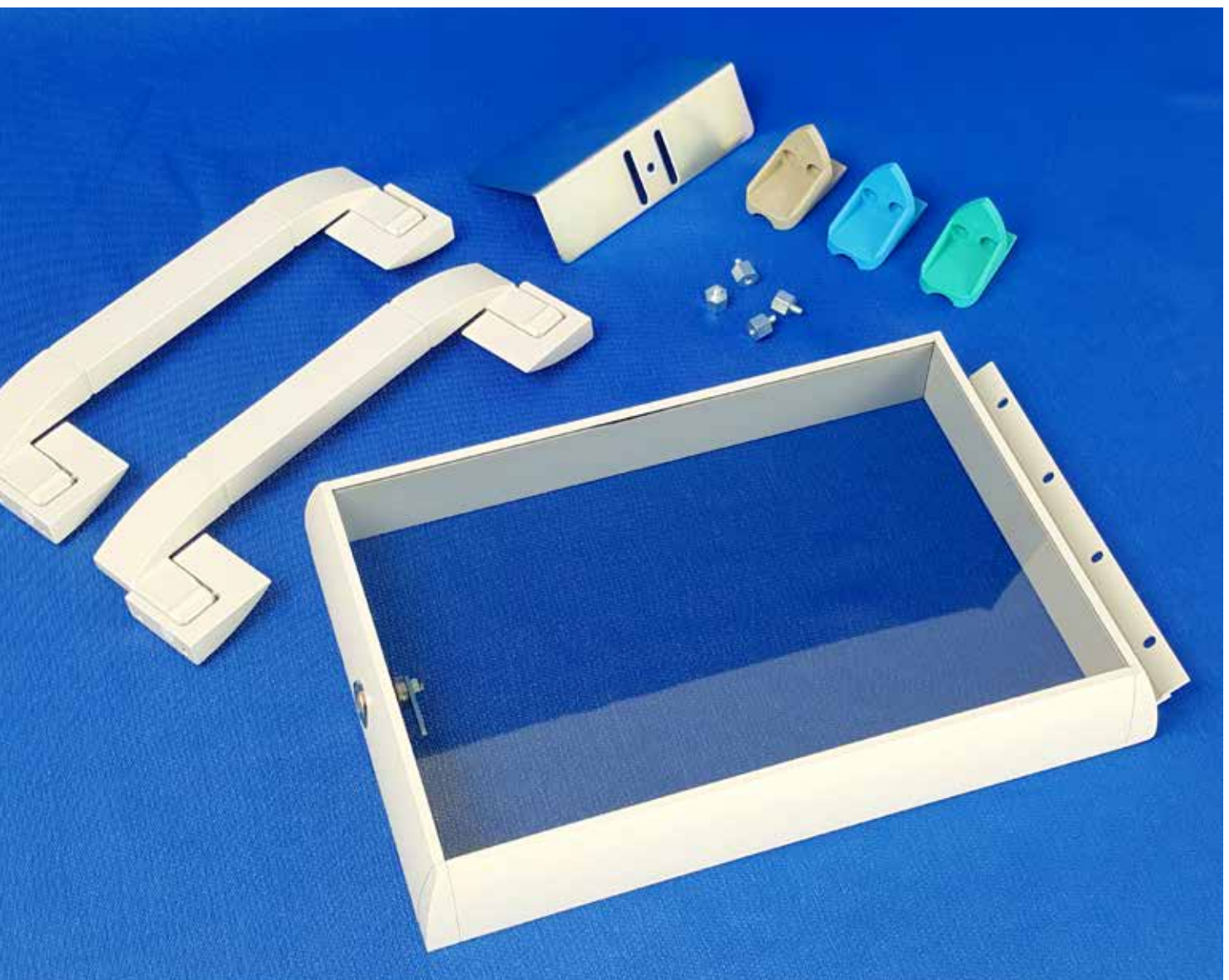

INSTRUMENT CASES AND SYSTEM ENCLOSURES

RECOMMENDED ACCESSORIES HeiCase

Mounting angles for 482,6 mm (19")



For front installation of subracks and blanking plates.

Material

Extruded aluminium section
Clear-chromated

Supply includes

Assembly parts

Note

1 pack of threaded inserts and 2 packs of mounting rails and spacers are required for depth-adjustable installation.

For enclosure height U	Packs of	Order No.
1	2	3751.650
2	2	3751.660
3	2	3751.670
4	2	3751.680
6	2	3751.690
7	2	3751.640
9	2	3751.780
12	2	3751.790

+ Also required

Threaded inserts, see page 116
Mounting rails, see page 117
Spacers, see page 117

Threaded inserts



With M4 thread for HeiCase

For the installation of mounting angles, slide rails, mounting kits, cable ducts etc. Simply slide into the channels in the side panels.

Material

Extruded aluminium section
Clear-chromated

For enclosure height U	Packs of	Order No.
1	8	3751.700
2	8	3751.710
3	8	3751.720
4	8	3751.730
6	8	3751.740
7	8	3751.750
9	8	3751.760
12	8	3751.770

Slide rails



To support heavy installed equipment.

Material

1,5 mm sheet steel,
Clear-chromated

Supply includes

Assembly parts

For enclosure depth mm	Packs of	Order No.
300	2	3751.500
420	2	3751.510
540	2	3751.520
660	2	9919.472

+ Also required

Threaded inserts, see page 116

Mounting rails



- For depth-variable installation of mounting angles
- For the installation of component shelves, static or pull-out

Material

Aluminium
Clear-chromated

Supply includes

Assembly parts

A Version for depth-variable mounting angles

1 Threaded inserts

2 Short spacers

3 Mounting rails

For enclosure depth mm	Packs of	Order No.
300	2	3751.400
420	2	3751.410
540	2	3751.420

+ Also required

Threaded inserts, see page 116
Spacers, see page 117

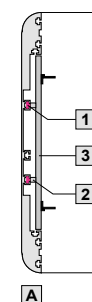

Spacers

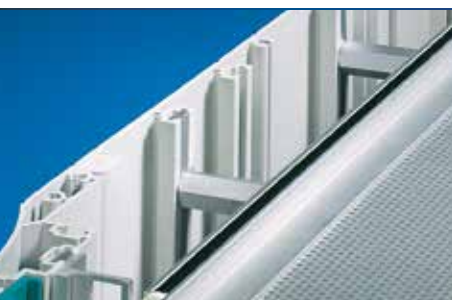

For the attachment of mounting rails.

Design	Packs of	Order No.
Short for depth-variable mounting bracket	4	3751.450
long for mounting plate installation (width 409 mm)	4	3751.460

INSTRUMENT CASES AND SYSTEM ENCLOSURES

RECOMMENDED ACCESSORIES HeiCase

Earthing set



To meet electrical protective measures; fits all HeiCase enclosures.

Supply includes

Threaded insert, screw, green/yellow connection cable, serrated washer, nut

Packs of	Order No.
4	3798.000

Rear trim



To cover the sides to the left and right of the subrack when no rear door or rear panel is used.

Material

Extruded aluminium section
Spray-finished

Colour

RAL 7035

Supply includes

Assembly parts

For enclosure height U	Packs of	Order No.
3	2	3751.900
4	2	3751.910
6	2	3751.920
7	2	3751.930
9	2	3751.820
12	2	3751.830

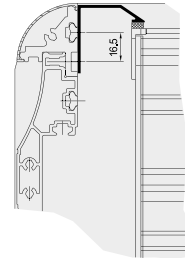

Carrying handles



Horizontal

For easy, secure transportation.

- May be retrofitted
- Load capacity 100 kg

Material

Side parts: Die-cast, spray-finished
Centre part: Extruded aluminium section
spray-finished

Colour

RAL 7035

Supply includes

Assembly parts

For enclosure depth mm	Packs of	Order No.
300	2	3751.250
420	2	3751.260
540	2	3751.270

INSTRUMENT CASES AND SYSTEM ENCLOSURES

RECOMMENDED ACCESSORIES HeiCase

Keyboard lid



Suitable for the installation of 19" keyboards

- Horizontally hinged with security lock
- Removable cover plate

Material

Frame section: Extruded aluminium section/
die-cast, spray-finished
Base and cover plate: Aluminium, spray-
finished

Colour

RAL 7035

Supply includes

Assembly parts

For enclosure width	Height (H) U	Packs of	Order No.
19"	4	1	3751.800
19"	6	1	3751.810

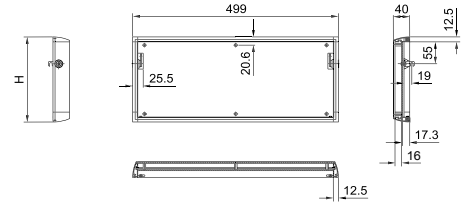

Front door with smoked acrylic, vertically hinged



For mechanical protection of built-in control components.

- Optionally hinged on the right or left
- With security lock

Material

Frame section: Extruded aluminium section,
Spray-finished
Corner pieces: Die-cast aluminium,
Spray-finished
Glazed pane: Smoked acrylic

Colour

RAL 7035

Supply includes

Assembly parts

Note

The figure shows the 6 U version; solutions smaller than 6 U feature a front door with only one security lock.

For enclosure width	W mm	Height (H) U	Order No.
½ 19"	289	3	3751.300
½ 19"	289	4	3751.310
19"	503	3	3751.320
19"	503	4	3751.330
19"	503	6	3751.340
19"	503	7	3751.350

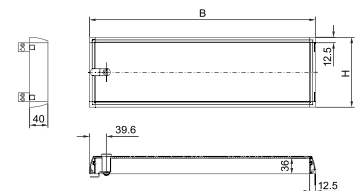

INSTRUMENT CASES AND SYSTEM ENCLOSURES

RECOMMENDED ACCESSORIES HeiCase

Aluminium front door, vertically hinged



For mechanical protection of built-in control components.

- Optionally hinged on the right or left
- With security lock

Material

Frame section: Extruded aluminium section, spray-finished
 Corner pieces: Die-cast aluminium, spray-finished
 Aluminium plate

Colour

RAL 7035

Supply includes

Assembly parts

Note

The figure shows the 6 U version; solutions smaller than 6 U feature a front door with only one security lock.

For enclosure width	W mm	Height (H) U	Order No.
19"	503	3	3751.360
19"	503	4	3751.370
19"	503	6	3751.380

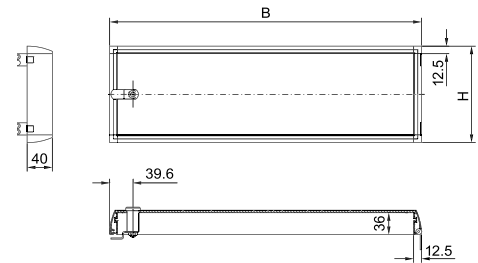

Tower feet

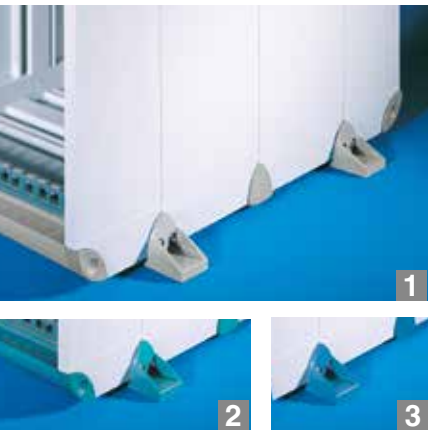

For vertical siting of enclosures.
 May be retrofitted.

Material

Plastic to UL 94-V0,
 Self-extinguishing

Decorative colours

- 1 RAL 7030 (stone grey)
- 2 RAL 5018 (turquoise)
- 3 RAL 5012 (pale blue)

Supply includes

4 tower feet
 Assembly parts

Decorative colour RAL	Packs of	Order No.
5018	1 set	3751.850
5012	1 set	3751.852
7030	1 set	3751.854

Support stand/carrying handles



- Support stand/carrying handle adjustable in 30° increments
- Suitable for retro-fitting to 2 – 7 U
- For ½ 19" and 19" enclosures
- Load capacity 30 kg

Material

Hinged part: Die-cast, spray finished in RAL 7035,
 Centre part: Extruded aluminium section, spray finished in RAL 7035 with plastic coating

Decorative colour

- 1 RAL 7030 (stone grey)
- 2 RAL 5018 (turquoise)
- 3 RAL 5012 (pale blue)

Supply includes

1 support stand/carrying handle
 Assembly parts

For enclosure width	W mm	Colour RAL	Order No.
½ 19"	392	5018	3751.200
½ 19"	392	5012	3751.202
½ 19"	392	7030	3751.204
19"	605	5018	3751.210
19"	605	5012	3751.212
19"	605	7030	3751.214

W = total width handle
 PU = 1 set

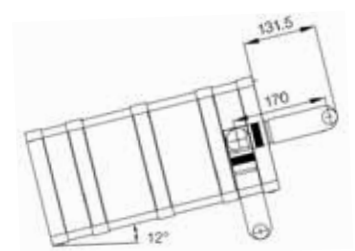

NEW

INSTRUMENT CASES AND SYSTEM ENCLOSURES

RECOMMENDED ACCESSORIES HeiCase

Back panel, screw-fastened



To close off the rear.

Material

Aluminium, 2 mm,
Natural-anodised

Supply includes

2 19" mounting brackets
Assembly parts

Height(H) U	Packs of	Order No.	
		enclosure width L = 1/2 19"	enclosure width L = 19"
3	1	9918.119	3751.600
4	1	9918.120	3751.610
6	1	9918.121	3751.620
7	1	9918.122	3751.630
9	1	9918.123	3751.530
12	1	9918.125	3751.540

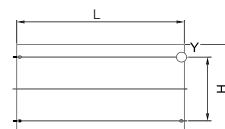

Rear door, vertically hinged



To close off the rear.

- Hinged, with security lock
- Optionally hinged on the left or right

Material

Aluminium, 2,5 mm
Spray-finished

Colour

RAL 7035

Supply includes

Assembly parts

For enclosure width	Height (H) U	Packs of	Order No.
19"	3	1	3751.100
19"	4	1	3751.110
19"	6	1	3751.120
19"	7	1	3751.130

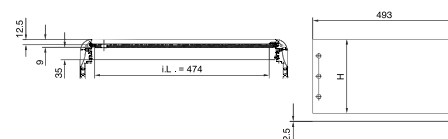

Rear door for fan installation



To close off the rear.

- With security lock
- For the installation of 120 mm fans
- Optionally hinged on the left or right
- For the installation of two fans

Material

Aluminium, 2,5 mm
Spray-finished

Colour

RAL 7035

Supply includes

Assembly parts

For enclosure width	Height (H) U	H1 mm	Order No.
19"	3	66.65	3751.150
19"	4	88.90	3751.160
19"	6	83.50	3751.170
19"	7	83.50	3751.180

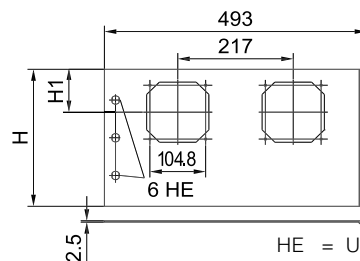

INSTRUMENT CASES AND SYSTEM ENCLOSURES

APPLICATION EXAMPLE

Transportation



Flexible bench chassis for function testing systems in automotive industry

Compact and flexible system chassis are playing an increasingly important role in the automotive industry as a substitute for control cabinets. A HEITEC customer had this exact requirement for a car seat function testing system. In this case, it was essential to be able to fit the system without difficulty below the conveyor belts transporting the car seats.

Considering its dimensions, a standard control cabinet would have been out of the question for this application. The HEITEC HeiCase is an ideal substitute in such situations. Thanks to its flexible assembly options, made possible by the use of aluminum extruded cross-sections, the HeiCase can be precisely adapted to actual spatial conditions on-site. That makes it much more flexible than a standard control cabinet, and just as sturdy.

In addition, the system also had to be easy to transport, despite the many built-in items that add considerable weight. This was solved by using flexible transport rollers with a locking brake, which made it possible to transport the unit without difficulty even on uneven surfaces.

Besides producing the casing in the customer's corporate design colours, HEITEC also had to ensure sufficient protection against environmental contaminants such as dust, and so the HeiCase was supplied in protection class IP52.

The chassis also had to be easily protected against unauthorised access – but the customer did not want a normal key for the system. All of the chassis had to be lockable using the same tool. That would prevent the risk of mixing up keys and minimize the chance of losing them. The solution was a tool-based four-sided warded lock that provides a simple, yet effective locking option.



Technical Summary

- Customer-specific system chassis
- Transport rollers with locking brake
- L x W x H: 660 mm x 19" x 7U
- Design elements in RAL 5017
- Tool-based locking options (4-sided warded lock)

Customer Benefits

- Appealing, timeless exterior to suit corporate design requirements
- High level of protection against environmental influences such as dust
- Transport rollers with locking brake ensure easy transportation of the system chassis even with multiple built-in elements
- Small form factor saves space, enabling the unit to be installed even in compact locations
- Locking technology easy to use
- Cost-optimised chassis concept

Industrial control

Mobile data collection in an industrial environment

Mobile, Internet-supported data collection and the corresponding communications tools are now essential elements in the manufacturing processes of many industrial firms. That's why HEITEC developed a system solution for one of its customers that enabled it to gather complex measurement data for its in-house liquid filter system manufacturing processes.

High standards were set for both the electronics and the mechanical aspects. First, the system had to function reliably even when exposed to major temperature fluctuations and strong impacts and vibrations. It also had to be unaffected by splashing water, dust or grease. Maintenance had to be as simple as possible, with due consideration for the technical requirements.

The entire complex system was integrated into a HeiPac Vario-Modul measuring 310 mm x 42HP x 4U (L x W x H), a standard element in HEITEC's portfolio. The HeiPac Vario-Modul is cost-effective, with an excellent compact, stable, full-metal casing that proved to be ideally suited for this application. In accordance with customer specifications, the front and side panels were produced in the customer's corporate design and the side panels given new colours – no further adjustments to the standard product were needed. The front plate contains the connections for the four different measuring modules that are supplied internally with a voltage of 24V. The back contains a switchable combination module for power input and a covered, grounded socket to supply power to a laptop. There is also a USB port and an attachment for an external power supply for a laptop. A grounding terminal on the back also enables the entire system to be fully grounded.

The use of fans was avoided to protect the electronics, with their complicated wiring, against harmful external influences. To ensure proper heat regulation with high electromagnetic compatibility, the components were appropriately spaced on a full aluminum mounting plate to guarantee passive heat dissipation for the system. Standardised solutions were used for the hardware and software components where possible, to keep the cost of the entire system as low as possible.

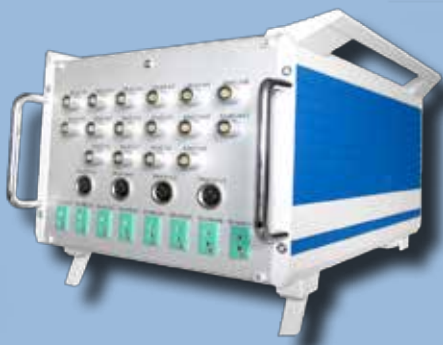

Technical Summary

- Customer-specific system solution
- Standard HEITEC chassis with colours adapted to suit customer's corporate design (RAL5005)
- Internal power management (24V) for measurement components
- L x W x H: 310 mm x 42HP x 4U
- Power supply: 230V mains voltage
- Highly effective EMC protection
- Stable, compact, full-metal casing with integrated mounting plate (side panels and transverse sections made of aluminum extruded cross-section and corner frames of sturdy die-cast zinc)

Customer Benefits

- Plug & Play system solution
- Powerful system makes it easy to handle large data volumes
- Good tightness to protect against harmful external influences, such as dust and dirt
- High shock and vibration resistance
- Good accessibility despite elaborate wiring ensures ease of maintenance
- Optimised passive heat dissipation
- Recorded data can be read out easily via laptop using a USB connection
- Reasonably priced overall system



COMPONENTS AND ACCESSORIES

Besides complete subrack and system solutions HEITEC offers a wide range of individual components and accessories for setup, mounting and upgrade.

Our inside and outside sales staff will gladly help you to find the right selection of components and support you in compiling the optimum package to fulfill your individual preferences and requirements.

Side panels and flanges



→ Page 126

Horizontal rails



→ Page 132

Components for EMC installation



→ Page 145

Extension kits



→ Page 150

Guide rails



→ Page 154

Covers



→ Page 161

Front panels, handles



→ Page 165

Cassettes



→ Page 182

Ventilation



→ Page 190

Power supplies



→ Page 194

Assembly parts



→ Page 202

COMPONENTS AND ACCESSORIES

SIDE PANELS

Side panels for HeiPac Vario

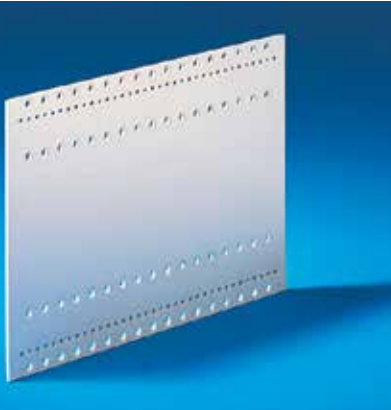

Mounting holes and anti-twist half-shears on a 10 mm pitch pattern.

Material

2.5 mm Aluminium,
Clear-chromated

U			Order No.										
			3	4 (3 + 1)	4 (3 + 2 x 1/2)	6	7 (6 + 1)	7 (6 + 2 x 1/2)	9	10	11		
D (T) mm	a ¹⁾ mm	Packs of											
175	150	1	9901.021	-	-	9901.023	-	-	-	-	-	-	-
185	160	1	3684.511	-	-	3684.529	-	-	-	-	-	-	-
225	200	1	3684.512	3685.793	3685.890	3684.530	3685.896	3685.893	3685.797	-	-	-	-
245	220	1	3684.513	3685.850	3685.891	3684.531	3685.897	3685.894	-	-	-	-	-
285	260	1	3684.514	3684.523	3684.526	3684.532	3685.743	3685.895	-	-	-	-	-
305	280	1	3684.515	3685.794	-	3684.533	-	-	3685.798	-	-	-	-
345	320	1	3684.516	3684.524	3684.527	3684.534	3685.744	3685.745	3684.547	-	-	-	-
365	340	1	3684.517	3685.795	-	3684.535	-	-	3685.799	-	-	-	-
405	380	1	3684.518	3684.525	3684.528	3684.536	3684.541	3684.543	3684.548	3684.545	-	-	-
425	400	1	3684.519	-	-	3684.537	-	-	-	-	-	-	-
465	440	1	3684.520	3685.796	3685.892	3684.538	3684.542	3684.544	3684.549	3684.546	3684.552	-	-
525	500	1	3684.521	9906.727	-	3684.539	3685.898	3685.959	3684.550	3685.899	3684.553	-	-
585	560	1	3684.522	9906.914	-	3684.540	-	-	3684.551	-	3684.554	-	-

¹⁾ a = Distance between the first and last mounting hole.

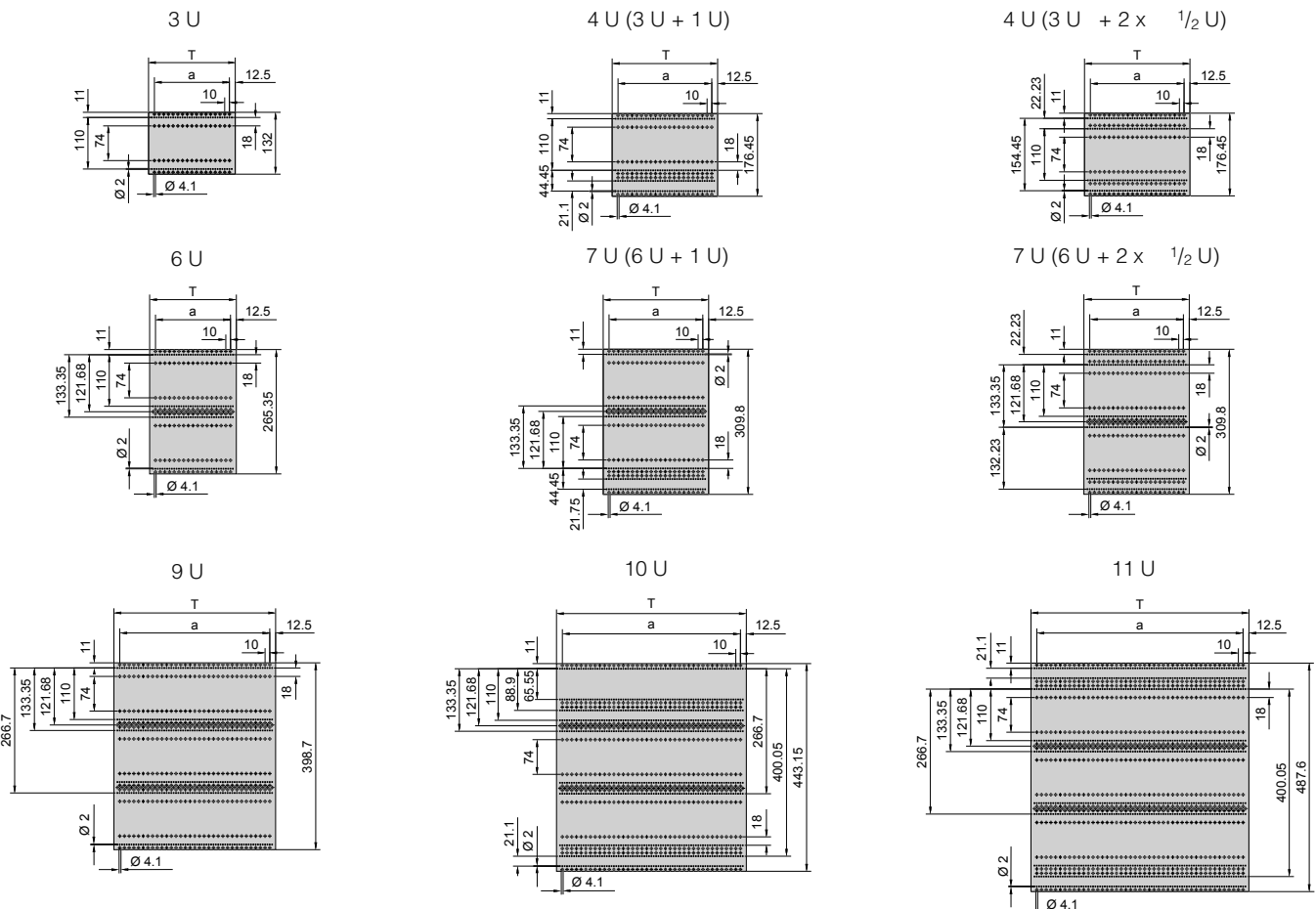

Side panels for HeiPac Vario ECO

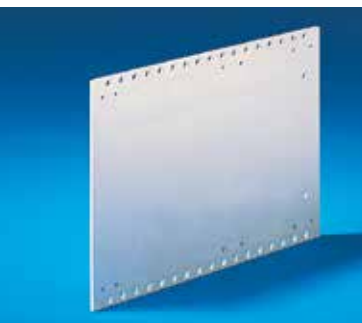

Mounting holes on a 10 mm pitch pattern.

Material

1.5 mm sheet steel
Zinc-plated

D (T) mm	Packs of	Max. board depth mm	Order No.	
			3 U	6 U
175	1	160	3688.100	3688.102
235	1	220	3688.101	3688.103

+ Accessories

Flanges for HeiPac ECO
see page 129

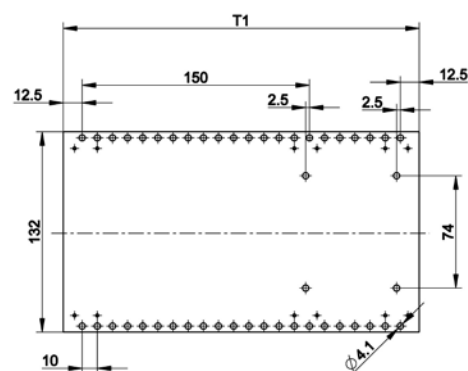
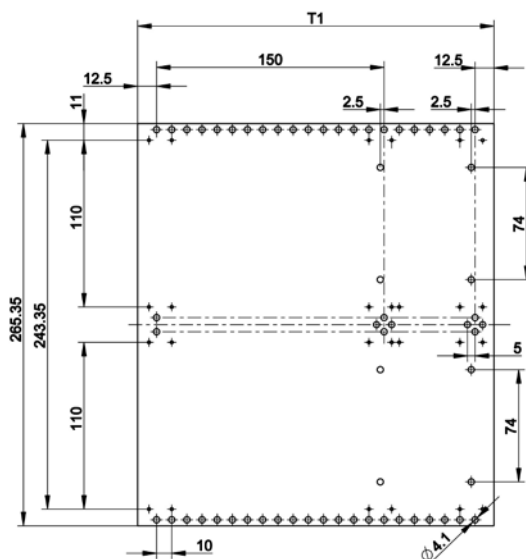

Side panels for HeiPac EASY

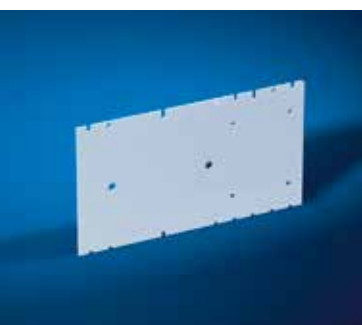

Mounting holes on a 60 mm pitch pattern as long holes
Drill holes for mounting telescopic slides

Material

2 mm Aluminium
Non-corrosive

D (T) mm	L2	n	n1	Packs of	Max. board depth mm	Order No.	
						3 U	6 U
175	-	-	-	2	160	3634.695	3634.720
235	60	-	-	2	220	3634.700	3634.725
295	60	2	2	2	280	3634.705	3634.730
355	60	3	3	2	340	3634.710	3634.735
415	60	4	3	2	400	3634.715	3634.740

- 1** Mounting holes suitable for threaded insert PEM-FM4-1 for mounting telescopic slides

+ Accessories

Flanges for HeiPac EASY
see page 129

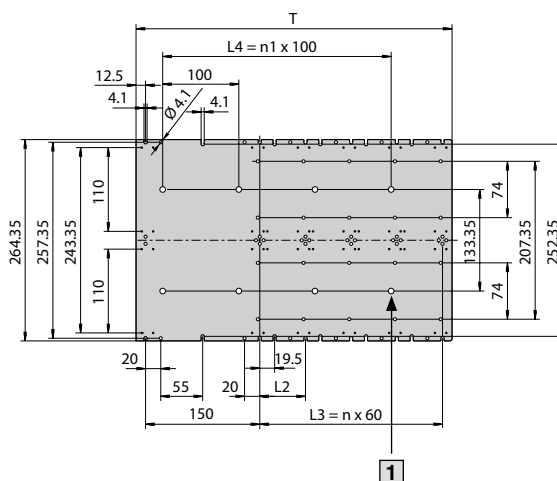
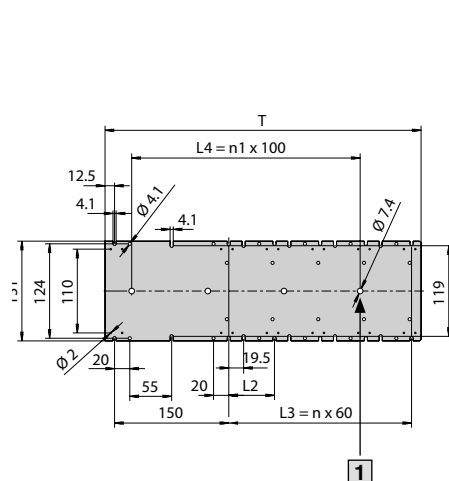

COMPONENTS AND ACCESSORIES FLANGES

Flanges 19" for HeiPac Vario

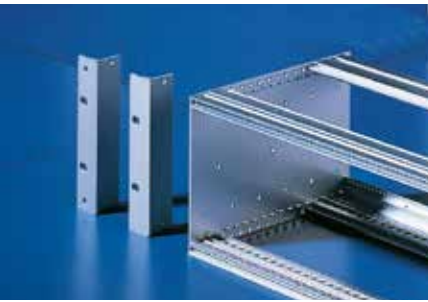

With integral channel to accommodate EMC gaskets.

Material

Extruded aluminum section

Surface finish

Clear-chromated

U	Packs of	Order No.	
		with handle holes	without handle holes
2	1	-	3684.614
3	1	3684.622	3684.615
4	1	3684.623	3684.616
6	1	3684.624	3684.617
7	1	3684.625	3684.618
9	1	-	3684.619
10	1	-	3684.620
11	1	-	3684.621

+ Accessories

EMC gaskets, vertical
see page 146
Handles for subrack
see page 57

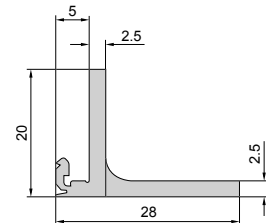
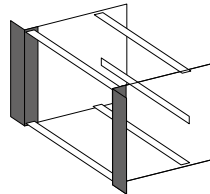

Flanges 19" for HeiPac Vario, set-back



Material

Extruded aluminum section

Surface finish

Clear-chromated

U	Packs of	Order No.
3	1	3684.626
4	1	3684.627
6	1	3684.628
7	1	3684.629
9	1	3684.630
10	1	3684.631
11	1	3684.632

+ Also required

Assembly screws, nuts and washers
packs of 4 sets, Order No. 3687.015
see page 203

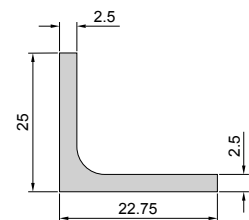
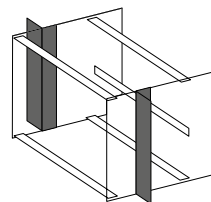

Flanges 19" for HeiPac Vario, reinforced

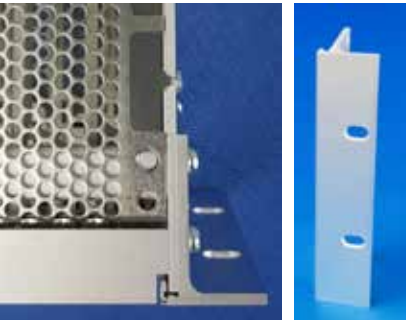

Reinforced flange ensures a high level of stability even under extreme loads.

Material

Extruded aluminum section
3 mm material thickness

Surface finish

Clear-chromated

NEW

U	Packs of	Order No.	
		with handle holes	without handle holes
3	1	9921.725	9914.268
6	1	9921.726	9921.721

+ Accessories

Handles for subrack
see page 57

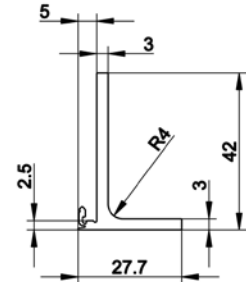
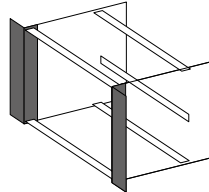

Flanges 19" for HeiPac Vario ECO

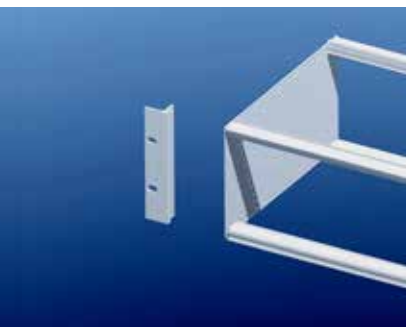

Material

Extruded aluminum section

Surface finish

Clear-chromated

U	Packs of	Order No.
3	1	3688.110
6	1	3688.111

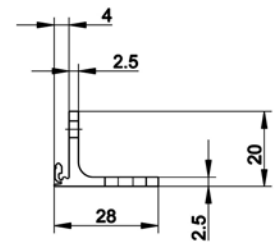
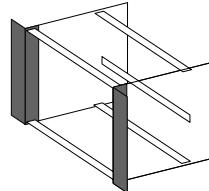

Flanges 19" for HeiPac EASY



Integrated mounting holes for installation of handles

Material

Extruded aluminium section

Surface finish

Pre-anodised

U	Packs of	Order No.
3	2	3634.745
6	2	3634.750

+ Accessories

Handles for subrack
see page 57

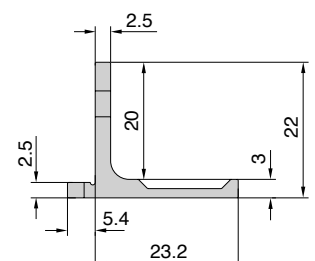
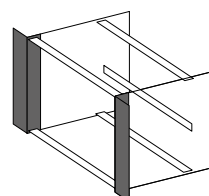

COMPONENTS AND ACCESSORIES

HORIZONTAL RAILS HeiPac Vario HeiPac Vario

Overview horizontal rails HeiPac Vario







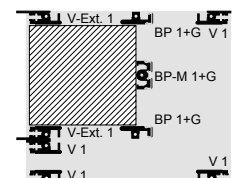
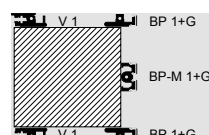
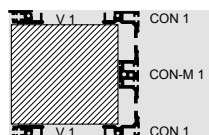























Main sections	V 1	V 2	V 3	V-Ext. 1	V-Ext. 2	V-Ext. 3	V-Ext. 4	BP 1	BP 2
	Front horizontal rail	Front horizontal rail, with double screw fastening	Double front horizontal rail	Front horizontal rail, with 10 mm extension, for extractor handle type IV or VII	Double front horizontal rail, with 10 mm extension	Front horizontal rail, with 10 mm extension, with double screw fastening	Double front horizontal rail, with 10 mm extension	Rear horizontal rail	Rear horizontal rail, with double screw fastening
	Page 132	Page 132	Page 133	Page 133	Page 134	Page 134	Page 135	Page 135	Page 136
Additional sections									
E Adaptor rail, rear centre, to accommodate guide rails 	-	-	-	-	-	-	-	-	-
Page 140									
F Z rail for connector 	-	-	-	-	-	-	-		
Page 144									
G Insulating strip ¹⁾ 	-	-	-	-	-	-	-		
Page 145									
H Conductive strip ²⁾ 	-	-	-	-	-	-	-		
Page 145									
I Threaded insert 								-	
Page 144									
J Identification strips 									
Page 144									
K EMC gaskets, horizontal 								-	-
Page 145									

For ¹⁾insulated or ²⁾conductive attachment of backplanes.

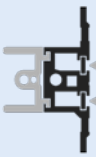
All system requirements may be covered with just a few basic types of horizontal rail. A cost-effective, easy-to-manage range.



Overview horizontal rails HeiPac Vario

Main sections	BP 3 Rear horizontal rail	BP 4 Rear horizontal rail	BP 5 Rear horizontal rail	BP-M 1 Rear horizontal rail, centre	BP-M 2 Rear horizontal rail, centre (also for HeiPac EASY)	CON 1 Rear horizontal rail, with integral Z rail	CON 2 Rear horizontal rail, with integral Z rail	CON-M 1 Rear horizontal rail, with integral Z rail (also for HeiPac EASY)
	Page 136	Page 137	Page 137	Page 138	Page 138	Page 139	Page 139	Page 140
Additional sections								
E Adaptor rail, rear centre, to accommodate guide rails 	-	-	-			-	-	
Page 140								
F Z rail for connector 		-	-		-	-	-	-
Page 144								
G Insulating strip ¹⁾ 		-	-		-	-	-	-
Page 145								
H Conductive strip ²⁾ 		-	-		-	-	-	-
Page 145								
I Threaded insert 		-	-	-	-			
Page 144								
J Identification strips 				-	-		-	-
Page 144								
K EMC gaskets, horizontal 	-	-	-	-	-	-	-	-
Page 145								

For ¹⁾insulated or ²⁾conductive attachment of backplanes.

COMPONENTS AND ACCESSORIES

HORIZONTAL RAILS HeiPac Vario

Horizontal rail Vario V 1, front



To accommodate guide rails and for the attachment of front panels

- Front projection 2.5 mm corresponding to IEC 60 297-3-101
- HP pitch pattern of holes for the precise installation of guide rails
- M4 thread on end face
- Straight-through core hole
- Horizontal rail 192 HP without machining on the end faces. Suitable for cutting to length

Material

Extruded aluminium section

Surface finish

Clear-chromated

Usable width (HP)	Packs of	Order No. unprinted	Order No. printed
4 (left)	1	3684.592	-
4 (right)	1	3684.955	-
8 (left)	1	3684.593	-
8 (right)	1	3684.956	-
12	1	3684.594	-
16	1	3684.595	-
20	1	3684.596	-
21	1	3685.985	-
40	1	3684.960	-
42	1	3684.560	9921.788³⁾
63	1	3684.561	-
84	1	3684.562	9921.789³⁾
84	2	3685.267¹⁾	-
192	1	3688.000²⁾	-

¹⁾ Including 4 assembly screws

²⁾ Anodised

³⁾ with HP pattern printing

+ Also required

Assembly screws M4 x 12
Packs of 100, order no. 3654.300
see page 202

+ Accessories

Threaded inserts, packs of 1, order no. 3684.610
see page 144

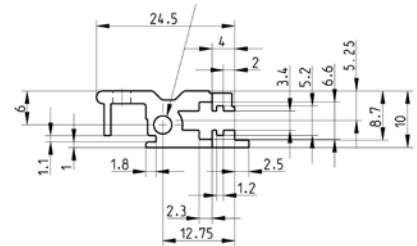
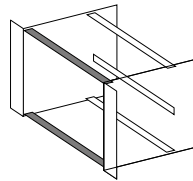

Horizontal rail Vario V 2, front, with double screw fastening



To accommodate guide rails and for the attachment of front panels. The double screw fastening ensures a high level of stability even under extreme loads.

- Front projection 2.5 mm corresponding to IEC 60 297-3-101
- HP pitch pattern of holes for the precise installation of guide rails
- M4 thread on end face
- Straight-through core hole
- Load test to DIN EN/IEC 61 587-1, requirement level SL1
- Shock and vibration tests undertaken as per IEC 61 373 (DIN EN 50 155), Category 1, Class B

Material

Extruded aluminium section

Surface finish

Clear-chromated

Usable width (HP)	Packs of	Order No. unprinted	Order No. printed
84	1	9908.721	9921.793¹⁾

¹⁾ with HP pattern printing

+ Also required

Assembly screws M4 x 12
Packs of 100, order no. 3654.300
see page 202

+ Accessories

Threaded inserts, packs of 1, order no. 3684.610
see page 144

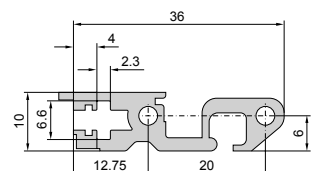
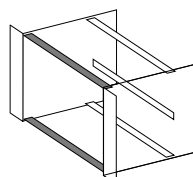

Horizontal rail Vario V 3, front



NEW

To accommodate guide rails and for the attachment of front panels. For subdivision i. e. 6 U in 2 x 3 U.

- Front projection 2.5 mm corresponding to IEC 60 297-3-101
- HP pitch pattern of holes for the precise installation of guide rails
- M4 thread on end face
- Straight-through core hole

Material

Extruded aluminium section

Surface finish

Clear-chromated

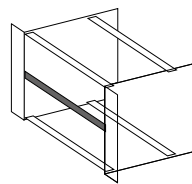

Usable width (HP)	Packs of	Order No. unprinted	Order No. printed
84	1	9904.745	9921.799¹⁾

¹⁾ with HP pattern printing

+ Also required

Assembly screws M4 x 12
Packs of 100, order no. 3654.300
see page 202

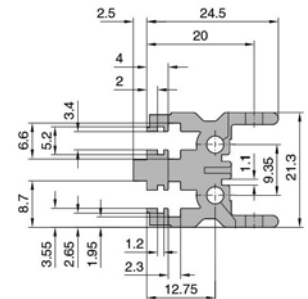

Horizontal rail Vario V-Ext. 1, front, with 10 mm extension



For type IV, IVs and VII injector/extractor handle

To accommodate guide rails and for the attachment of front panels.

- Front projection 10 mm corresponding to IEEE 1101.10 and IEC 60 297-3-102
- HP pitch pattern of holes for the precise installation of guide rails
- M4 thread on end face
- Straight-through core hole

Material

Extruded aluminium section

Surface finish

Clear-chromated

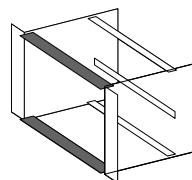

Usable width (HP)	Packs of	Order No. unprinted	Order No. printed
40	1	3684.961	-
42	1	3684.565	9921.790³⁾
63	1	3684.566	-
84	1	3684.567	9921.791³⁾
84	2	3685.269¹⁾	-
192	1	3688.001²⁾	-

¹⁾ Including 4 assembly screws

²⁾ Anodised

³⁾ with HP pattern printing

+ Also required

Assembly screws M4 x 12
Packs of 100, order no. 3654.300
see page 202

+ Accessories

Threaded inserts, packs of 1, order no. 3684.610
see page 144

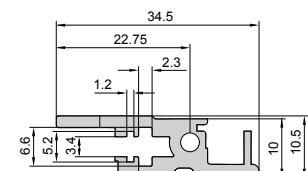

COMPONENTS AND ACCESSORIES

HORIZONTAL RAILS HeiPac Vario

Horizontal rail Vario V-Ext. 2, with 10 mm extension and double screw fastening, front

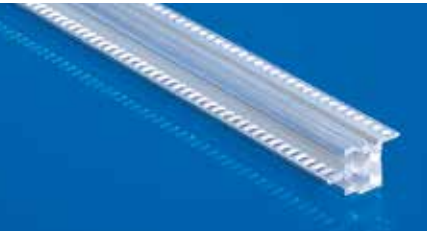

For type IV, IVs and VII injector/extractor handle

To accommodate guide rails and for the attachment of front panels. Double screw fastening and an extra high profile section ensure unique stability evens under extreme loads.

- Front projection 10 mm corresponding to IEE 1101.10 and IEC 60 297-3-102
- HP pitch pattern of holes for the precise installation of guide rails
- M4 thread on end face
- Straight-through core hole

Material

Extruded aluminium section

Surface finish

Clear-chromated

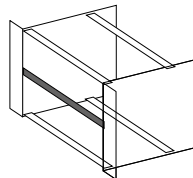

Usable width (HP)	Packs of	Order No.
84	1	3687.724

+ Also required

Assembly screws M4 x 12
Packs of 100, order no. 3654.300
see page 202

+ Accessories

Threaded inserts, packs of 1, order no. 3684.610
see page 144

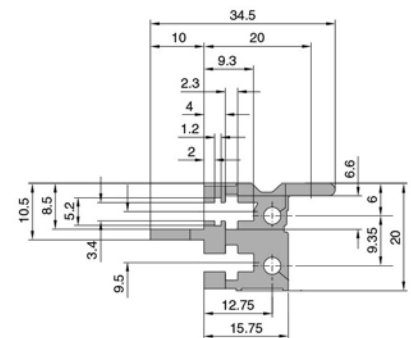

Horizontal rail Vario V-Ext. 3, with 10 mm extension and double screw fastening, front



For type IV, IVs and VII injector/extractor handle

To accommodate guide rails and for the attachment of front panels. The double screw fastening ensures a high level of stability even under extreme loads.

- Front projection 10 mm corresponding to IEE 1101.10 and IEC 60 297-3-102
- HP pitch pattern of holes for the precise installation of guide rails
- M4 thread on end face
- Straight-through core hole

Material

Extruded aluminium section

Surface finish

Clear-chromated

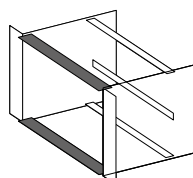

Usable width (HP)	Packs of	Order No. unprinted	Order No. printed
84	1	9908.722	9921.795 ¹⁾

¹⁾ with HP pattern printing

+ Also required

Assembly screws M4 x 12
Packs of 100, order no. 3654.300
see page 202

+ Accessories

Threaded inserts, packs of 1, order no. 3684.610
see page 144

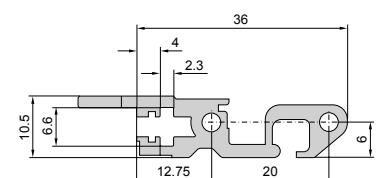

Horizontal rail Vario V-Ext. 4, with 10 mm extension and double screw fastening, front

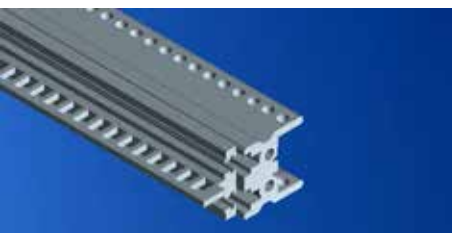

NEW

For type IV, IVs and VII injector/extractor handle

For subdivision i. e. 6 U in 2 x 3 U. To accommodate guide rails and for the attachment of front panels

- Front projection 10 mm corresponding to IEEE 1101.10 and IEC 60 297-3-102
- HP pitch pattern of holes for the precise installation of guide rails
- M4 thread on end face
- Straight-through core hole

Material

Extruded aluminium section

Surface finish

Clear-chromated

Usable width (HP)	Packs of	Order No.
84	1	3688.704

+ Also required

Assembly screws M4 x 12
Packs of 100, order no. 3654.300
see page 202

+ Accessories

Threaded inserts, packs of 1, order no. 3684.610
see page 144

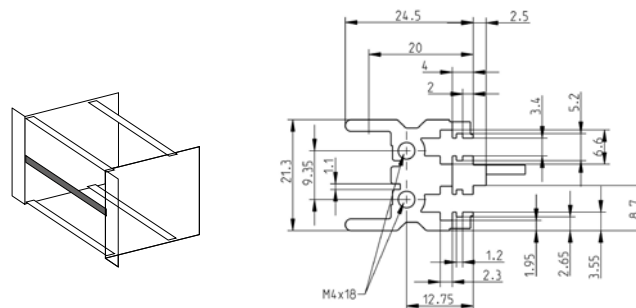

Horizontal rail Vario BP 1, for backplane



To accommodate guide rails and for the attachment of Z rails, insulating strips or conductive strips.

- Tapped holes M2.5 on a 1 HP pitch pattern for mounting backplanes and Z rails
- HP pitch pattern of holes for the precise installation of guide rails
- M4 thread on end face
- Applicable for top-mounting under covers
- Straight-through core hole
- Horizontal rail 192 HP without machining on the end faces. Suitable for cutting to length

Material

Extruded aluminium section

Surface finish

Clear-chromated

Usable width (HP)	Packs of	Order No.
21	1	3685.991
40	1	3684.962
42	1	3684.570
63	1	3684.571
84	1	3684.572
84	2	3685.268¹⁾
192	1	3688.002²⁾

1) Including 4 assembly screws

2) Anodised

+ Also required

Assembly screws M4 x 12
Packs of 100, order no. 3654.300
see page 202

+ Accessories

Conductive strips
see page 145
Insulating strips
see page 145
Z rail
see page 144

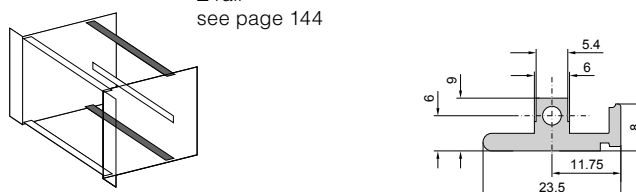

COMPONENTS AND ACCESSORIES

HORIZONTAL RAILS HeiPac Vario

Horizontal rail Vario BP 2, for backplane



To accommodate guide rails and for the attachment of Z rails, insulating strips or conductive strips. The double screw fastening ensures a high level of stability even under extreme loads.

- HP pitch pattern of holes for the precise installation of guide rails
- M4 thread on end face
- For mounting backplanes/Z rails additional threaded inserts (9901.816) are required
- Straight-through core hole

Material

Extruded aluminium section

Surface finish

Clear-chromated

Usable width (HP)	Packs of	Order No.
84	1	9908.723

+ Also required

Assembly screws M4 x 12
Packs of 100, order no. 3654.300
see page 202

+ Accessories

Threaded inserts, packs of 1, order no. 9901.816
see page 144

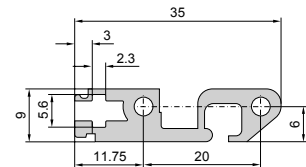
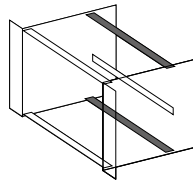

Horizontal rail Vario BP 3, for backplane

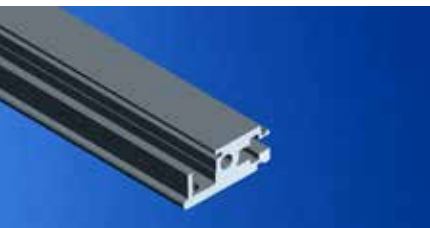

To accommodate guide rails and for the attachment of Z rails, insulating strips or conductive strips.

- HP pitch pattern of holes for the precise installation of guide rails
- Channel for slide-in covers
- Additional threaded inserts (3684.610) are required for mounting backplanes/Z rails
- M4 thread on end face
- Straight-through core hole
- Not suitable for mounting under covers

Material

Extruded aluminium section

Surface finish

Clear-chromated

Usable width (HP)	Packs of	Order No.
84	1	3688.104

+ Also required

Assembly screws M4 x 12
Packs of 100, order no. 3654.300
see page 202

+ Accessories

Threaded inserts, packs of 1, order no. 3684.610
see page 144
Insulating strips
see page 145
Conductive strips
see page 145

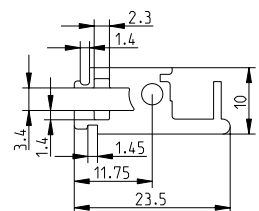
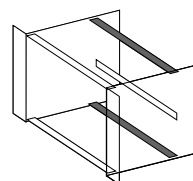

Horizontal rail Vario BP 4, for conductive mounting of backplanes

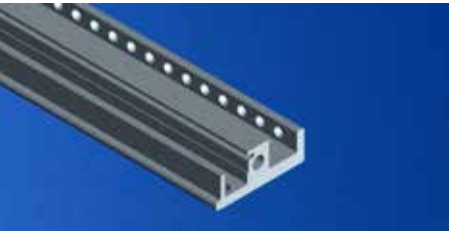

To accommodate guide rails and for the conductive attachment of backplanes

- HP pitch pattern of holes for the precise installation of guide rails
- Tapped holes M2.5 on a HP pitch pattern
- Channel for slide-in covers
- M4 thread on end face
- Straight-through core hole
- Not suitable for mounting under covers
- For mounting slide-in covers
- Due to integrated contact area, insulating strips cannot be used

Material

Extruded aluminium section

Surface finish

Clear-chromated

Usable width (HP)	Packs of	Order No.
84	1	9920.069

+ Also required

Assembly screws M4 x 12
Packs of 100, order no. 3654.300
see page 202

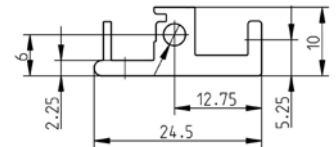
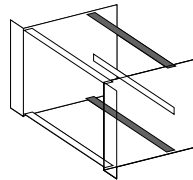

Horizontal rail Vario BP 5, for conductive mounting of backplanes



To accommodate guide rails and for the conductive mounting of backplanes

- Tapped holes M2.5 on a HP pitch pattern
- HP pitch pattern of holes for the precise installation of guide rails
- Due to integrated contact area, insulating strips cannot be used
- Applicable for top-mounting under covers
- M4 thread on end face
- Straight-through core hole

Material

Extruded aluminium section

Surface finish

Clear-chromated

Usable width (HP)	Packs of	Order No.
84	1	9912.522

+ Also required

Assembly screws M4 x 12
Packs of 100, order no. 3654.300
see page 202

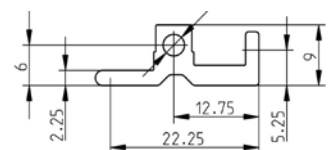
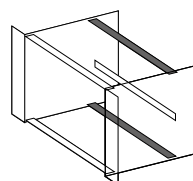

COMPONENTS AND ACCESSORIES

HORIZONTAL RAILS HeiPac Vario

Horizontal rail Vario BP-M 1, for backplane, centre

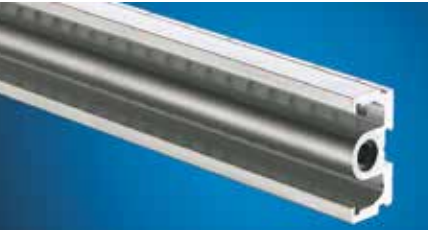

When using 6 U PCBs or box-type plug-in units. Facility for the attachment of Z rails, insulating strips or conductive strips.

- Tapped holes M2.5
- M4 thread on end face
- Straight-through core hole
- Horizontal rail 192 HP for cutting to the required length

Material

Extruded aluminium section

Surface finish

Clear-chromated

Usable width (HP)	Packs of	Order No.
40	1	3684.963
42	1	3684.580
63	1	3684.581
84	1	3684.582
84	1	3685.270 ¹⁾
168	1	3684.579
192	1	3688.003 ²⁾

¹⁾ Including 2 assembly screws

²⁾ Anodised

+ Also required

Assembly screws M4 x 12
Packs of 100, order no. 3654.300
see page 202

+ Accessories

Insulating strips, see page 145
Conductive strips, see page 145
Z rails, see page 144

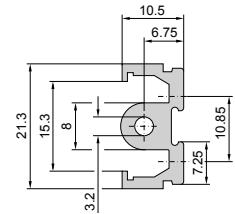
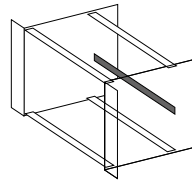

Horizontal rail Vario BP-M 2, for backplane, centre

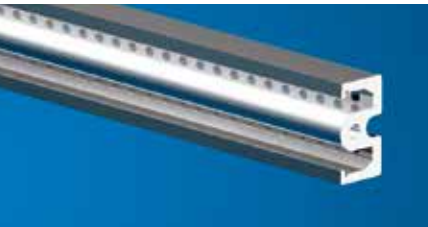

When using 6 U PCBs or box-type plug-in units. Facility for the attachment of Z rails or backplanes.

- Tapped holes M2.5
- M4 thread on end face
- Straight-through core hole
- Due to integrated contact area, insulating strips cannot be used

Material

Extruded aluminium section

Surface finish

Clear-chromated

Usable width (HP)	Packs of	Order No.
84	1	9912.523

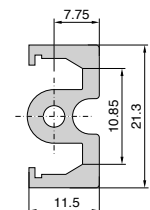
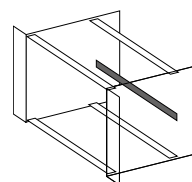

Horizontal rail Vario CON 1, with integral Z rail for connector

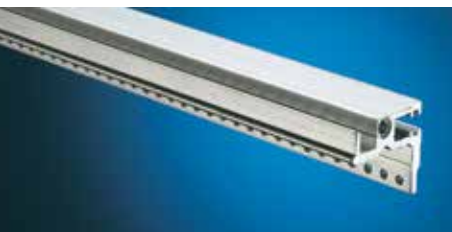

To accommodate guide rails. Integral Z rail for mounting connectors (CON) to IEC 60 603-2.

- HP pitch pattern of holes for the precise installation of guide rails
- Tapped holes M2.5 for connector mounting
- Applicable for top-mounting under covers
- M4 thread on end face
- Straight-through core hole

Material

Extruded aluminium section

Surface finish

Clear-chromated

Usable width (HP)	Packs of	Order No.
42	1	3686.191
63	1	3686.919
84	1	3686.159

+ Also required

Assembly screws M4 x 12
Packs of 100, order no. 3654.300
see page 202

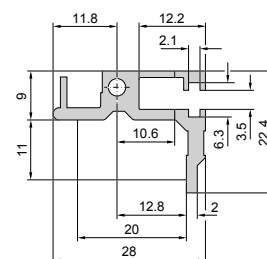
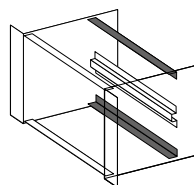

Horizontal rail Vario CON 2, with integral Z rail for connector

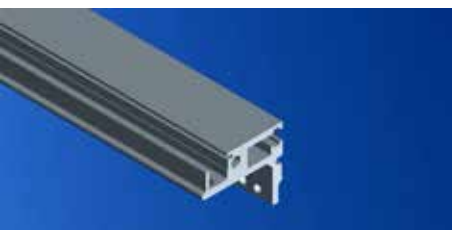

To accommodate guide rails. Integral Z rail for mounting connectors (CON) to DIN 41612

- HP pitch pattern of holes for the precise installation of guide rails
- 84 tapped holes M2.5 for connector mounting
- Not suitable for mounting under covers
- M4 thread on end face
- Straight-through core hole

Material

Extruded aluminium section

Surface finish

Clear-chromated

Usable width (HP)	Packs of	Order No.
84	1	9901.991

+ Also required

Assembly screws M4 x 12
Packs of 100, order no. 3654.300
see page 202

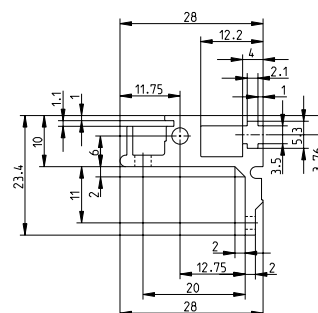
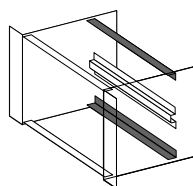

COMPONENTS AND ACCESSORIES

HORIZONTAL RAILS HeiPac Vario

Horizontal rail Vario CON-M 1, with integral Z rail for connector, rear centre



When using 6 U PCBs or box-type plug-in units. Integral Z rail for mounting connectors (CON) to IEC 60 603-2

- Tapped holes M2.5
- M4 thread on end face
- Straight-through core hole

Material

Extruded aluminium section

Surface finish

Clear-chromated

Usable width (HP)	Packs of	Order No.
42	1	3687.600
63	1	3687.601
84	1	3687.602
168	1	3687.603

+ Also required

Assembly screws M4 x 12
Packs of 100, order no. 3654.300
see page 202

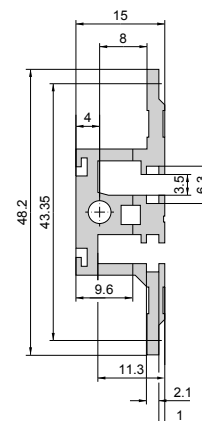
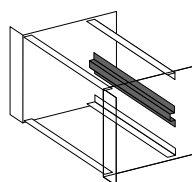

Adaptor rail, rear centre (E)



When subdividing 6 U into 2 x 3 U, the adaptor rail accommodates the guide rails when fastened to the centre horizontal rail.

- HP pitch pattern of holes for the precise installation of guide rails
- M4 and M2.5 thread on the end face
- Applicable in combination with BP-M 1, BP-M 2 and EST-M 1
- Straight-through core hole
- Horizontal rail 192 HP without machining on the end faces. Suitable for cutting to length

Material

Extruded aluminium section

Surface finish

Clear-chromated

Usable width (HP)	Packs of	Order No.
12	1	3684.587
16	1	3684.588
20	1	3684.589
40	1	3684.964
42	1	3684.590
63	1	3686.005
84	1	3684.591
84	1	3685.272¹⁾
168	1	3684.584
192	1	3688.004²⁾

¹⁾ Including 4 assembly screws

²⁾ Anodised

+ Also required

Assembly screws M4 x 12
Packs of 100, order no. 3654.300
see page 202

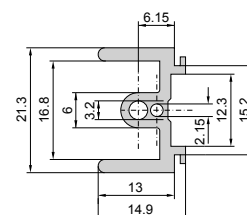
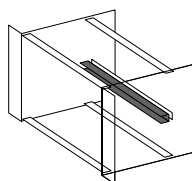

Overview horizontal rails HeiPac EASY

Main sections	EASY V 1 Front horizontal rail, with double screw fastening	EASY BP 1 Rear horizontal rail, with double screw fastening, for mounting backplanes	EASY CON 1 Rear horizontal rail, with double screw fastening, with integral Z rail	EASY H 1 Rear horizontal rail, with double screw fastening, for mounting rear panels
	Page 142	Page 142	Page 143	Page 143
Additional sections				
E Adaptor rail, rear centre, to accommodate guide rails  Page 140	-	-	-	-
F Z rail for connector  Page 144	-	-	-	-
G Insulating strip ¹⁾  Page 145	-	-	-	-
H Conductive strip ²⁾  Page 145	-	-	-	-
I Threaded insert  Page 144		-		
J Identification strips  Page 144	-	-	-	-
K EMC gaskets, horizontal  Page 145	-	-	-	-

For ¹⁾insulated or ²⁾conductive attachment of backplanes.

COMPONENTS AND ACCESSORIES

HORIZONTAL RAILS HeiPac EASY

Horizontal rail EASY V 1, with double screw fastening, front



To accommodate guide rails and for the attachment of front panels

- Pre-assembled screws M 4x16 for fast mounting on the subrack side panel
- Front excess length 2.5 mm corresponding to IEC 60 297-3
- HP pitch pattern of holes for the precise installation of guide rails
- On request with double screw fastening to ensure a high stability
- M4 thread on end face
- Straight-through core hole for optional double screw fastening

Material

Extruded aluminium section

Surface finish

Non-corrosive

Supply includes

2 horizontal rails with pre-assembled threaded inserts and screws M4 x 16

Usable width (HP)	Packs of	Order No. unprinted	Order No. printed
84	2	3634.600	9921.803 ¹⁾

¹⁾ with HP pattern printing

+ Also required

Assembly screws M4 x 16 for double screw fastening, order no. 3634.430 (packs of 100)

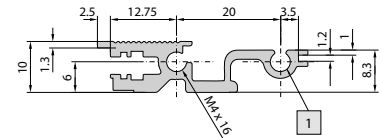
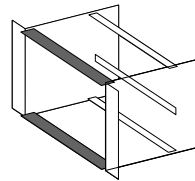

1 Core hole M4

Horizontal rail EASY BP 1, with double screw fastening, for backplane



To accommodate guide rails and for the attachment of backplanes

- Pre-assembled screws M 4x16 for fast mounting on the subrack side panel
- Due to integrated contact area, insulating strips cannot be used
- Tapped holes M2.5 in 1 HP pitch pattern for mounting backplanes
- HP pitch pattern of holes for the precise installation of guide rails
- On request with double screw fastening to ensure a high stability
- M4 thread on end face
- Height of the profile allows cover extension
- Straight-through core hole for optional double screw fastening

Material

Extruded aluminium section

Surface finish

Non-corrosive

Supply includes

2 horizontal rails with pre-assembled threaded inserts and screws M4 x 16

Usable width (HP)	Packs of	Order No.
84	2	3634.615

+ Also required

Assembly screws M4 x 16 for double screw fastening, order no. 3634.430 (packs of 100)

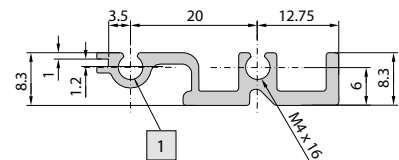
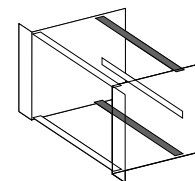

1 Core hole M4

Horizontal rail EASY CON 1, with integral Z rail for connector, with double screw fastening

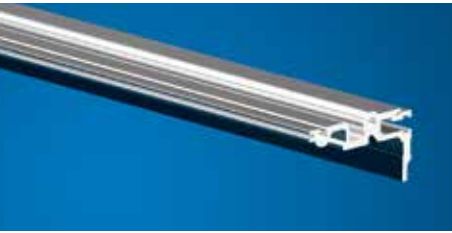

To accommodate guide rails, integral Z rail for the attachment of connectors (CON)

- Pre-assembled screws M 4x16 for fast mounting on the subrack side panel
- On request with double screw fastening to ensure a high stability
- HP pitch pattern of holes for precise mounting of guide rails
- M4 thread on end face
- Straight-through core hole for optional double screw fastening
- Height of the profile allows cover extension

Material

Extruded aluminium section

Surface finish

Non-corrosive

Supply includes

2 horizontal rails with pre-assembled screws M4 x 16

Usable width (HP)	Packs of	Order No.
84	2	3634.620

+ Also required

Threaded inserts, packs of 1, order no. 9901.816 see page 144

+ Also required

Assembly screws M4 x 16 for double screw fastening, order no. 3634.430 (packs of 100)

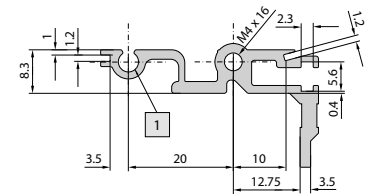
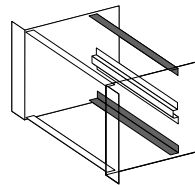

1 Core hole M4

Horizontal rail EASY H 1, with double screw fastening, for mounting rear panels



To accommodate rear front panels

- With channel for mounting top covers see page 164 Covers EASY version 2
- On request with double screw fastening to ensure a high stability
- Straight-through core hole for optional double screw fastening
- M4 thread on end face
- Pre-assembled screws M 4x16 for fast mounting on the subrack side panel

Material

Extruded aluminium section

Surface finish

Non-corrosive

Supply includes

2 horizontal rails with threaded inserts and screws M4 x 16

Usable width (HP)	Packs of	Order No.
84	1	3634.510

+ Also required

Assembly screws M4 x 16 for double screw fastening, order no. 3634.430 (packs of 100)

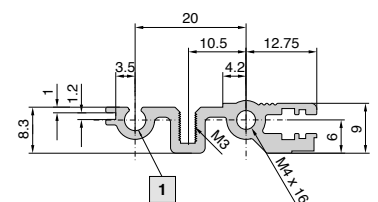

1 Core hole M4

COMPONENTS AND ACCESSORIES

ACCESSORIES FOR HORIZONTAL RAILS

Z rail (F) for connector, IEC 60 603-2



With M2.5 threaded holes

Material

Extruded aluminium section

Surface finish

Clear-chromated

Usable width (HP)	Packs of	Order No.
4	1	3684.597
8	1	3684.598
20	1	3684.599
40	1	3684.965
42	1	3684.600
63	1	3684.601
84	1	3684.602
84	2	3685.271

+ Also required

Assembly screws M2.5 x 6,
Packs of 100, order no. 3654.340,
see page 202

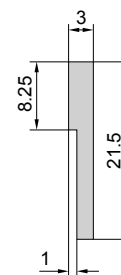

Threaded insert (I)



With M2.5 threaded holes on an HP pitch pattern. For sliding into the horizontal rail. There are two threaded insert versions, which are distinguished by their height.

Material

Sheet steel, zinc-plated

Usable width (HP)	Packs of	Order No.	
		6 x 2 mm	5 x 2 mm
		for horizontal rails	
		Type	Type
		V 1, V 2	EASY V 1
		V-Ext. 1	EASY EST 1
		V-Ext. 2	EASY BP 1
		V-Ext. 3	EASY H 1
		EST 1	
3	1	3684.603	-
7	1	3684.604	-
12	1	3684.605	-
16	1	3684.606	-
20	1	3684.607	-
21	1	3686.149	-
40	1	3684.966	-
42	1	3684.608	-
63	1	3684.609	-
84	1	3684.610	9901.816

Identification strip (J)



To identify the slots on the subrack, self-adhesive.
The following versions are available:

4 mm wide:

- for front horizontal rails
- for rear horizontal rails

2 mm wide:

- for front horizontal rails (channel on front face)

For horizontal rail	Width mm	Label	Packs of	Order No.
Front	4	1 ... 83	1	3687.575
Rear	4	1 ... 167	1	3687.577
Front	4	83 ... 1	1	3687.574
Front	2	1 ... 84	1	3687.576

COMPONENTS AND ACCESSORIES ACCESSORIES FOR HORIZONTAL RAILS

EMC gaskets (K) for front horizontal rails

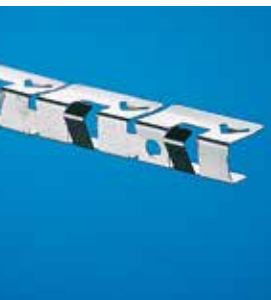

For horizontal EMC protection.
For snapfastening onto the front horizontal rails.

Material

Stainless steel

European patent
no. 0 937 375 with validity
for DE

US patent no. 6,137,052

Chinese patent
no. ZL 97 1 98582.0

EMC

Usable width (HP)	Packs of	Order No.
For top/bottom horizontal rail		
40	1	3684.974
40	10	9921.945
84	1	3684.808
84	10	3684.246
For sub-division of 6 U into 2 x 3 U, between 2 horizontal rails		
84	1	3685.789
84	10	3685.229



Conductive strip (H)



For conductive mounting of backplanes.

- 84 HP
- Slides onto the rear horizontal rail

Material

Aluminium

Usable width (HP)	Packs of	Order No.
84	1	3684.612
84	2	3685.273

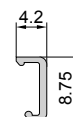

Insulating strip (G)



For insulated mounting of backplanes

- 21 HP
- Slides onto the rear horizontal rail

Material

Plastic, self-extinguishing to UL 94-V0

Usable width (HP)	Packs of	Order No.
21	1	3684.611
21	8	3685.274

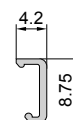

Punched strip



Material

Aluminium

Usable width (HP)	Packs of	Order No.
84	2	3685.275

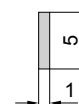

COMPONENTS AND ACCESSORIES

COMPONENTS FOR EMC INSTALLATION

EMC gaskets, vertical



To ensure EMC protection between the subrack side panel and the front/rear panels. There are two versions available.

Suitable for mounting on:

- 482.6 mm (19") flanges for subracks
- Corner trims, rear
- EMC contact strip
- U-channel front panels
- Trim panels for HeiPac Vario-Module
- Flanges for HeiPac Vario-Module

Material

Stainless steel

German patent
no. 101 15 525 and
no. 198 46 627
US patent no. 6,500,012
US patent no. 7,044,753

EMC

Version 1: Segmented

U	Order No. Packs of 1	Order No. Packs of 10
1	3686.973	3684.236
2	3686.974	3684.237
3	3686.975	3684.238
4	3686.976	3684.239
6	3686.977	3684.240
7	3686.978	3684.241
9	3686.979	3684.242
10	3686.980	3684.243
11	3686.981	3684.244

Version 2: One-piece

U	Order No. Packs of 1	Order No. Packs of 10
2	3688.610	-
3	3688.611	9921.942
4	3688.612	-
5	3688.613	-
6	3688.614	9921.943
7	3688.615	-
8	3688.634	-
9	3688.616	9921.944
10	3688.609	-
11	3688.633	-
12	3688.606	-



EMC contact strip



To ensure EMC protection when horizontal rails are set-back. Integral channel to accommodate EMC gaskets.

Material

Extruded aluminium section

Surface finish

Clear-chromated

Note

2 sections are required for each subrack.

U	Packs of	Order No.
3	1	3684.643
6	1	3684.644
9	1	3684.645

+ Also required

EMC gaskets, vertical, see page 146
Assembly screws M3 x 6, packs of 100,
order no. 3684.233, see page 202

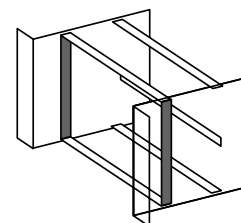

EMC gaskets for covers



For EMC shielding between the horizontal rails and covers.

Material

Stainless steel

HP	Packs of	Order No.
40	1	3684.975
84	1	3684.807
84	10	3684.245

EMC

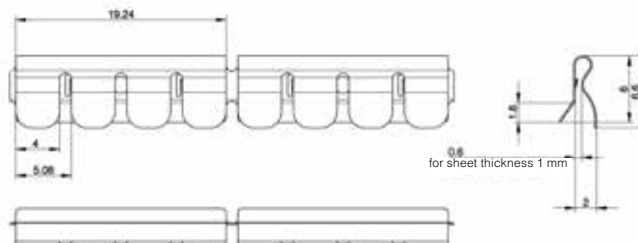

EMC gaskets for front horizontal rails

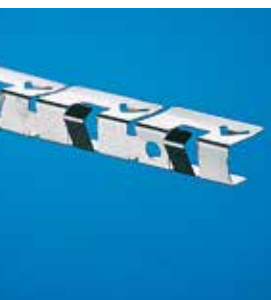

For horizontal EMC protection. For snapfastening onto the front horizontal rails.

Material

Stainless steel

European patent no. 0 937 375 with validity for DE
US patent no. 6,137,052
Chinese patent no. ZL 97 1 98582.0

Usable width (HP)	Packs of	Order No.
For top/bottom horizontal rail		
40	1	3684.974
40	10	9921.945
84	1	3684.808
84	10	3684.246
For sub-division of 6 U into 2 x 3 U, between 2 horizontal rails		
84	1	3685.789
84	10	3685.229

EMC



COMPONENTS AND ACCESSORIES

MOUNTING COVERS/COMPONENTS FOR EMC INSTALLATION

Mounting blocks for cover plates



For mounting covers, versions 1 – 4, on the subrack side panel.

Material

Die-cast zinc

Surface finish

Nickel-plated

Note

For EMC applications, mounting blocks must be fitted across the entire subrack depth. The table here shows the number of mounting blocks required to install 1 cover plate with EMC shielding.

	Packs of	Order No.
Mounting blocks 28.5 mm long	10	3684.234

Number of mounting blocks for max. EMC protection	Cover plate depth mm
4	142
8	192
10	212
12	252
14	272
16	312
18	332
20	372
24	432
28	492
32	552

EMC

+ Also required

Assembly screws M3 x 6, packs of 100, order no. 3684.233, see page 202

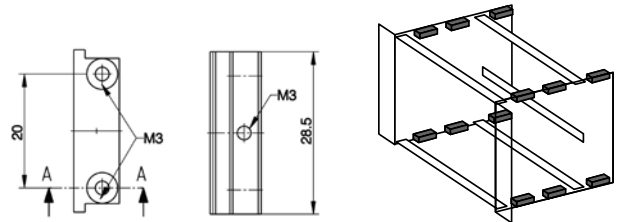

Mounting clips for cover plates

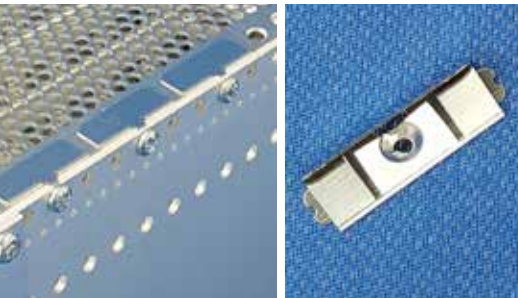

For mounting covers on the subrack side panel

Compatible with cover plate versions 1-4 and the ECO and EASY versions, and with sheet metal blanks 0.8-1.0 mm thick. For EMC applications, mounting clips must be fitted across the full depth of the subrack.

Material

Stainless steel

Length mm	n	Packs of	Order No.
30	1	1	3688.109
90	3	1	9921.722
120	4	1	9921.883
150	5	1	9921.723
180	6	1	9921.884
210	7	1	9921.724
240	8	1	9921.885

+ Also required

Assembly screws, order no. 9921.879

NEW

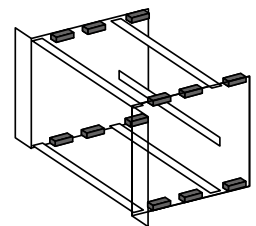
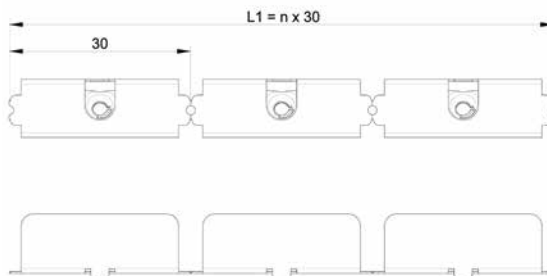

EMC

Back cover

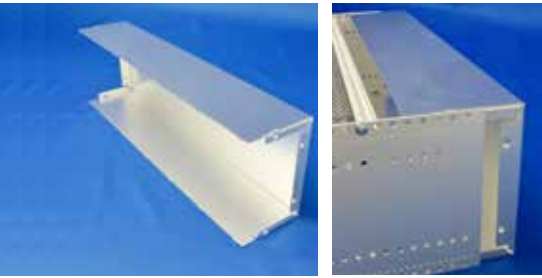

NEW

For HeiPac Vario

Ensures cover for back of subrack

Material

Aluminium

Surface finish

Clear-chromated

Note

The side panel depth required is obtained by taking the length of the plug-in units used, and adding 85 mm (refer to table). A precondition is the use of a horizontal rail that allows room for additional construction.

U	Packs of	Order No.
3	1	9921.685
6	1	9921.710

PCB depth mm	Side panel depth mm
160	245
220	305
280	365

Horizontal rail that allows room for additional construction

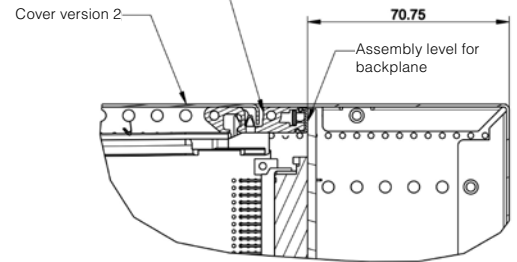

COMPONENTS AND ACCESSORIES

MOUNTING KITS

Vertical divider kit



For the combined installation of single and double Eurocards in 6 U and 9 U subracks.

Material

Aluminium, clear-chromated

Supply includes

2 front horizontal rails
1 adaptor rail
2 threaded inserts
1 vertical support (from 12 HP)
assembly parts

6 U (2 x 3 U)

HP	HP	Order No.
1 (2 x 3 U)	2 (6 U)	
14	68	3684.220
21	61	3684.221
28	54	3684.222
40	42	3684.223
42	40	3684.224

9 U (1 x 6 U + 1 x 3 U)

HP	HP	Order No.
(1 x 6 + 1 x 3 U)	(9 U)	
4	80	3684.225
8	76	3684.226
12	70	3684.227
16	66	3684.228
20	62	3684.229

+ Accessories

Front panel, see page 150

EMC gaskets, horizontal, see page 147

Vertical support



Required for the combined installation of single, double and triple Eurocards in one subrack.

Material

Aluminium, extruded

Surface finish

Clear-chromated

U	Packs of	Order No.
6	1	3684.678
9	1	3684.679

Front panel to conceal the vertical support of the vertical divider kit



To conceal the vertical support of the vertical divider kit.

Material

Aluminium, extruded

Supply includes

Assembly parts

EMC version,
see page 179

U	HP	Packs of	Order No.
6	2	1	3685.176
9	2	1	3685.286

Horizontal mounting kit

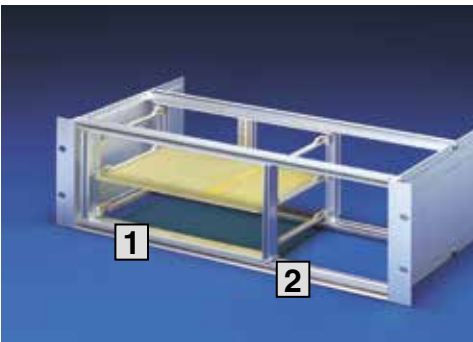

Für den horizontalen Einbau von
6 HE/9 HE Leiterplatten in 3 HE/4 HE
Baugruppenträgern

- 1** Horizontal installation space:
3 U subrack: 20 HP (5 slots)
4 U subrack: 28 HP (7 slots)
- 2** Vertical installation space:
(when installing double
Eurocards)
31 HP (without trim frame)
28 HP (with trim frame)

Material

Aluminium, clear-chromated

Supply includes

2 horizontal rails, front
2 horizontal rails, rear
1 or 2 horizontal rails, rear, centre
2 threaded inserts
4 or 6 insulating strips
4 connecting parts
assembly parts

For backplane assembly
with standard horizontal rail, front

U horizontal	Order No.	
	for 3 U subrack	for 4 U subrack
6	3684.206	3684.208
9	3684.207	3684.209

For backplane assembly,
front horizontal rail with 10 mm extension

U horizontal	Order No.	
	for 3 U subrack	for 4 U subrack
6	3684.210	3684.212
9	3684.211	3684.213

+ Accessories

Trim frame,
see page 151

Trim frame for horizontal mounting kit

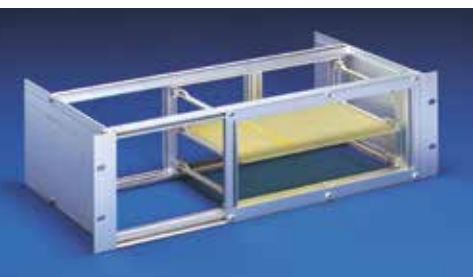

To conceal the front sections of the
horizontal mounting kit.

Material

Aluminium, anodised

U horizontal	HP	Order No.	
		for 3 U subrack	for 4 U subrack
6	56	3685.783	3685.785
9	84	3685.784	3685.786

+ Also required

Collar screws and plastic collars,
packs of 100 sets, order no. 3658.160,
see page 202

Trim frame for horizontal mounting kit, vented

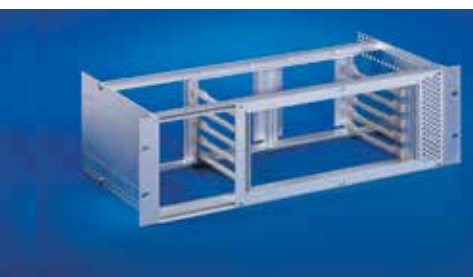

To conceal the front sections of the
horizontal mounting kit.

Material

Aluminium

Surface finish

Anodised,
clear-chromated (EMC version)

Supply includes

EMC accessories
(with EMC version).

U horizontal	HP	Order No.	
		for 3 U subrack	for 4 U subrack
6	63	3685.787	3685.788

+ Also required

Collar screws and plastic collars,
packs of 100 sets, order no. 3658.160,
see page 202

EMC version

U horizontal	HP	Order No.	
		for 3 U subrack	for 4 U subrack
6	63	3685.291	3685.292

+ Also required

Centering screws,
packs of 100, order no. 3687.050,
see page 203

COMPONENTS AND ACCESSORIES

TOP-HAT RAIL MOUNTING

Fixing for HeiPac top-hat rail version 1

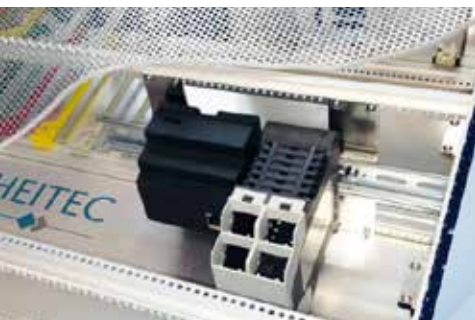

NEW

Rail holder to mount a top-hat rail on the horizontal subrack rails

Material

Rail holder: Aluminium, not surface-coated
 Top-hat rail: steel, zinc-plated

Supply includes

2 rail holders
 1 top-hat rail, perforated
 Assembly parts

Height	HS	L1	L2	Packs of	Order No.
3 U	35	100	7.5	1	9918814
3 U	35	200	7.5	1	9918815
3 U	35	300	7.5	1	9918816
3 U	35	400	7.5	1	9918817
3 U	35	100	15	1	9918818
3 U	35	200	15	1	9918819
3 U	35	300	15	1	9918820
3 U	35	400	15	1	9918821

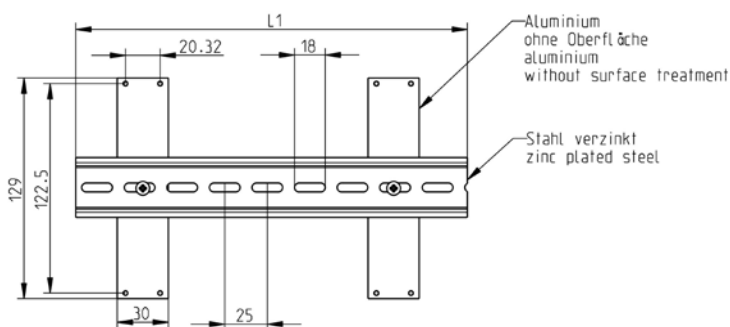

Fixing for HeiPac top-hat rail version 2



NEW

Fixing bracket to mount a top-hat rail on the subrack side panel

Material

Fixing bracket: steel plate, zinc-plated

Supply includes

2 fixing brackets
 Assembly parts

Packs of	Order No.
1 set	3634.770

+ Also required

Top-hat rail, packs of 1, see page 153

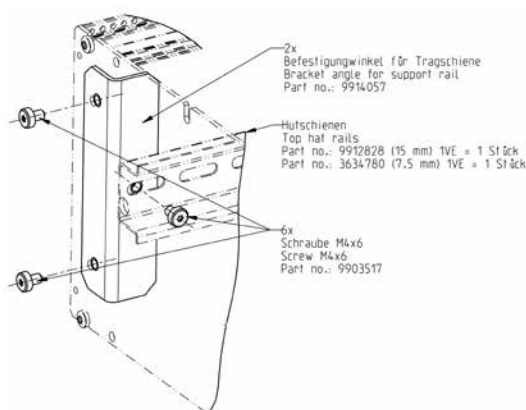

Top-hat rail adapter



NEW

Top-hat rail adapter to directly mount a component or device on a top-hat rail

Material

Extruded aluminium section

Packs of	Order No.
1	3687.739

+ Also required

Assembly screws ,packs of 100
Order no. 3606.550
see page 202

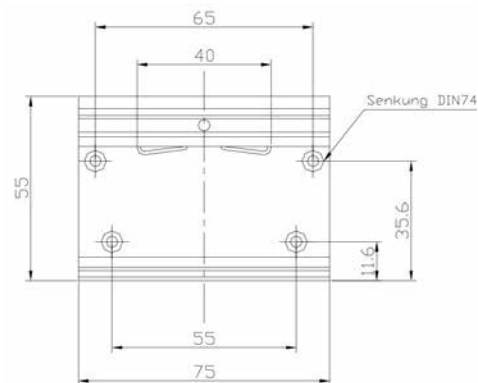

Top-hat rail



NEW

Material

Steel

Surface finish

Zinc-plated

For Width	Dimensions mm	Packs of	Order No.
84 HP	35 x 7.5 x 425	1	3634.780
84 HP	35 x 15 x 425	1	9912.828

COMPONENTS AND ACCESSORIES

GUIDE RAILS

Guide rails, plastic

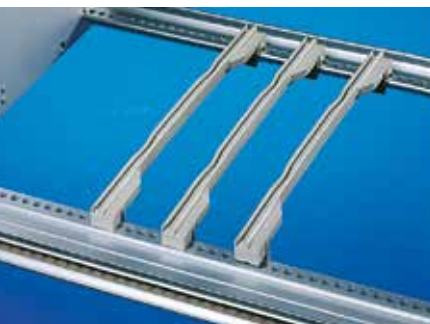

For 160, 220 and 280 mm PCBs up to 2 mm nominal thickness.

2 versions are available:

- Snap-in fastening and screw-fastening
- Snap-in fastening

Material

Polycarbonate
Base material to UL 94-V0

For PCB depth mm	Packs of	Order No.	
		Snap-in fastening/ screw-fastening ¹⁾	Snap-in fastening
100	1	-	3688.005
160	1	3684.657	3684.654
220	1	3684.658	3684.655
280	1	3684.659	3684.656

+ Also required

¹⁾ Assembly screws
packs of 100, order no. 3654.360
see page 202

Guide rails for contact spring fitting, plastic

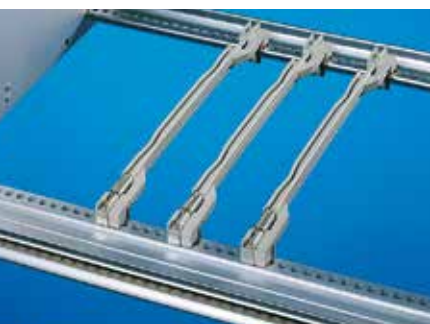

For 160, 220 and 280 mm PCBs up to 2 mm nominal thickness. By installing contact springs, an electrical connection can be made between the PCB and the assembly.

Material

Polycarbonate
Base material to UL 94-V0

For PCB depth mm	Packs of	Order No.
160	1	3684.660
220	1	3684.661
280	1	3684.662

+ Also required

Contact springs, order no. 3687.726
see page 154

Contact springs



For electrical connection between the PCB and the subrack, or to discharge static charges from the PCB.

Suitable for installation in "guide rails for contact spring fitting" and "end pieces for guide rails".

Packs of	Order No.
10	3687.726

Guide rails, Aluminium

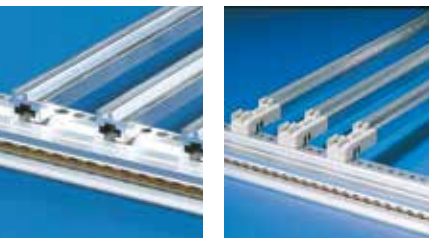

1

2

For high loads. Suitable for nominal PCB thicknesses of 1.6 mm. A distinction is made between guide rails for and without end pieces.

The guide rails without end pieces are screwfastened directly into the horizontal rail.

Material

Aluminium

For PCB depth mm	Packs of	Order No.	
		1 Without end piece ¹⁾	2 For end pieces
160	1	3687.526	3684.663
220	1	3687.527	3684.664
280	1	3687.528	3684.665
1000	1	3684.666	-

+ Also required

- ¹⁾ Screw M2.5 x 6, packs of 100, order no. 3654.340, see page 202
- ¹⁾ Nut M2.5, packs of 100, order no. 3654.370, see page 202
- ¹⁾ Retaining cage M2.5, packs of 100, order no. 9901.417, see page 202

End pieces for guide rails, aluminium



Mounting contact springs ensures an electrical connection between the PCB and the subrack.

Material

Polycarbonate
Base material UL 94-V1

	Packs of	Order No.
End piece, front	1	3684.668
End piece, rear	1	3685.759

+ Also required

Contact springs, order no. 3687.726
see page 154

Keyable guide rails 4 HP, plastic



Guide rails 4 HP, keyable, to IEEE 1101.10.

- For 1.6 – 2.0 mm nominal thickness
- Chambers for the installation of keys
- Option of installing ESD contacts to discharge static charges
- Narrow design for maximum air flow
- Various colour variants to identify the slots:
 - Red for system slot
 - Green for power supply
 - Yellow and grey for board-type plug-in units

- 1** ESD contact for guide rails
- 2** ESD contact for front panel
- 3** Keys

Material

Polycarbonate
Base material to UL 94-V0

Note

Only for use in conjunction with type IV, IVs, VII injector/extractor handles.

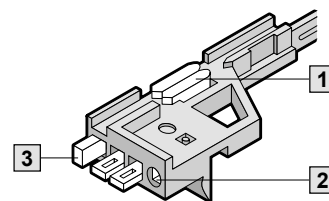

For PCB depth mm	Packs of	Order No.			
		Grey	Red	Green	Yellow
160	10	3685.257	-	-	-
220	10	3685.258	-	-	-
280	10	3685.259	-	-	-
160	1	3684.669	3686.063	3688.055	3689.089
220	1	3684.953	9902.240	-	3689.091
280	1	3684.954	-	-	3689.093

+ Accessories

Keys, see page 159

ESD contact, see page 159

Extractor handles type IV, IVs, VII, see page 168 ff.

COMPONENTS AND ACCESSORIES

GUIDE RAILS

Keyable guide rails with 1/2 HP offset



Guide rails with 1/2 HP offset for use in telecom applications. This allows PCBs to be populated on both sides. Green guide rails with offset are prescribed in the CompactPCI specification (PICMG 2.11) for the installation of power supply units.

- For 1.6 – 2.0 mm PCB thickness
- 4 HP x 160/220 mm
- Narrow design for maximum air flow
- Chambers for the installation of keys
- Option of installing ESD contacts to discharge static charges

Material

Polycarbonate
Base material to UL 94-V0

Note

Only suitable for use in conjunction with extractor handles type IV, IVs, VII with 1/2 HP offset.

For PCB depth mm	Packs of	Colour	Order No.
160	1	Grey	3686.137
	1	Yellow	3689.090
	1	Green	3687.832
220	1	Grey	3686.136
	1	Yellow	3689.092

+ Accessories

Keys
see page 159
ESD contact
see page 159
Extractor handles Type IVs, VII with 1/2 HP offset
see page 169

Keyable guide rails for rear I/O assemblies



Guide rails 4 HP, keyable to IEEE 1101.10 Prepared to accommodate a ground contact for assembly of a plug-type connection.

- For 1.6 – 2.0 mm nominal thickness
- For 80 mm deep PCBs
- Chambers for the installation of keys
- Option of installing ESD contacts to discharge static charges
- Narrow design for maximum air flow
- For CPCI or VME applications

Material

Polycarbonate
Base material to UL 94-V0

Note

- Only for use in conjunction with type IV, IVs, VII injector/extractor handles.
- Not suitable for horizontal rails with double screw-fastening

Colour	For PCB depth mm	Packs of	Order No.	
			Top	Bottom
Grey	80	1	3687.936	3687.937
Yellow	80	1	3689.097	3689.098

+ Accessories

Keys
see page 159
ESD contact
see page 159
Extractor handles type IV, IVs, VII
see page 168 ff.

Ground contact



Ensures a plug-in ground connection. UL-approved.

Material

Die-cast zinc

Supply includes

Grounding bush and contact spring

Note

Only suitable for use in conjunction with keyable guide rails for I/O assemblies.

	Order No.	
	1 set	50 sets
Grounding bush and contact spring	3689.036	3687.951

+ Also required

Assembly screws 3.5 x 12 mm, packs of 50, order no. 3684.109, see page 202



Keyable guide rails, aluminium, three-part



Keyable guide rails with aluminium centre part, for high mechanical loads. Suitable for 1.6 – 2.0 mm PCB thickness.

The guide rails are compiled from the following individual components:

- 1** 2 end pieces
- 2** 1 aluminium centre part
- 3** Insulating centre part(s)



1 End pieces

For three-part guide rails

For 1.6 – 2.0 mm PCB thickness

Material

Polycarbonate
Base material to UL 94-V0

Note

A front and a rear end piece is required for each guide rail.

	Packs of	Order No.
	10 pairs	3685.265
Front end piece	1	3685.790
Rear end piece	1	3684.670



2 Aluminium centre part

For three-part guide rails

For 1.6 – 2.0 mm PCB thickness

Material

Aluminium, unplated

For PCB depth mm	Order No.	
	Packs of 1	Packs of 10
220	3684.673	3685.260
280	3684.674	3685.261
340	3684.675	3685.262
400	3684.676	3685.263
1000	3684.672	-



3 Insulated centre part

For three-part guide rails

The insulating centre part is pushed onto the aluminium centre piece. Length: 60 mm

Material

Plastic, self-extinguishing to UL 94-V0

Packs of	Order No.
1	3684.677
10	3685.264

For PCB depth mm	Number of insulating strips required
220	2
280	3
340	4
400	5

COMPONENTS AND ACCESSORIES

GUIDE RAILS

Guide rails for 4.4" drive modules



Snap-fastening guide rails to accommodate PCBs and assemblies with a height of 4.4" (111.76 mm)

Material

Polycarbonate
Base material to UL 94-V0

Colour

RAL 7032 (Grey)

For PCB depth mm	Packs of	Order No.
160	1	9919.834

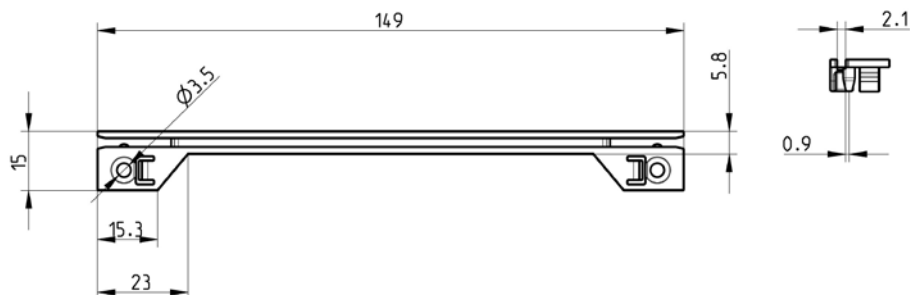

Guide rails for box type plug-in units

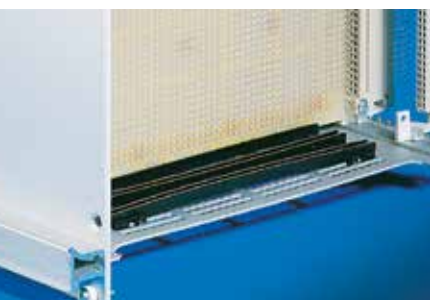

For PCB thickness 1.6 mm.
For insertion into covers with vent slots
(from 12 HP)
see page 184

Material

Noryl

For PCB depth mm	Packs of	Order No.
160	10	3606.140
220	10	3606.200

Air block panel for slots



To conceal unused slots and prevent unwanted airflow. The air block panel simply snaps into position on the guide rails.

Material

Polycarbonate
Self-extinguishing to UL 94-V0

Colour

Blue

Note

Can only be used in conjunction with keyable guide rails 4 HP/160 mm
Not suitable for use in conjunction with guide rails with 1/2 HP offset.

For keyable guide rail mm	Packs of	Order No.
160	1	3687.924

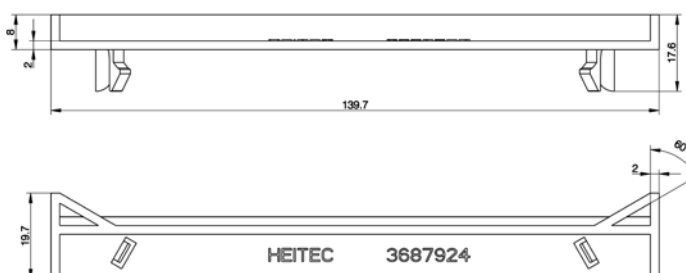

ESD contacts

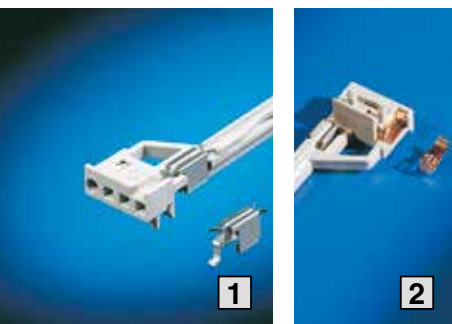
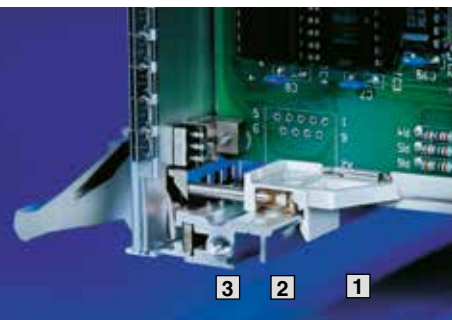

For installation in keyable guide rails

To discharge static charges

- 1 ESD contact in the guide rail**
For permanent direct discharge from the PCB.
- 2 ESD contact for front panel**
To discharge static charges in conjunction with the ESD pin. For insertion into the end piece of the guide rail.

3 ESD pin

4 Keys

Material

- 1** Stainless steel
- 2** Tin bronze, tin-plated

Note

Only for use in conjunction with extractor handle with ESD pin (type IV, IVs, VII), see page 168 ff.

ESD clip for	Packs of	Order No.
Guide rail	50	3684.204
Front panel	50	3684.205

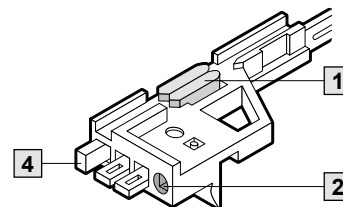

Keys



Keys are used for coding of board-type plug-in units and prevent the use of assemblies in incorrect slots. The keys are inserted into the chambers of the keyable guide rails and the injector/extractor handles, types IV, IVs and VII (4 positions are possible). This produces 64 keying combinations per guide rail. When keying the top and bottom guide rail, 4096 potential combinations are possible.

Standards

IEEE 1101.10, IEC 60 297-5-104

Material

Plastic
PBTP
Base material to UL 94-V0

Colour	Packs of	Order No.
Grey	100	3684.325
Red	100	3684.326

+ Accessories

Keying tool
see page 160

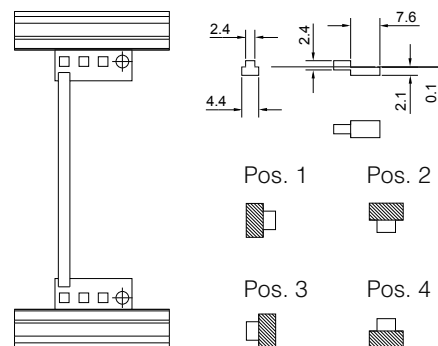
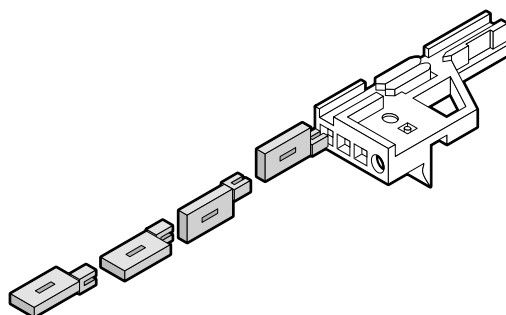

COMPONENTS AND ACCESSORIES

ACCESSORIES FOR KEYABLE GUIDE RAILS

PCB ejector/retainer

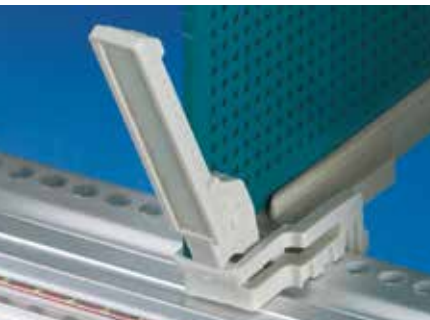

The two-piece PCB ejector is used for securing and extracting PCBs without front panels. The base section may also be used separately for board retention only.

Material

Polycarbonate
Base material to UL 94-V0

Note

Only suitable for guide rails 2 HP

	Packs of	Order No.
1 PCB ejector/retainer	10	3687.014
2 PCB retainer	10	3687.052

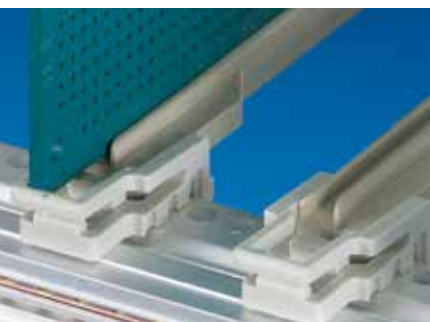

Keying tool



For simple assembly of keys. Up to 3 coding keys may be fitted simultaneously. An integral alignment pin makes positioning easier.

Material

Polycarbonate
Base material to UL 94-V0

Packs of	Order No.
1	3687.956

Covers version 1



For all HeiPac Vario subracks

To cover the overall-subrack depth (EMC application) or as connector protection

- Flat design for top and bottom
- Optionally solid or perforated
- For mounting on the subrack side panel with the aid of mounting blocks

Material

1.0 mm aluminium, unplated, hole diameter 4 mm in perforated version.

Each set includes

2 cover plates
8 mounting blocks 28.5 mm
24 assembly screws

Individual unit includes

1 cover plate

Note

For EMC applications, additional mounting blocks must be fitted across the entire subrack depth.

HP	For side panel depth (T) mm	Cover depth (d1) mm	Order No.			
			Single piece ¹⁾		Set	
			Perforated	Solid	Perforated	Solid
21	225	192	3687.618	3687.620	-	-
21	285	252	3687.619	3687.621	-	-
42	175	142	3684.957	3687.626	-	-
42	225	192	3687.623	3687.627	-	-
42	245	212	3684.958	3687.628	-	-
42	285	252	3685.642	3687.629	-	-
84	175	142	3684.681	3684.680	3685.245	3685.250
84	225	192	3684.694	3684.683	-	-
84	235	202	3685.851	3685.813	-	-
84	245	212	3684.695	3684.684	3685.246	3685.251
84	285	252	3684.696	3684.685	-	-
84	295	262	3685.855	3685.814	-	-
84	305	272	3685.852	3684.686	3685.247	3685.252
84	345	312	3684.698	3684.687	-	-
84	365	332	3685.853	3684.688	3685.248	3685.253
84	405	372	3684.700	3684.689	3685.249	3685.254
84	465	432	3684.701	3684.691	-	-
84	525	492	3684.702	3684.692	-	-
84	585	552	3684.703	3684.693	-	-

+ Also required

¹⁾ Mounting blocks, see page 148

¹⁾ EMC gaskets for cover plates, see page 147

¹⁾ Assembly screws, packs of 100, order no. 3684.233, see page 202

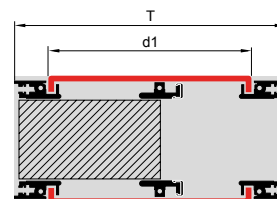
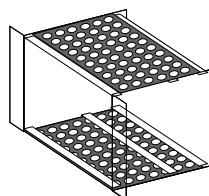

COMPONENTS AND ACCESSORIES COVERS

Covers version 2

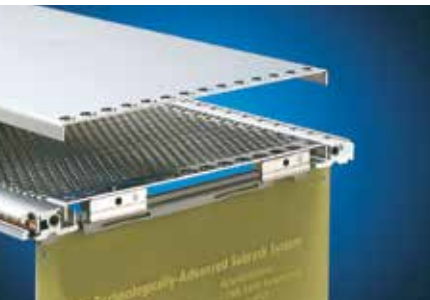

For all HeiPac Vario subracks

To cover the PCB depth

- Flat design for top and bottom
- Optionally solid or perforated
- For mounting on the subrack side panel with the aid of mounting blocks

Material

1.0 mm aluminium, unplated, hole diameter 4 mm in perforated version

Each set includes

2 cover plates
8 mounting blocks 28.5 mm
24 assembly screws

Individual unit includes:

1 cover plates

			Order No.			
			Single piece ¹⁾		Set	
HP	For PCB depth (d2) mm	Cover depth (d1) mm	Perforated	Solid	Perforated	Solid
21	160	142	3687.630	3687.634	-	-
21	220	202	3687.631	3687.635	-	-
42	160	142	3684.957	3687.626	-	-
42	220	202	3687.633	3687.637	-	-
42	280	262	3687.638	3687.639	-	-
84	160	142	3684.681	3684.680	3685.245	3685.250
84	220	202	3685.851	3685.813	-	-
84	280	262	3685.855	3685.814	-	-
84	340	322	3685.856	-	-	-
84	400	382	3685.857	-	-	-

+ Also required

¹⁾ Mounting blocks, see page 148

¹⁾ Assembly screws, packs of 100, order no. 3684.233, see page 202

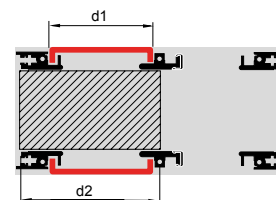
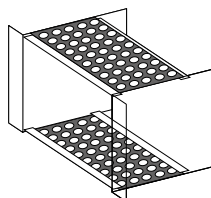

Covers version 3



For all HeiPac Vario subracks

To cover the overall subrack depth (EMC application)

- Cover with 1 U edge fold (item 1), to conceal the 1 U area in the subrack
- A version 1 fl at cover (item 2) is additionally required
- Optionally perforated or solid on the front
- Suitable for subracks 4 U (3 + 1), 7 U (6 + 1)
- For mounting on the subrack side panel with the aid of mounting blocks

Material

1.0 mm aluminium, unplated, hole diameter 4 mm in perforated version.

Note

For EMC applications, mounting blocks must be fitted across the entire subrack depth.

			Order No.	
HP	For side panel depth (T) mm	Cover depth (d3) mm	Perforated	Solid
84	285	270	3684.720	3684.714
84	345	330	3684.721	3684.715
84	405	390	3684.722	3684.716
84	465	450	3684.723	3684.717
84	525	510	3684.724	3684.718
84	585	570	3684.725	3684.719

+ Also required

Mounting blocks, see page 148

EMC gaskets for covers, see page 147

Assembly screws, packs of 100, order no. 3684.233, see page 202

Cover, version 1, see page 161

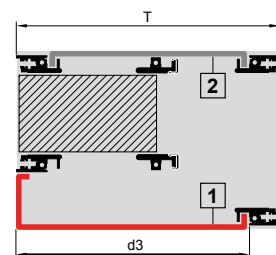
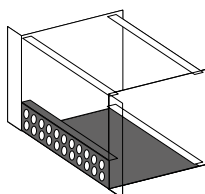

Covers version 4

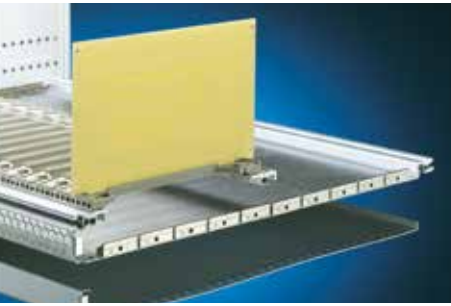

For all HeiPac Vario subracks

To cover the overall subrack depth (EMC application)

- Cover top/bottom with ½ U edge fold to cover the ½ U section in the subrack
- Optionally perforated or solid on the front
- Suitable for subracks 4 U (3 + 2 x ½), 7 U (6 + 2 x ½)
- For mounting on the subrack side panel with the aid of mounting blocks.

Material

1.0 mm aluminium, unplated, hole diameter 4 mm in perforated version.

Note

For EMC applications, mounting blocks must be fitted across the entire subrack depth.

HP	For side panel depth (T) mm	Cover depth (d3) mm	Order No.	
			Perforated	Solid
84	285	270	3684.732	3684.726
84	345	330	3684.733	3684.727
84	405	390	3684.734	3684.728
84	465	450	3684.735	3684.729
84	525	510	3684.736	3684.730
84	585	570	3684.737	3684.731

+ Also required

Mounting blocks, see page 148

EMC gaskets for covers, see page 147

Assembly screws, packs of 100, order no. 3684.233, see page 202

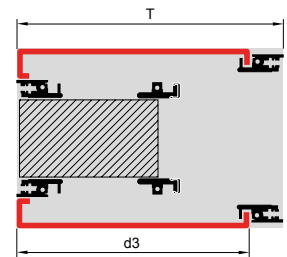
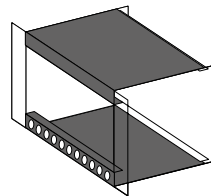

Covers version 5



For all HeiPac Vario subracks

To cover the overall subrack depth or PCB depth. (EMC application)

Simple assembly:

- Side edge fold with half shears facilitates fast assembly (without mounting blocks) by simply snap-fastening
- Side notches for fitting horizontal rails in 160, 220 or 280 mm depth
- Optionally solid or perforated

Material

1.0 mm aluminium, unplated, hole diameter 4 mm in perforated version.

Supply includes

2 gaskets

HP	Position of side notches for horizontal rails mm	For side panel depth mm	Order No.	
			Perforated	Solid
21	160	175/185	3687.624	-
21	160/220	235	3687.692	-
42	160	175/185	3687.625	-
42	160/220	235	3687.677	-
42	160	245	3687.640	-
84	160	175/185	3687.641	3687.647
84	160	245	3687.642	3687.648
84	160/220	235	3687.643	3687.649
84	160/220	285	3687.644	3687.650
84	160/220	305	3687.645	3687.651
84	160/220/280	345	3687.646	3687.652

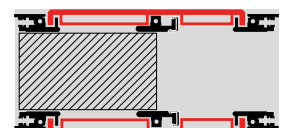
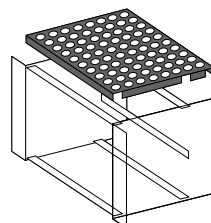

COMPONENTS AND ACCESSORIES COVERS

Covers for HeiPac EASY



- Perforated or solid
- Optionally with screwed fastening clips on the side panels for additional support

Material

Aluminium

Supply includes

2 cover plates

Cover plates

version 1 (slide-in)

The covers are simply slid into the front and rear horizontal rails for mounting backplanes/connectors.

version 2 (slide-in/screw-in)

For mounting additional rear horizontal rails on the rear panels. The horizontal rails for backplane/connector assembly are top-mounted. The covers are slid in the front horizontal rails and screwed in the rear horizontal rails for rear panel mounting.



Version 1

HP	For side panel depth mm	Order No.	
		Perforated	Solid
84	175	3634.685	3634.675
84	235	3634.690	3634.680

Version 2

HP	For side panel depth mm	Order No.	
		Perforated ¹⁾	Solid ¹⁾
84	175	3634.650	3634.625
84	235	3634.655	3634.630
84	295	3634.660	3634.635
84	355	3634.665	3634.640
84	415	3634.670	3634.645

+ Also required

¹⁾ assembly screws, packs of 100
order no. 3684.233
see page 202

+ Accessories

Fastening clips

Fastening clips

Packs of	Order No.
50	3634.450

Assembly screws for fastening clips

Packs of	Order No.
100	9921.879

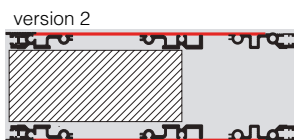
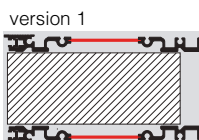

Covers for HeiPac Vario ECO



To cover the overall subrack depth

- Perforated or solid
- The covers are slid into the horizontal rails
- Optionally with screwed fastening clips for additional support

Material

Sheet steel

Surface finish

Zinc-plated

Supply includes

1 cover plate



HP	For side panel depth mm	Order No.	
		Perforated	Solid
84	175	3688.105	3688.107
84	235	3688.106	3688.108

+ Accessories

Fastening clips

Packs of	Order No.
1	3688.109

Assembly screw

Packs of	Order No.
100	9921.879

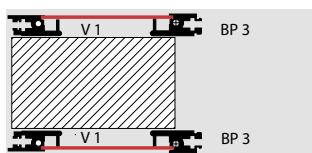

1 for backplane

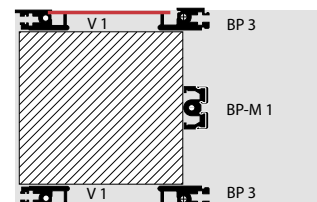

2 for backplane

Flat front panels with extractor handle



With type I or II extractor handle
Complete modular systems

Material

Front panel: 2,5 mm Aluminium anodised
Handle: Plastic black

Supply includes

1 front panel
2 handles (1 with 3 U)
1 set of assembly parts
1 PCB holder (for 3 U)

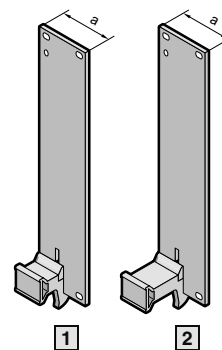

U	HP	a mm	Order No.	
			1 Type I.	2 Type II
3	4	20.0	3684.330	3684.358
3	5	25.1	3684.331	3684.359
3	6	30.2	3684.332	3684.360
3	7	35.3	3684.333	3684.361
3	8	40.3	3684.334	3684.362
3	10	50.5	3684.335	3684.363
3	12	60.7	3684.336	3684.364
6	4	20.0	3684.337	3684.365
6	5	25.1	3684.338	3684.366
6	6	30.2	3684.339	3684.367
6	7	35.2	3684.340	3684.368
6	8	40.3	3684.341	3684.369
6	10	50.5	3684.342	3684.370
6	12	60.7	3684.343	3684.371
9	4	20.0	-	3684.372
9	8	40.3	-	3684.373

Front panels with type I, II or IV, IVs, VII extractor handles

3 U

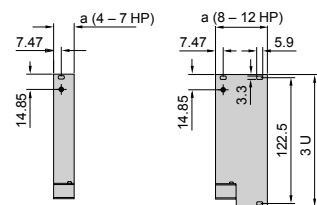

6 U

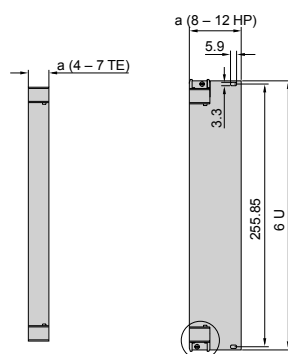

9 U

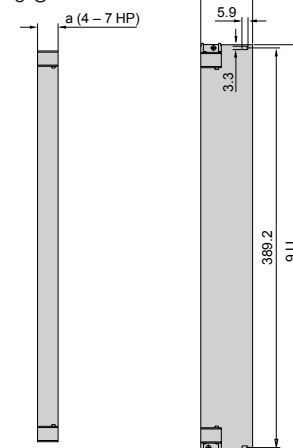

Extractor handles

Type I

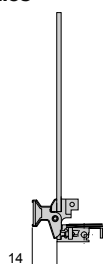

Type II

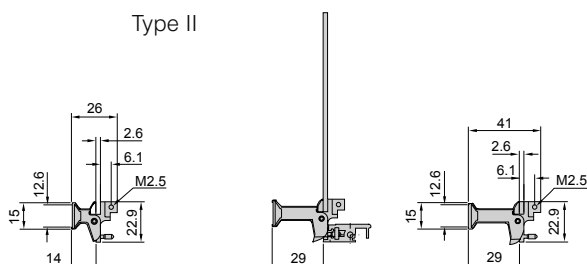

COMPONENTS AND ACCESSORIES

FRONT PANELS AND HANDLES

U-channel front panels with injector/extractor handle



With type I, II extractor handle or type IV injector/extractor handle
Complete modular systems

Material

front panel: extruded aluminium section
clear-chromated
Handle: plastic
black

Supply includes

1 front panel
2 handles (1 with 3 U)
1 EMC gasket, vertical, version 1
1 set of assembly parts
1 PCB holder (for 3 U)

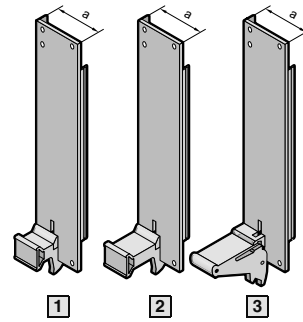

Detailed drawing
see page 168 ff.



U	HP	a mm	Order No.		
			1 Type I.	2 Type II	3 Type IV ¹⁾
3	4	20.0	3684.344	3684.374	3684.413
3	5	25.1	3684.345	3684.375	3684.414
3	6	30.2	3684.346	3684.376	3684.415
3	7	35.3	3684.347	3684.377	3684.416
3	8	40.3	3684.348	3684.378	3684.417
3	10	50.5	3684.349	3684.379	3684.418
3	12	60.7	3684.350	3684.380	3684.419
6	4	20.0	3684.351	3684.381	3684.420
6	5	25.1	3684.352	3684.382	3684.421
6	6	30.2	3684.353	3684.383	3684.422
6	7	35.2	3684.354	3684.384	3684.423
6	8	40.3	3684.355	3684.385	3684.424
6	10	50.5	3684.356	3684.386	3684.425
6	12	60.7	3684.357	3684.387	3684.426
9	4	20.0	-	3684.388	3684.427
9	5	25.1	-	-	3684.428
9	6	30.2	-	-	3684.429
9	7	35.3	-	-	3684.430
9	8	40.3	-	3684.389	3684.431
9	10	50.5	-	-	3684.432
9	12	60.7	-	-	3684.433

¹⁾Can only be inserted in conjunction with front horizontal rails, with 10 mm roof (Vario V-Ext. 1), see page 133

Front panels for type I, II, IV, IVs or VII handles

3 U

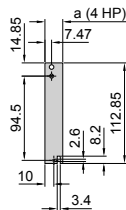
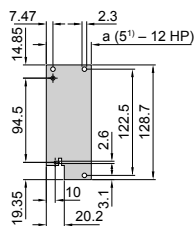

6 U

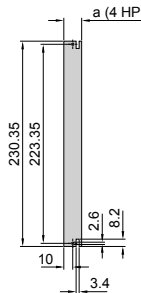
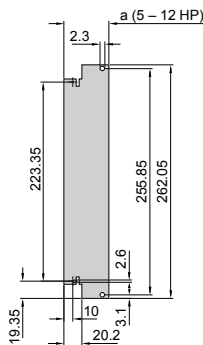

9 U

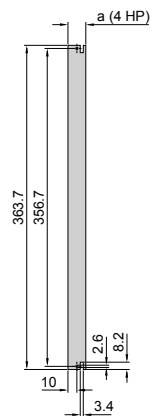
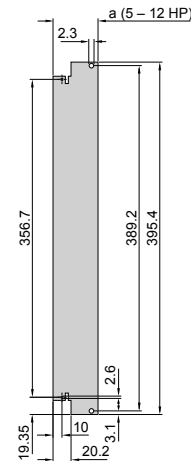

¹⁾ 2.3 mm drilled hole not contained in versions 5 – 7 HP.

Flat front panels for handles

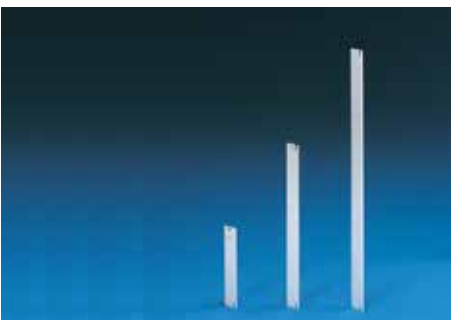

For type I, II extractor handle or type IV, IVs or VII injector/extractor handle

Material

2,5 mm Aluminium
Anodised

Detailed drawing front panel
see page 165

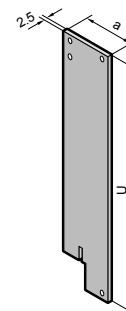

+ Also required

From front panel widths of 4 HP (at 3 U) and 8 HP (at 6 U):
Collar screws and plastic collars, packs of 100 sets,
order no. 3658.160, see page 202
For 3 U front panels:
PCB holder set, see page 177

HP	a mm	Order No.		
		3 U	6 U	9 U
4	20.0	3685.500	3685.508	3685.516
5	25.1	3685.501	3685.509	3685.517
6	30.2	3685.502	3685.510	3685.518
7	35.3	3685.503	3685.511	3685.519
8	40.3	3685.504	3685.512	3685.520
10	50.5	3685.505	3685.513	3685.521
12	60.7	3685.506	3685.514	3685.522

U-channel front panels for handles

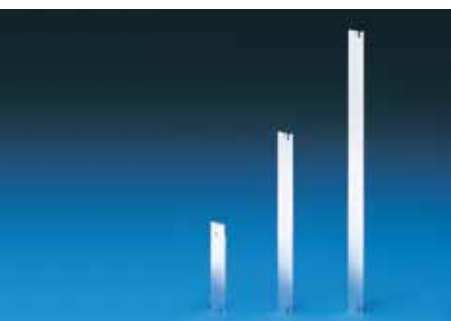

For type I, II extractor handle or type IV, IVs or VII injector/extractor handle

Material

2,5 mm extruded aluminium section
clear-chromated

Detailed drawing front panel
see page 166

EMC

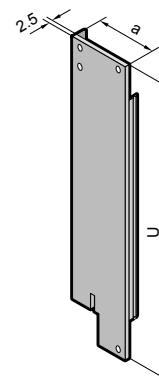

+ Also required

From front panel width 4 HP (for 3 U) and 8 HP (for 6 U):
Slotted centering screws, packs of 100,
order no. 3687.050, see page 203
Posidrive centering screws, packs of 100,
order no. 3687.051, see page 203
EMC gaskets, see page 146
For 3 U front panels:
PCB holder set, see page 177

HP	a mm	Order No.		
		3 U	6 U	9 U
4	20.0	3685.524	3685.532	3685.540
5	25.1	3685.525	3685.533	3685.541
6	30.2	3685.526	3685.534	3685.542
7	35.3	3685.527	3685.535	3685.543
8	40.3	3685.528	3685.536	3685.544
10	50.5	3685.529	3685.537	3685.545
12	60.7	3685.530	3685.538	3685.546

COMPONENTS AND ACCESSORIES

FRONT PANELS AND HANDLES

Extractor handle type I and type II



- Suitable for flat front panels/U-channel front panels
- With removal function
- May be used in combination with horizontal rails with 10 mm extension.

Supply includes

Assembly parts

Note

With 3 U, only one extractor handle is required.

1 Type I extractor handle, 15 mm

Colour	Packs of	Order No.
Grey	1	3685.587
Black	1	3685.589

2 Type II extractor handle, 30 mm

Colour	Packs of	Order No.
Grey	1	3685.588
Black	1	3685.590

+ Accessories

Identification strips for extractor handles, see page 169

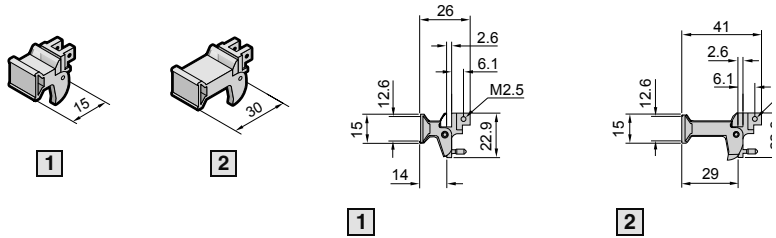

Injector/extractor handle type IV

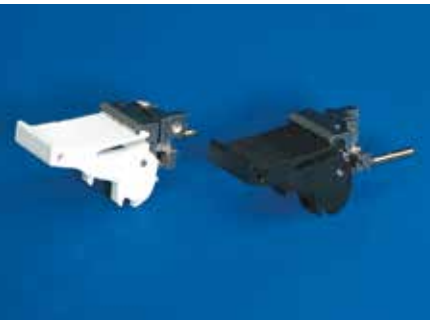

Handles with micro-switch

For inserting and removing connectors with a large number of pins.

- Insertion/removal function
- Integral microswitch for "live insertion" applications
- Self-activation of the micro-switch during insertion/removal
- ESD pin to dissipate static charges before contacting the connectors and for precise positioning of the board type plug-in unit
- Keyable
- Integral PCB attachment
- Self-locking
- Bayable

Handle without micro-switch

Description see above.
Micro-switch may be retrofitted.

Supply includes

1 handle without or with micro-switch, assembly parts

Note

- Insertion only when used with front horizontal rails, with 10 mm extension see page 133 ff.
- With 3 U front panels, only one extractor handle is required

Handles with micro-switch

Colour	Installation	Packs of	Order No.
Grey	Top	1	3686.905
Grey	Bottom	1	3686.904
Black	Top	1	3686.907
Black	Bottom	1	3686.906

Handle without micro-switch

Colour	Installation	Packs of	Order No.
Grey	Top	1	3686.901
Grey	Bottom	1	3686.900
Black	Top	1	3686.903
Black	Bottom	1	3686.902

+ Accessories

Keys, see page 159
Keyable guide rails, see page 156
Micro-switches, see page 171
Connector pin for baying, see page 170



Injector/extractor handle type IV



8 HP, bayed
Suitable for two front panels 4 HP that must be connected to another mechanically.

Supply includes

2 bayed handles
fully assembled

Colour	Installation	Packs of	Order No.
Black	Bottom	1	3686.908
Black	Top	1	3686.909

+ Accessories

Connector pin for baying,
see page 170

Identification strips for extractor handles



For type I, II extractor handle and type IV injector/extractor handle
Width 4 HP

Packs of	Order No.
100	3684.328

Injector/extractor handle type IVs



With push-button

For inserting and removing connectors with a large number of pins. A metal insert ensures reliable functioning, even at forces of up to 815 N.

- Insertion/removal function
- Push-button for locking and unlocking the board type plug-in unit (cannot be extracted in the locked position)
- Optionally with 1/2 HP offset PCB attachment, e. g. for component mounting on both sides
- Optional integral micro-switch for "live insertion" applications
- ESD pin to dissipate static charges before contacting the connectors and for precise positioning of the board type plug-in unit
 - according to IEEE 1101.1
 - Keyable
 - Integral PCB attachment
 - Bayable

Material

Plastic/metal

Supply includes

Assembly parts

Note

- Insertion only when used with front horizontal rails, with 10 mm extension see page 133 ff.
- With 3 U front panels, only one extractor handle is required.

Handles without offset

Installation	Packs of	Order No.
Top	1	3688.770
Bottom	1	3688.771

Handles with 1/2 HP offset

Installation	Packs of	Order No.
Top	1	3688.772
Bottom	1	3688.773

+ Accessories

Keys,
see page 159
Keyable guide rails with 1/2 HP offset,
see page 156
Micro-switches,
see page 171
Connector pin for baying,
see page 170

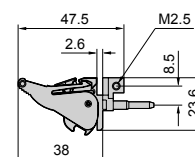

COMPONENTS AND ACCESSORIES

FRONT PANELS AND HANDLES

Connection pin for injector/extractor handles



For injector/extractor handles, types IV, IVs and VII

The connection pin can be used to connect injector/extractor handles, types IV, IVs and VII.

Material

Steel

Packs of	Order No.
20	3685.319

Injector/extractor handle type VII



Plastic

For inserting and removing connectors with a large number of pins. This handle was specifically designed for use in telecom applications.

- Insertion/removal function
- Optionally with 1/2 HP offset PCB attachment, e. g. for component mounting on both sides
- Minimum front space requirements, due to foldup handle
- Optional integral micro-switch for "live insertion" applications
- ESD pin to dissipate static charges prior to making contact with the connectors and for precise positioning of the board type plug-in unit
- Keyable
- Large labelling area on the front

Material

Plastic

Supply includes

Assembly parts

Note

- Insertion only when used with front horizontal rails, with 10 mm extension see page 133 ff.

Handles without off set

Installation	Packs of	Order No.
Top	1	3688.784
Bottom	1	3688.785

Handles with 1/2 HP offs et

Installation	Packs of	Order No.
Top	1	3688.780
Bottom	1	3688.781

+ Accessories

Keys, see page 159
Keyable guide rails with 1/2 HP offset, see page 156
Micro-switches, see page 171
Connector pin for buying, see page 170

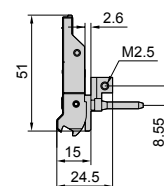

Injector/extractor handle type VII



Metal

For inserting and removing PCBs with a high connector pin-count (up to 815 N). This handle was specifically designed for use in telecom applications.

- Insertion/removal function
- Optionally with 1/2 HP offset PCB attachment, e. g. for component mounting on both sides
- Minimum front space requirements due to foldup handle
- Optional integral micro-switch for "live insertion" applications
- ESD pin to dissipate static charges prior to making contact with the connectors and for precise positioning of the board type plug-in unit
- Keyable
- Metal design for use in aggressive atmospheres

Material

Die-cast zinc

Supply includes

Assembly parts

Note

Insertion only when used with front horizontal rails, with 10 mm extension see page 133 ff.

Handles without off set

Installation	Packs of	Order No.
Top	1	3688.790
Bottom	1	3688.791

Handles with 1/2 HP offs et

Installation	Packs of	Order No.
Top	1	3688.786
Bottom	1	3688.787

+ Accessories

Keys, see page 159
Keyable guide rails with 1/2 HP offset, see page 156
Micro-switches, see page 171
Connector pin for buying, see page 170

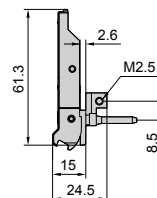

Micro-switch



For "live insertion" applications. Installation in injector/extractor handles, types IV, IVs and VII. May also be retro-fitted.

Technical specifications

Switching load: 50 mA 30 V DC

Service life:
At nominal load: 30.000
mechanical: 50.000

Packs of	Order No.
10	3684.410

+ Accessories

Micro-switch mounting clip, see page 172

Micro-switch

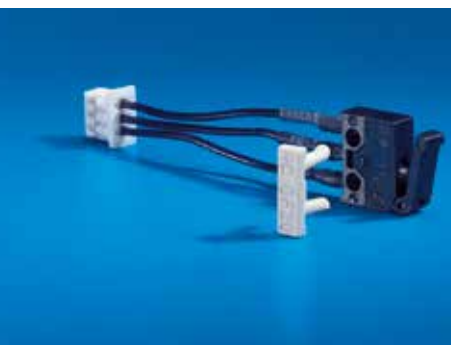

With cable and connector

For "live insertion" applications. Installation in injector/extractor handles, types IV, IVs and VII.

Supply includes

Micro-switch, connector type Molex 51021-0300, mounting clips, 3 cables, 25 mm x #32 AWG, fully assembled

Packs of	Order No.
1 set	3686.536

- 1 Lever not depressed
- 2 Lever hinge
- 3 Lever contact point

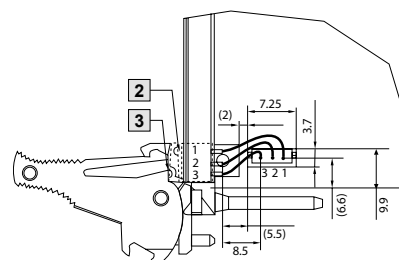
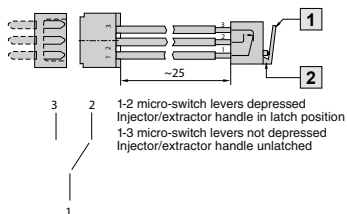

COMPONENTS AND ACCESSORIES

FRONT PANELS AND HANDLES

Micro-switch mounting clip



For mounting micro-switches in handles

Packs of	Order No.
10	3684.411

Plastic covers for PCBs



For mechanical protection of the component side and of the EMC gaskets. Attachment holes as per CPCI or VME-specifications. Optionally available as perforated or solid version.

Material

0,5 mm plastic, transparent, anti-static UL 94-V0, maximum temperature up to 65°C

¹⁾ 0,5 mm plastic, black, anti-static UL 94-V0, maximum temperature up to 120°C

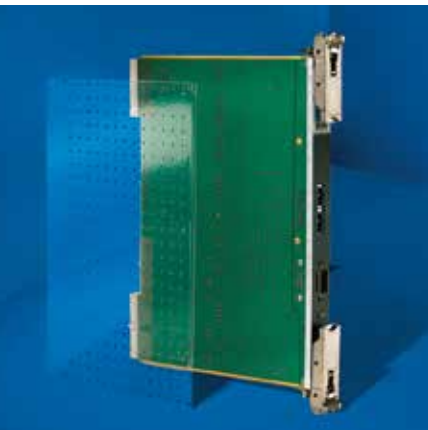
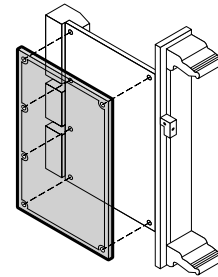

For PCBs	Packs of	Order No.			
		for CPCI		for VME	
		Perforated	Solid	Solid	Solid
3 U x 160 mm	1	3687.932	3686.572	3685.966	3685.626
	5	-	-	-	3685.279
3 U x 220 mm	1	-	-	-	3685.805
	5	-	-	-	3685.266
6 U x 80 mm	1	3687.933	3686.573	3686.037	3686.146
6 U x 160 mm	1	3687.934	3686.574	3685.967	3685.627
	1	9905.574¹⁾	9905.990¹⁾	-	-
	5	-	-	-	3685.280
6 U x 220 mm	1	-	-	-	3685.824
	5	-	-	-	3685.000

+ Also required

Required for mounting the perforated CPCI covers:
 Mounting clips, Packs of = 100
 order no. 3687.955

Front panels for type III extractor handle

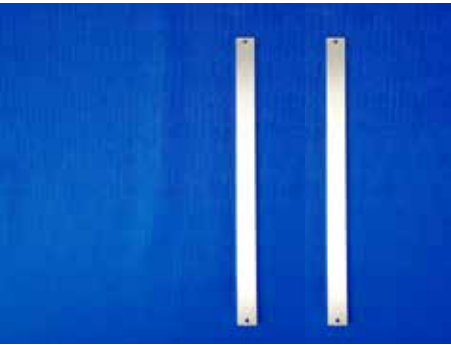

Material

1,0 mm extruded aluminium section

Surface finish

Untreated

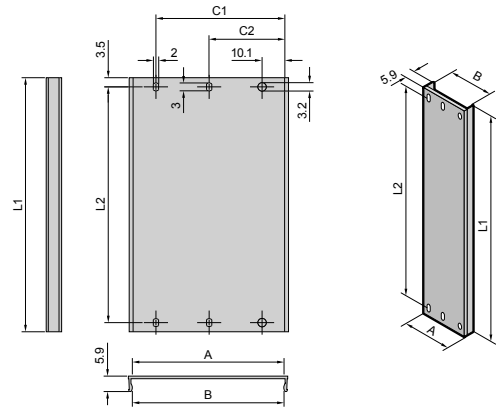

HP	A mm	B mm	C1 mm	C2 mm	Order No.		
					3 U	6 U	9 U
4	15.20	12.20	-	-	3685.548	3685.555	-
5	20.22	17.20	-	-	3685.549	3685.556	3685.562
6	25.28	22.28	-	22.68	3685.550	3685.557	3685.563
7	30.36	27.36	-	25.22	3685.551	3685.558	3685.564
8	40.52	37.52	-	30.30	3685.552	3685.559	3685.566
10	50.68	47.68	40.46	25.22	3685.553	3685.560	3685.567
12	60.84	57.84	50.62	30.30	3685.554	3685.561	3685.568
L1 mm					97.00	230.35	363.70
L2 mm					90.00	223.35	356.70

Type III extractor handle



Material

Fibreglass-reinforced polycarbonate
Base section nickel-plated ABS

Colour

Grey

HP	Packs of	Order No.
3	1	3685.591
4	1	3685.592

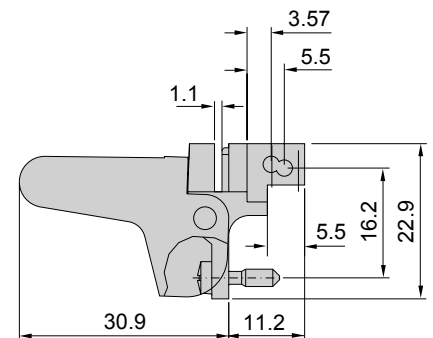
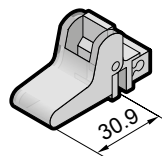

Covers for panel end spaces for type III extractor handle



Material

Fibreglass-reinforced polycarbonate

HP	Width mm	Packs of	Order No.
1	5	1	3687.529
2	10.08	1	3687.530
4	20.24	1	3687.531

COMPONENTS AND ACCESSORIES FRONT PANELS AND HANDLES

Universal holder for front panel support

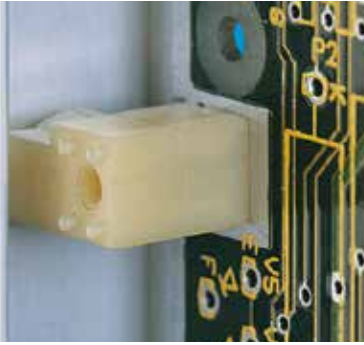

Material
Plastic

HP	Packs of	Order No.
4	1	3687.545

Flat front panels with type V handle and PCB holder



Complete modular systems

Material

Frontplatte: 2,5 mm Aluminium natural-anodised
 Handle: Aluminium natural-anodised
 PCB holder: Polycarbonate

Supply includes

1 front panel
 1 handle (2 with 6 U)
 1 PCB holder (2 with 6 U)
 Assembly parts

HP	a mm	B mm	Order No.	
			3 U H = 128.7	6 U H = 262.05
3	14.9	-	3652.000	3652.200
4	20.0	-	3652.010	3652.210
5	25.1	-	3652.020	3652.220
6	30.1	-	3652.030	3652.230
7	35.2	-	3652.040	3652.240
8	40.3	-	3652.050	3652.250
10	50.5	35.6	3652.060	3652.260
12	60.6	45.7	3652.070	3652.270
14	70.8	55.9	3652.080	-

+ Accessories

Identification strips for handles, see page 177

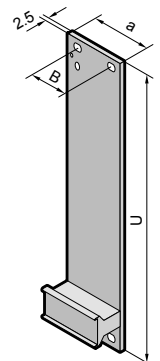
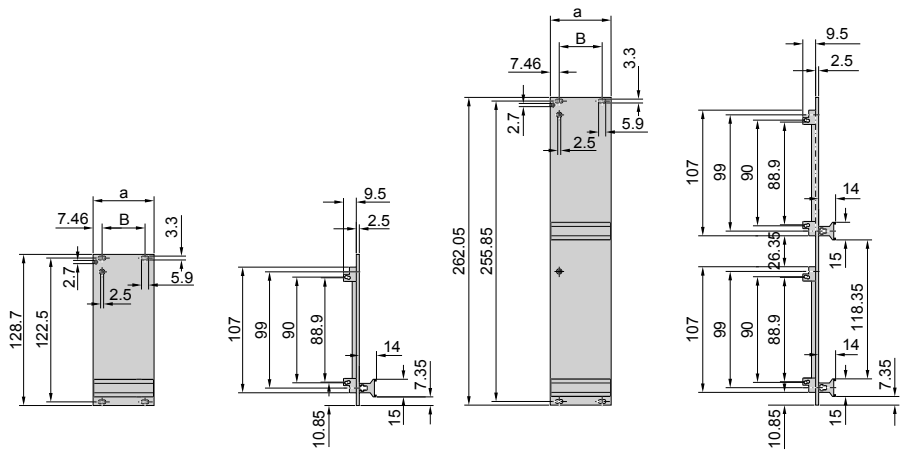

Flat front panels for type V and VI handle

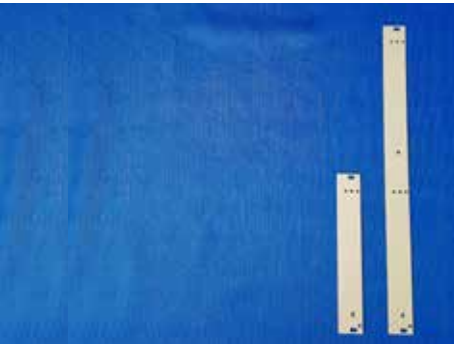

Material

2,5 mm Aluminium, anodised

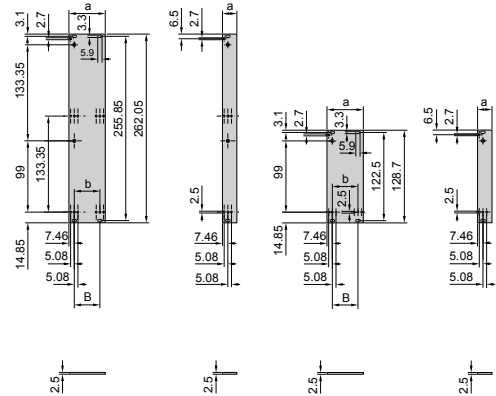

HP	a mm	B mm	b mm	Packs of	Order No.	
					3 U	6 U
3	14.9	-	-	1	3685.569	3685.578
4	20.0	-	-	1	3685.570	3685.579
5	25.1	-	-	1	3685.571	3685.580
6	30.2	-	15.2	1	3685.572	3685.581
7	35.2	-	20.3	1	3685.573	3685.582
8	40.3	-	25.4	1	3685.574	3685.583
10	50.5	35.6	35.6	1	3685.575	3685.584
12	60.6	45.7	45.7	1	3685.576	3685.585
14	70.8	55.9	55.9	1	3685.577	3685.586

+ Also required

Collar screws and plastic collars,
packs of 100 sets, order no. 3658.160,
see page 202

+ Accessories

Handles type V
see page 176
Handles type VI
see page 177

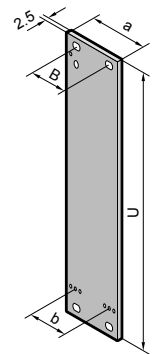

COMPONENTS AND ACCESSORIES FRONT PANELS AND HANDLES

U-channel front panels for type V and VI handle

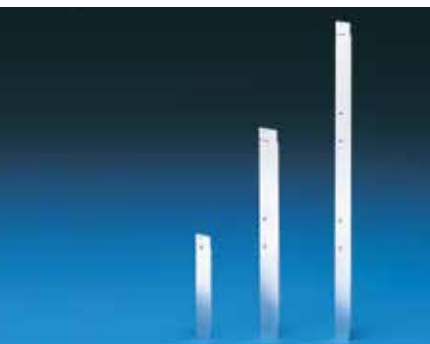

Material
2,5 mm Aluminium, clear-chromated

Supply includes
1 vertical EMC gasket, version 1.



HP	a mm	B mm	Packs of	Order No.	
				3 U	6 U
4	20.0	-	1	3687.655	3687.660
6	30.2	-	1	3687.656	3687.661
8	40.3	-	1	3687.657	3687.662
10	50.5	35.6	1	3687.658	3687.663
12	60.6	45.7	1	3687.659	3687.664

+ Also required

Slotted centering screws,
packs of 100, order no. 3687.050,
see page 203
Cross-head centering screws,
packs of 100, order no. 3687.051
see page 203

+ Accessories

Handles type V
see page 176
Handles type VI
see page 177

Detailed drawing,
see page 175

Type V handle, plastic



Material
Plastic

HP	Colour	Packs of	Order No.
3	Grey	1	3685.490
4	Grey	1	3685.491
8	Grey	1	3685.492
12	Grey	1	3685.493
20	Grey	1	3685.494
3	Black	1	3685.495
4	Black	1	3685.496
8	Black	1	3685.497
12	Black	1	3685.498
20	Black	1	3685.499

+ Also required

Mounting kit,
packs of 1 set, order no. 3687.519
see page 202

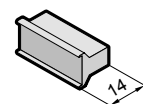

Type V handle, aluminium



Material
Aluminium, anodised

HP	Order No.	HP	Order No.
3	3685.595	12	3685.602
4	3685.596	14	3685.603
5	3685.597	21	3685.761
6	3685.598	28	3685.762
7	3685.599	42	3685.763
8	3685.600	1 m	3685.604
10	3685.601		

+ Also required

Mounting kit
packs of 1 set, order no. 3687.146
(from 6 HP 2 packs required)
see page 203

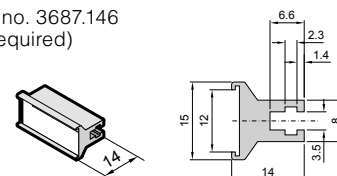

Identification strips for type V handle, aluminium



For individual labelling of the handles

Material

0,5 mm Aluminium, anodised

HP	Packs of	Order No.
3	1	3685.746
4	1	3685.747
5	1	3685.748
6	1	3685.749
7	1	3685.750
8	1	3685.751
10	1	3685.752
12	1	3685.753
14	1	3685.754
21	1	3685.755
28	1	3685.756
42	1	3685.757
1 m	1	3685.758
0.5 m	5	3606.300

Type VI handle



Material

Aluminium, anodised.

HP	Order No.	HP	Order No.
3	3685.605	12	3685.612
4	3685.606	14	3685.613
5	3685.607	21	3685.614
6	3685.608	28	3685.615
7	3685.609	42	3685.616
8	3685.610	84	3685.617
10	3685.611	1 m	3685.618

+ Zusätzlich wird benötigt

Mounting kit
packs of 1 set, order no. 3687.146
(from 6 HP 2 packs required)
see page 203

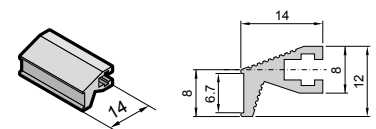

PCB holder kit



For attaching the PCB to front panels with handle types I, II, IV, IVs, VII.

Material

Die-cast

Note

Only required at the top with 3 U front panels

Packs of	Order No.
10	3685.198

+ Also required

For attaching the PCB to the PCB holder:

Pan-head screws
packs of 100, order no. 3654.320
see page 202

For attaching the front panel to the PCB holder:

Oval csk-screws
packs of 100, order no. 3685.282
see page 203

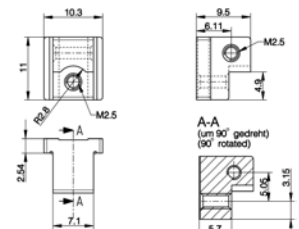

COMPONENTS AND ACCESSORIES

FRONT PANELS AND HANDLES

PCB holder for front panels



For attaching PCBs to front panels (handle type V, VI).

Material

Noryl

Supply includes

Assembly parts

Packs of

10

Order No.

3606.330

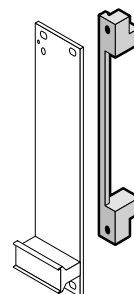

Front panels as filler panel

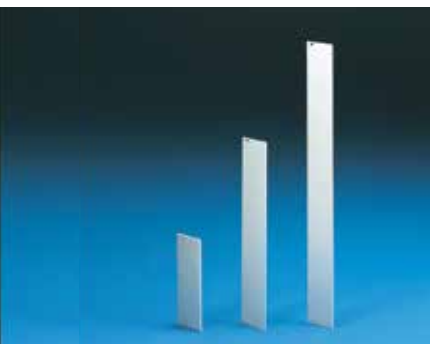

Flat

Material

2,5 mm Aluminium, natural-anodised

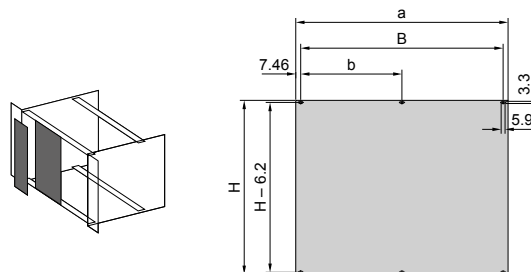

+ Also required

Collar screws and plastic collars, packs of 100 sets, order no. 3658.160, see page 202

HP	a mm	B mm	b mm	Order No.						
				1 U H = 39.8	2 U H = 84.25	3 U H = 128.7	4 U H = 173.15	6 U H = 262.05	7 U H = 306.5	9 U H = 395.4
2	9.8	-	-	-	-	3684.889	-	3684.911	-	3684.738
3	14.9	-	-	-	-	3684.890	-	3684.912	-	-
4	20.0	-	-	-	-	3684.891	-	3684.913	-	3684.739
5	25.1	-	-	-	-	3684.892	-	3684.914	-	-
6	30.2	-	-	-	-	3684.893	-	3684.915	-	-
7	35.2	-	-	-	-	3684.894	-	3684.916	-	-
8	40.3	-	-	-	-	3684.895	-	3684.917	-	3684.740
10	50.5	35.6	-	-	-	3684.896	-	3684.918	-	-
12	60.6	45.7	-	-	-	3684.897	-	3684.919	-	3684.741
14	70.8	55.9	-	-	-	3684.898	-	3684.920	-	-
20	101.3	86.4	-	-	-	3684.899	-	3684.921	-	-
21	106.4	91.4	-	-	3685.350	3684.900	-	3684.922	-	-
24	121.7	106.7	-	-	3685.429	-	-	-	-	-
27	136.8	121.9	-	-	-	3684.901	-	3684.923	-	-
28	141.9	127.0	-	-	-	3684.902	-	3684.924	-	-
40	202.9	188.0	-	-	-	3684.903	-	3684.976	-	3684.977
42	213.0	198.1	-	3684.885	3684.887	3684.904	3684.908	3684.925	3684.928	3684.742
60	304.5	289.6	-	-	-	3684.905	-	-	-	-
63	319.7	304.8	152.4	-	-	3684.906	3684.909	3684.926	3684.929	-
84	426.4	411.5	203.2	3684.886	3684.888	3684.907	3684.910	3684.927	3684.930	3684.743
85	431.5	431.5	203.2	-	-	3684.744	3684.745	3684.746	3684.747	3684.748

U-channel front panels as filler panels



Material

2,5 mm extruded aluminium section
Clear-chromated

Supply includes

1 front panel, one-piece
(with 2 – 14 HP version) or three-piece
(with > 14 HP version)
1 vertical EMC gasket, version 1
1 contact strip (three-piece only)
1 gasket strip (three-piece only)

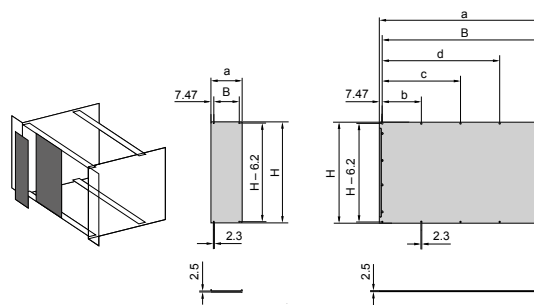

EMC

+ Also required

Slotted centering screws
packs of 100, order no. 3687.050
see page 203
Cross-head centering screws
packs of 100, order no. 3687.051
see page 203

HP	a mm	B mm	b mm	c mm	d mm	Order No.						
						1 U H = 39.8	2 U H = 84.25	3 U H = 128.7	4 U H = 173.15	6 U H = 262.05	7 U H = 306.5	9 U H = 395.4
2	9.8	-	-	-	-	-	-	3685.177	-	3685.185	-	3685.193
3	14.9	-	-	-	-	-	-	3686.138	-	3686.139	-	3686.140
4	20.0	-	-	-	-	-	-	3685.178	-	3685.186	-	3685.194
5	25.1	-	-	-	-	-	-	3685.179	-	3685.187	-	-
6	30.1	-	-	-	-	-	-	3685.180	-	3685.188	-	-
7	35.2	-	-	-	-	-	-	3685.181	-	3685.189	-	-
8	40.3	25.4	-	-	-	-	-	3685.182	-	3685.190	-	3685.195
10	50.5	35.6	-	-	-	-	-	3685.183	-	3685.191	-	-
12	60.6	45.7	-	-	-	-	-	3685.184	-	3685.192	-	3685.196
14	70.8	55.9	-	-	-	-	-	3684.249	-	3684.258	-	3684.278
16	80.9	66.0	-	-	-	-	-	3685.348	-	3685.349	-	-
20	101.3	86.4	-	-	-	-	-	3684.250	-	3684.259	-	3684.279
21	106.4	91.4	-	-	-	-	-	3684.272	-	3684.275	-	-
28	141.9	127.0	61.0	-	-	-	-	3684.251	-	3684.260	-	-
40	202.9	188.0	91.5	-	-	-	-	3684.273	-	3684.276	-	3684.280
42	213.0	198.1	96.5	-	-	-	-	3684.252	3684.255	3684.261	3684.264	3684.267
60	304.5	289.6	96.5	193.0	-	-	-	3684.274	-	3684.277	-	-
63	319.7	304.8	101.6	203.2	-	-	-	3684.253	3684.256	3684.262	3684.265	3684.268
84	426.4	411.5	101.6	203.2	304.8	3684.247	3684.248	3684.254	3684.257	3684.263	3684.266	3684.269

COMPONENTS AND ACCESSORIES

FRONT PANELS AND HANDLES

Front panels, hinged



Material
2.5 mm Aluminium
anodised

Supply includes
1 set of hinges
Assembly parts.

U	HP	Order No.	
		vertically hinged	horizontally hinged
3	42 ¹⁾	3652.600	3652.500
3	84 ¹⁾	3652.610	3652.510
3	85	-	3684.291
4	85	-	3684.292
6	42 ¹⁾	3652.620	3652.520
6	84 ¹⁾	3652.630	3652.530
6	85	-	3684.293
7	85	-	3684.294
9	85	-	3684.295

+ Also required

¹⁾ With rear mounting of 42 HP and 84 HP front panels, additional trim sections must be attached at the rear of the subrack.
Rear trim sections, see page 57

EMC front panels, hinged



Material
2.5 mm Aluminium
Clear-chromated

Supply includes
1 front panel
1 set of hinges
1 contact strip
1 gasket strip
1 vertical EMC gasket, version 1
Assembly parts

U	HP	Order No.
		horizontally hinged
3	84	3684.298
4	84	3684.299
6	84	3684.300
7	84	3684.301
9	84	3684.302



Door cut-out trim for subracks installed indoors



Material
Aluminium

Width	Packs of	Order No.
½ 19"	2	3634.060
19"	2	3634.070

Mezzanine front panels



Extruded aluminium section
For PCI mezzanine cards (PMC)
Conforms to IEEE 1386

Material/surface finish
Extruded aluminium section
clear-chromated

Packs of	Order No.
1	3688.658

+ Accessories

EMC seals
see page 181
Assembly screws M2.5 x 6,
packs of 100, order no. 3654.340,
see page 202

Mezzanine front panels



Die-cast zinc
For PCI mezzanine cards (PMC)
Conforms to IEEE 1386

Packs of	Order No.
1	3688.659

Material

Die-cast zinc

+ Accessories

EMC seals
see page 181
Assembly screws M2.5 x 6
packs of 100, order no. 3654.340
see page 202

Support spacers for mezzanine cards



10 mm, for mounting mezzanine cards

Packs of	Order No.
1	3688.663

Covers for mezzanine cut-outs

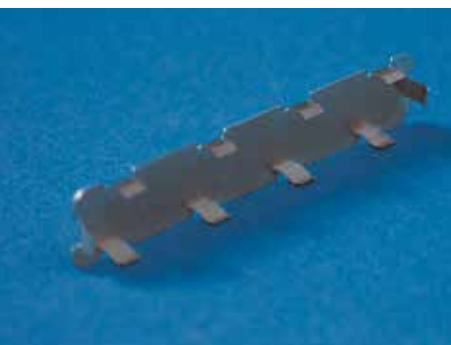

To conceal unused mezzanine cut-outs.
The covers are simply clipped into the
cut-outs.

Packs of	Order No.
1	3688.660

Material

Stainless steel

EMC seals for mezzanine front panels



For inserting into the all-round channel of
the mezzanine front panels.

Material/surface finish

Sealing ring made of conductive carbon
filled silicon, sealing gasket made from
stainless steel

Design	Packs of	Order No.
Sealing ring	1	3688.661
Sealing gasket	1	3688.662

COMPONENTS AND ACCESSORIES

BOX-TYPE PLUG-IN UNITS

HeiPac box-type plug-in units – type I



Technical specifications

Installation depth: 160 and 220 mm
 Height: 3 U and 6 U to IEC 60 297-3
 Rear panel to accommodate single connectors

Material

Front panel: 2.5 mm aluminium, pure anodised
 Rear panel: 2 mm aluminium, untreated
 Side panel profile: extruded aluminium profile, pure anodised
 Handle: aluminium, pure anodised
 PCB holder: plastic

Available on request

- box-type plug-in units in special sizes or printed
- EMC box-type plug-in units with EMC front panels

+ Accessories

Covers
 see page 184
 Guide rails
 see page 158
 Individual components
 see page 184

HP	a mm	B mm	b mm	c mm	C mm	d mm	e mm	f mm	Order No.			
									3 U	3 U	6 U	
Board depth 160 mm												
6	32.2	-	20.3	27.5	-	171.5	122	167	3653.000	-	-	
8	40.3	-	30.5	36.0	-	171.5	122	167	-	3653.010	-	
10	50.5	35.6	40.6	46.2	-	171.5	122	167	-	3653.020	3653.100	
12	60.6	45.7	50.8	56.4	-	171.5	122	167	-	3653.030	3653.110	
14	70.8	55.9	60.9	66.5	-	171.5	122	167	-	3653.040	3653.120	
21	106.3	91.4	96.4	102.0	86.3	171.5	122	167	-	3653.050	3653.130	
28	141.9	127.0	132.0	137.6	121.8	171.5	122	167	-	3653.060	3653.140	
42	213.1	198.1	203.2	208.8	193.0	171.5	122	167	-	3653.070	3653.150	
Board depth 220 mm												
10	50.5	35.6	40.6	46.2	-	231.5	182	227	-	3653.200	3653.300	
12	60.6	45.7	50.8	56.4	-	231.5	182	227	-	3653.210	3653.310	
14	70.8	55.9	60.9	66.5	-	231.5	182	227	-	3653.220	3653.320	
21	106.3	91.4	96.4	102.0	86.3	231.5	182	227	-	3653.230	3653.330	
28	141.9	127.0	132.0	137.6	121.8	231.5	182	227	-	3653.240	3653.340	
42	213.1	198.1	203.2	208.8	193.0	231.5	182	227	-	3653.250	3653.350	
Supply includes												
Front panel									1	1	1	
Handle									1	1	2	
Side panel									1	2	2	
Cover plate incl. rear panel									1	-	-	
Rear panel									-	1	2	
PCB holder									2	2	2	
Assembly parts (set)									1	1	1	

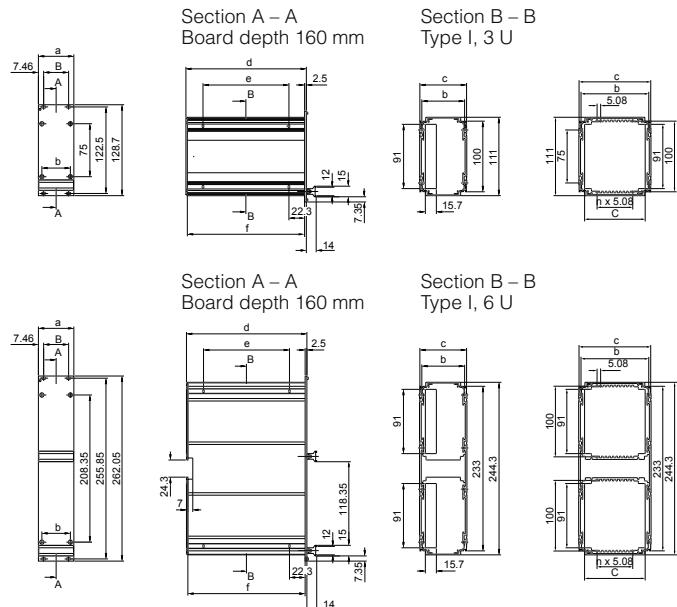

PCB holder for box-type plug-in units



For fastening PCBs in box-type plug-in units.

Material

PBTP,
Basic material to UL 94-V0

Supply includes

Assembly parts

Packs of	Order No.
2	3606.321

Guide rails for drive chassis



For routing drive chassis in the subrack.

Material

Aluminium

Supply includes

Press-fit pin

Note

Two guide rails are required for each drive chassis.
Guide rails 4.4" for plastic drives, see page 158

For installation depth mm	Packs of	Order No.
160	1	3686.989

+ Also required

Assembly screws
packs of 100, order no. 3654.340
see page 202

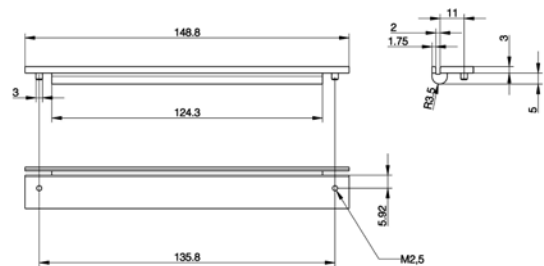

COMPONENTS AND ACCESSORIES

BOX-TYPE PLUG-IN UNITS

HeiPac box-type plug-in units – individual components

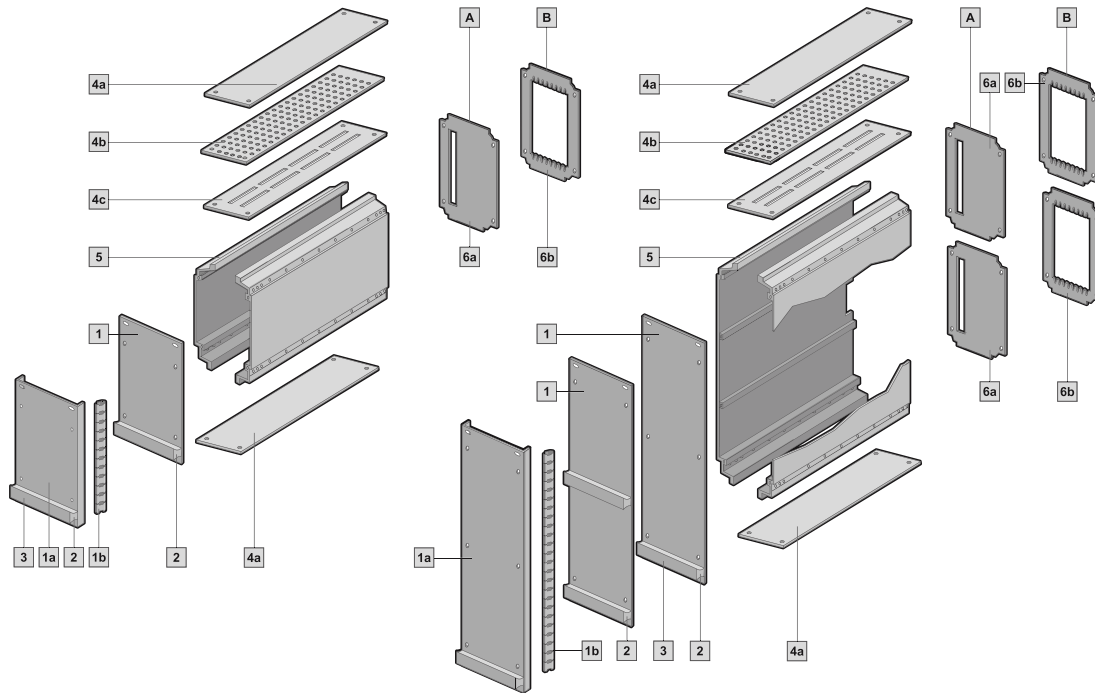

HeiPac box-type plug-in units, types I and II in 3 U and 6 U, individual components

Type I for one connector/type II for several connectors

Box-type plug-in units, individual components	A Type I	B Type II	Packs of	8 HP	10 HP	12 HP	14 HP	21 HP	28 HP	42 HP	Page
Front panels of 2.5 mm aluminium, anodised surface finish											
1 for 3 U	•	•	1	3685.769	3685.629	3685.630	3685.631	3685.636	3685.637	3685.638	-
for 6 U (for 1 handle)	•	•	1	3685.767	3685.633	3685.634	3685.635	3685.639	3685.640	3685.641	-
for 6 U (for 2 handles)	•	•	1	-	3687.520	3687.521	3687.522	3687.523	3687.524	3687.525	-
EMC front panels of 2.5 mm aluminium, surface finish clear-chromated (only for use in conjunction with 10 HP box-type plug-in unit)											
1a for 3 U/10 HP box-type plug-in units	•	•	1	-	-	3687.587	-	-	-	-	-
for 6 U/10 HP box-type plug-in units	•	•	1	-	-	3687.588	-	-	-	-	-
EMC gaskets , vertical, for front panels											
1b for 3 U	•	•	1	-	-	3686.975	-	-	-	-	146
for 6 U	•	•	1	-	-	3686.977	-	-	-	-	146
Handle type V											
2 of aluminium, anodised surface finish	•	•	1	3685.600	3685.601	3685.602	3685.603	3685.761	3685.762	3685.763	176
of plastic	•	•	1	3685.492	-	3685.493	-	3685.494	-	-	176
Identification strips											
3 of 0.5 mm aluminium, anodised surface finish	•	•	1	3685.751	3685.752	3685.753	3685.754	3685.755	3685.756	3685.757	177
Covers 4a 4b of 1 mm aluminium, untreated 4c of 1.2 mm sheet steel, painted, RAL 9006 (with vent slots)											
4a unvented, for board depth 160 mm	•	•	1	3687.555	3685.689	3685.690	3685.691	3685.692	3685.693	3685.694	-
unvented, for board depth 220 mm	•	•	1	3687.562	3685.701	3685.702	3685.703	3685.704	3685.705	3685.706	-
4b vented, for board depth 160 mm slide-in	•	•	1	3687.585	3685.683	3685.684	3685.685	3685.686	3685.687	3685.688	-
vented, for board depth 220 mm slide-in	•	•	1	-	3685.695	3685.696	3685.697	3685.698	3685.699	3685.700	-
4c vent slots for guide rails, for board depth 160 mm	•	•	1	-	3687.556	3687.557	3687.558	3687.559	3687.560	3687.561	-
vent slots for guide rails, for board depth 220 mm	•	•	1	-	3687.563	3687.564	3687.565	3687.566	3687.567	3687.568	-
Side panel of extruded aluminium section, anodised surface finish											
5 3 U, for board depth 160 mm	•	•	1	-	-	-	3685.645	-	-	-	-
6 U, for board depth 160 mm	•	•	1	-	-	-	3685.648	-	-	-	-
3 U, for board depth 220 mm	•	•	1	-	-	-	3685.646	-	-	-	-
6 U, for board depth 220 mm	•	•	1	-	-	-	3685.649	-	-	-	-
Rear panel 6a of 2.0 mm aluminium, untreated 6b of 1.2 mm sheet steel, spray-finished											
6a for 1 connector	•	-	1	3687.536	3685.707	3685.708	3685.709	3685.710	3685.711	3685.712	-
6b for several connectors	-	•	1	-	-	-	-	3687.537	3687.538	3687.539	-

Assembly parts for box-type plug-in units, see page 202

HeiPac box-type plug-in units – individual components

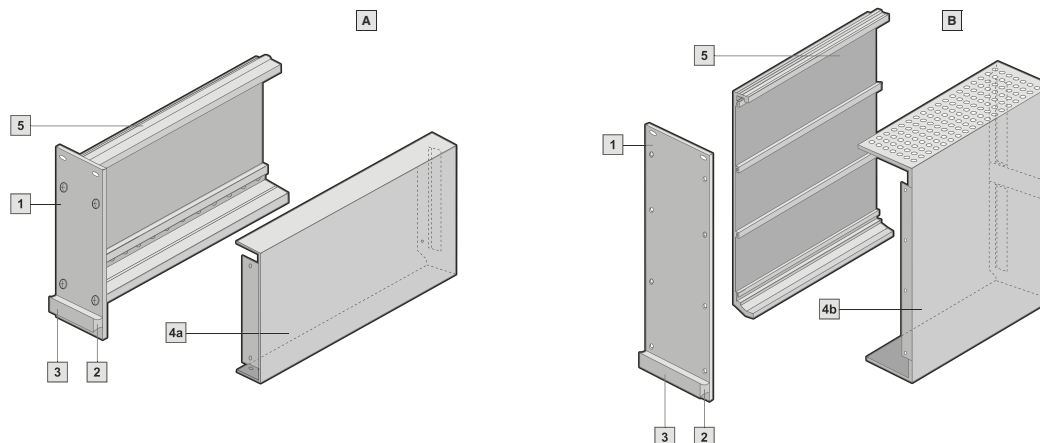

HeiPac box-type plug-in units, types V and VI in 3 U and 6 U, in individual components

Type V with cover (unvented)/type VI with cover (vented)

Box-type plug-in units, individual components	A Type I	B Type II	Packs of	6 HP	7 HP	8 HP	10 HP	12 HP	14 HP	Page
---	-------------	--------------	----------	------	------	------	-------	-------	-------	------

Front panels of 2.5 mm aluminium, anodised surface finish

1 for 3 U	•	•	1	3685.768	3685.628	3685.769	3685.629	3685.630	3685.631	-
for 6 U	•	•	1	3685.766	3685.632	3685.767	3685.633	3685.634	3685.635	-

Handle type V

2 of aluminium, anodised surface finish	•	•	1	3685.598	3685.599	3685.600	3685.601	3685.602	3685.603	176
of plastic	•	•	1	-	-	3685.492	-	3685.493	-	176

Identification strips for 3 U

3 of 0.5 mm aluminium, anodised surface finish	•	•	1	3685.749	3685.750	3685.751	3685.752	3685.753	3685.754	177
--	---	---	---	----------	----------	----------	----------	----------	----------	-----

Cover 4a 4b of 1 mm aluminium, clear-chromated surface finish

4a unvented, 3 U, for board depth 160 mm	•	-	1	3685.774	3685.658	3685.776	3685.659	3685.660	3685.661	-
unvented, 3 U, for board depth 220 mm	•	-	1	3685.775	3685.674	3685.777	3685.675	3685.676	3685.677	-
unvented, 6 U, for board depth 160 mm	•	-	1	3685.717	3685.662	3685.764	3685.663	3685.664	3685.665	-
unvented, 6 U, for board depth 220 mm	•	-	1	3685.718	3685.678	3685.765	3685.679	3685.680	3685.681	-
4b vented, 3 U, for board depth 160 mm	-	•	1	3685.770	3685.650	3685.772	3685.651	3685.652	3685.653	-
vented, 3 U, for board depth 220 mm	-	•	1	3685.771	3685.666	3685.773	3685.667	3685.668	3685.669	-
vented, 6 U, for board depth 160 mm	-	•	1	3685.713	3685.654	3685.715	3685.655	3685.656	3685.657	-
vented, 6 U, for board depth 220 mm	-	•	1	3685.714	3685.670	3685.716	3685.671	3685.672	3685.673	-

Side panel of extruded aluminium section, anodised surface finish

5 3 U, for board depth 160 mm	•	•	1				3685.645			-
6 U, for board depth 160 mm	•	•	1				3685.648			-
3 U, for board depth 220 mm	•	•	1				3685.646			-
6 U, for board depth 220 mm	•	•	1				3685.649			-

Assembly parts for box-type plug-in unit types I, II, V, VI

Description	for installation of:	Packs of	Order. No.	
Assembly kit for box-type plug-in unit I/II, 3 U	Box-type plug-in units, type I/II, 3 U	1 set	3687.589	-
Assembly kit for box-type plug-in unit I/II, 6 U	Box-type plug-in units, type I/II, 6 U	1 set	3687.590	-
Assembly kit for box-type plug-in unit type V/VI	Box-type plug-in units, type V/VI	1 set	3685.294	-
Assembly kit for box-type plug-in unit with EMC front panel	Box-type plug-in unit with EMC front panel	1 set	3687.591	-
Assembly kit for plastic handles	Plastic handles on box-type plug-in units	1 set	3687.519	202

Guide rails for box-type plug-in units, see page 158

For more screws, see page 202

COMPONENTS AND ACCESSORIES

CLIMATE CONTROL

Vertical cooling from bottom to top

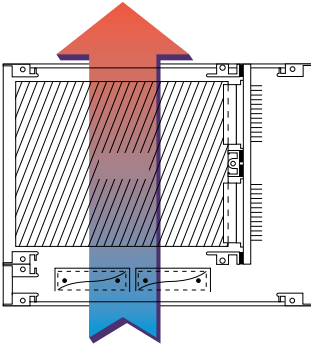

- Air flow via normal convection or forced cooling devices in the enclosure or housing outside of the subrack
- Vertical forced air flow, supported by fans installed at the bottom of the subrack (1 U)

Fan mounting plate

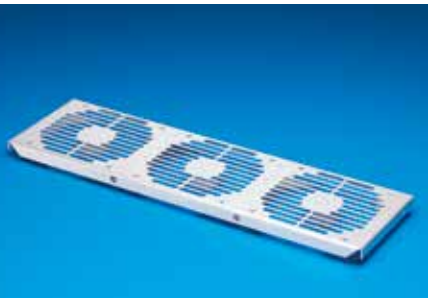

For the installation of 120 mm fans and filter modules in 4 U and 7 U subracks.
For mounting on the subrack side panels.

Material

1.5 mm aluminium, anodised

U	For PCB depth mm	No. of fan mounting plates required	HP	Order No.
1	160	1	84	3684.317
	220	1		
	280	2		
	340	2		
	400	3		

+ Also required

1 terminal block is required for each subrack.

Packs of	Order No.
1	3686.805

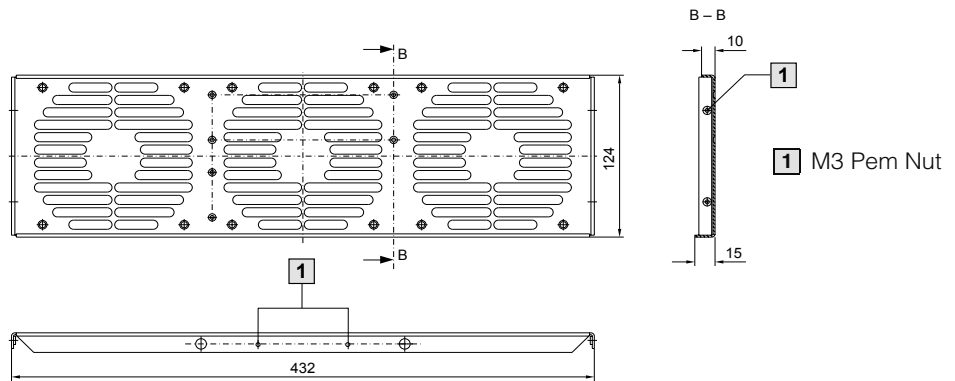
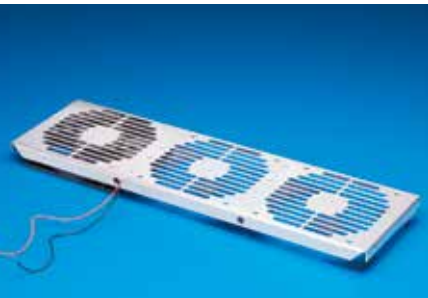

Diagonal cooling from front to back

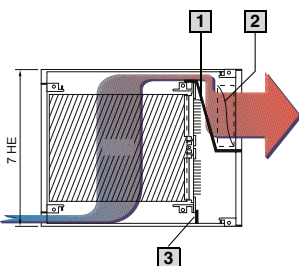

Diagonal air flow from front to back allows individual cooling of PCBs in vertical installation position. An air baffle and air partition ensure controlled air flow.

- 1 Air baffle, see page 187
- 2 Fan (mounted on the rear panel), see page 190
- 3 Air partition, see page 187

Air baffle



For controlled air flow in 7 U subracks. For mounting on sub-rack side panels with the aid of mounting blocks.

Material
1 mm Aluminium

Supply includes
Assembly parts

Subrack depth mm	Order No.
285	3685.302
345	3685.303
405	3684.320
465	3684.321
525	3684.322

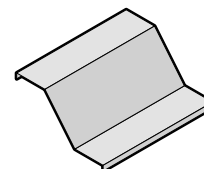
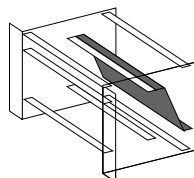

Air partition



For controlled air flow in the sub-rack. The partitions are mounted on the horizontal rails together with the backplanes.

Material
Epoxy

Height U	Order No.
1/2	3684.870
1	3684.871
3	3684.872

+ Also required

Fastening screws and washers
packs of 100, order no. 3684.019
see page 202

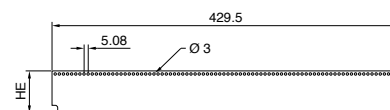
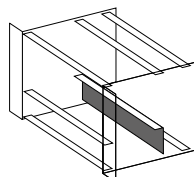

Front/rear panels for ventilation



Non-EMC version

Material
2.5 mm Aluminium

Surface finish
Anodised

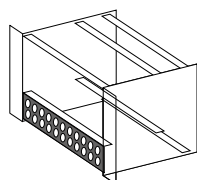

Non-EMC version

U	HP	Packs of	Order No.
1	84	1	3684.812
2	84	1	3684.813
3	84	1	3684.814

+ Also required

Screws and collars, packs of 100 sets,
Order no. 3658.160
see page 202

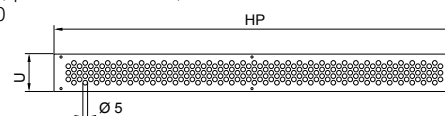

EMC version

Material
2.5 mm Aluminium

Surface finish
Clear-chromated

Supply includes
1 front panel
1 contact strip
1 gasket strip
1 vertical EMC gasket
Assembly parts

EMC version

U	HP	Packs of	Order No.
1	84	1	3684.281
2	84	1	3684.282
3	84	1	3684.283

+ Also required

Centering screws
see page 203

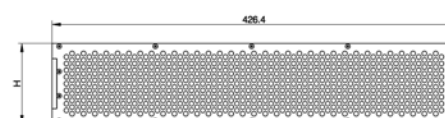

COMPONENTS AND ACCESSORIES

CLIMATE CONTROL

Rear panels for fan installation

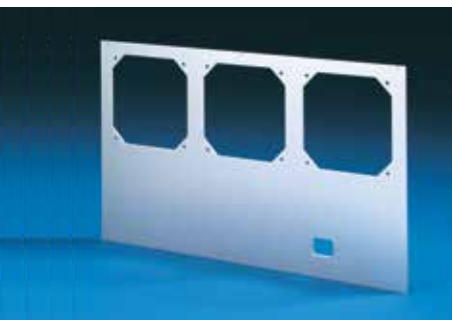

Non-EMC version

Material
2.5 mm Aluminium

Surface finish
Anodised

Non-EMC version

U	HP	For fans mm	Packs of	Order No.
3	85	80	1	3684.839
4	85	80	1	3684.840
6	85	120	1	3684.841
7	85	120	1	3684.842

+ Also required

Screws and collars
packs of 100 sets, order no. 3658.160
see page 202

EMC version

Material
2.5 mm Aluminium

Surface finish
Clear-chromated

Supply includes
1 rear panel
1 contact strip
1 gasket strip
1 vertical EMC gasket
assembly parts

EMC version

U	HP	For fans mm	Packs of	Order No.
3	84	80	1	3684.284
4	84	80	1	3684.285
6	84	120	1	3684.286
7	84	120	1	3684.287

+ Also required

Centering screws
see page 203

+ Accessories

Fans
see page 190

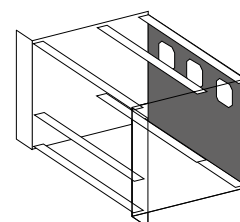
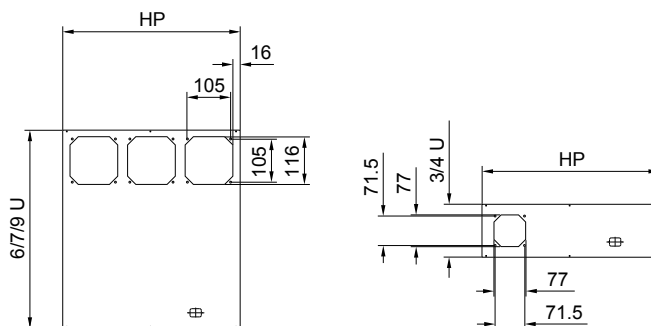

Rear panels, horizontally hinged for fan installation



Non-EMC version

Material
2.5 mm Aluminium

Surface finish
Anodised

Supply includes
1 rear panel
1 set of hinges
assembly parts

Non-EMC version

U	HP	For fans mm	Packs of	Order No.
3	85	80	1	3684.304
4	85	80	1	3684.305
6	85	120	1	3684.306
7	85	120	1	3684.307

+ Also required

Screws and collars
packs of 100 sets, order no. 3658.160
see page 202

EMC version

Material
2.5 mm Aluminium

Surface finish
Clear-chromated

Supply includes
1 rear panel
1 contact strip
1 gasket strip
1 vertical EMC gasket
1 set of hinges
assembly parts

EMC version

U	HP	For fans mm	Packs of	Order No.
3	84	80	1	3684.311
4	84	80	1	3684.312
6	84	120	1	3684.313
7	84	120	1	3684.314

+ Also required

Centering screws
see page 203

+ Accessories

Fans
see page 190

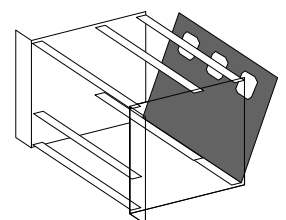
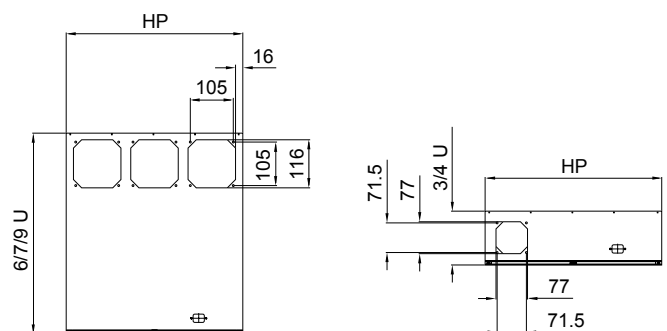

COMPONENTS AND ACCESSORIES

CLIMATE CONTROL

AC fans



For subracks and microcomputer systems

Supply includes

1 fan without connection cable

+ Also required

Assembly screws
packs of 1 set, order no. 3685.197
see page 203

AC fans

Dimensions			Bearing	Rated voltage V/Hz	Power Watts	Noise level dB(A)	Temperature range °C	Volume flow m ³ /h	Order No.
Fan mm	A mm	B mm							
80	79.5	71.5	Ball bearing	115/60	11.0	42	-40 bis +95	57	3686.645
80	79.5	71.5	Ball bearing	230/50	12.0	37	-40 bis +90	48	3686.646
120	119.0	104.8	Ball bearing	115/60	18.0	51	-40 bis +90	180	3686.643
120	119.0	104.8	Ball bearing	230/50	19.0	47	-40 bis +85	160	3686.644

Connection cable

Cable length mm	Packs of	Order No.
610	1	3686.658
1000	1	3686.659

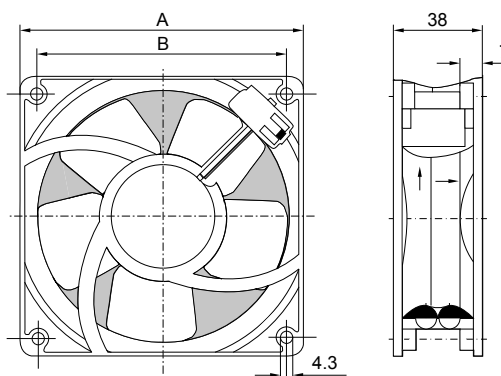

DC fans



Optionally available with temperature-dependent speed control via additional temperature sensor.

Supply includes

1 fan with connection cable (310 mm)

+ Also required

Assembly screws
 packs of 1 set, order no. 3685.197
 see page 203
 Temperature sensor for DC fans with speed control
 see page 192

DC fan with speed control and alarm signal

Dimensions			Bearing	Rated voltage V (DC)	Voltage range Volt	Power Watt	Noise level dB(A)	Temperature range °C	Volume flow m ³ /h	Order No.
Fan mm	A mm	B mm								
80	79.5	71.5	Ball bearing	12	8,0 - 14,0	2,2	34	-20 bis +65	48	3686.649
80	79.5	71.5	Ball bearing	24	21,6 - 26,4	2,4	36	-20 bis +65	54	3686.650
120	119.0	104.8	Ball bearing	12	8,0 - 13,2	5,5	45	-20 bis +65	170	3686.647
120	119.0	104.8	Ball bearing	24	21,0 - 27,0	5,4	45	-20 bis +65	170	3686.648

DC fan without speed control and without alarm signal

Dimensions			Bearing	Rated voltage V (DC)	Voltage range Volt	Power Watt	Noise level dB(A)	Temperature range °C	Volume flow m ³ /h	Order No.
Fan mm	A mm	B mm								
80	80.0	71.5	Ball bearing	12	6,0 - 15,0	1,8	34	-20 bis +75	48	3687.612
80	80.0	71.5	Ball bearing	24	12,0 - 28,0	2,1	34	-20 bis +75	48	3687.613
120	119.0	104.8	Ball bearing	12	6,0 - 15,0	2,6	39	-20 bis +75	140	3687.614
120	119.0	104.8	Ball bearing	24	12,0 - 28,0	2,6	39	-20 bis +75	140	3687.615

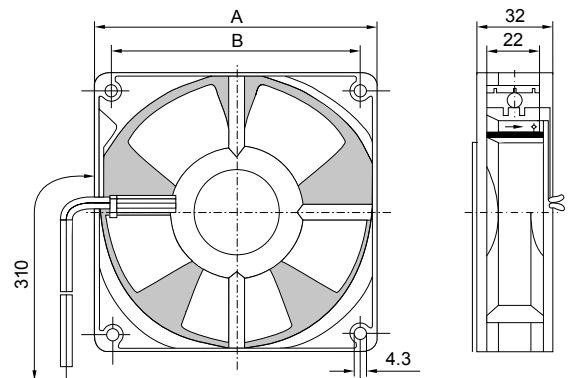

COMPONENTS AND ACCESSORIES

CLIMATE CONTROL

Temperature sensor



For DC fans 12/24 V with speed control

Voltage	Packs of	Order No.
12 V/24 V (DC)	1	3686.657

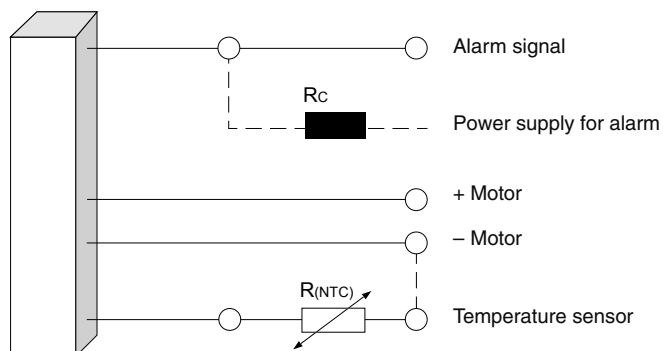
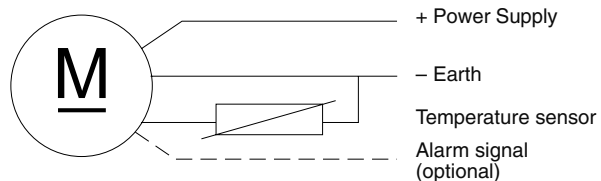

Finger guard



For AC fans and DC fans

Material

Polyamide
Self-extinguishing to UL 94-V0

Colour

Black

For fans mm	Packs of	Order No.
80	1	3686.656
120	1	3686.655

EMC shielding plate

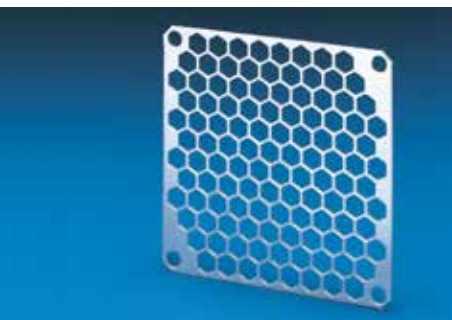

For AC fans and DC fans

Material

1 mm aluminium
Clear-chromated

For fans mm	Packs of	Order No.
80	1	3686.359
120	1	3686.329

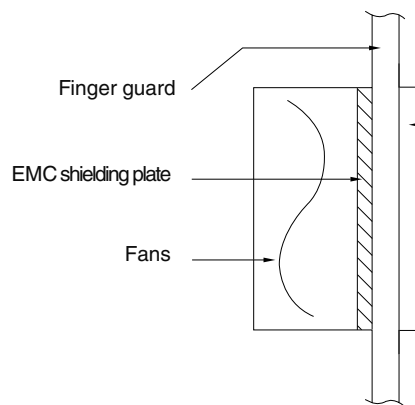

Air block panel for unused slots



To conceal unused slots and prevent unwanted airflow. The air block panel simply snaps into position on the guide rails.

Material

Polycarbonate
Self-extinguishing to UL 94-V0

Colour

Blue

Note

Not suitable for use in conjunction with guide rails with 1/2 HP offset.

For keyable guide rail mm	Packs of	Order No.
160	1	3687.924



COMPONENTS AND ACCESSORIES

POWER SUPPLIES

Maximum performance with efficient power supply

HEITEC offers an extensive range of power supply units in various designs:

The range includes 482.6 mm (19") compatible, Open Frame and PS/2 variants to supply DC voltage to controllers, systems and plant in many different areas.



- Open Frame (VME)
- 3 U, 6 U (VME), plug-in
- 3 U, 6 U (CPCI), plug-in
- PS/2 (AT/ATX)
- UPS

Open Frame (VME)



E.g. 400 Watt

Order no. see page 196

Applications

Power supplies for VMEbus systems

Technical specifications

- 400 Watt
- Open frame version
- For installing on mounting base or rear panel
- Built-in fans
- Wide-range input
- Aluminium case
- 3 outputs

Benefits at a glance

- Small size with high power output
- All-purpose model
- Approvals: EN 60 950, UL 1950, IEC 950 and CSA 22.2 No. 234
- Compact design

3 U, 6 U, plug-in (VME)

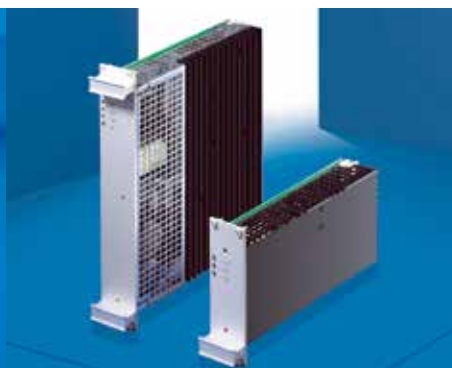

E.g. 130, 160, 270 Watt

Order no. see page 197

Applications

Plug-in power supply for VMEbus systems with integrated VMEbus signalling

Technical specifications

- 130, 160, 270 Watt
- 482.6 mm (19") rack-mount unit to IEC 60 297-3
- Installation depth 160 mm
- Mounted by guide rails
- Connection via connectors H15, IEC 60 603-2
- 3 outputs

Benefits at a glance

- 482.6 mm (19") compatible
- Easily exchangeable
- Approvals: EN 60 950, VDE 0805 and IEC 950

3 U, 6 U, plug-in (CPCI)

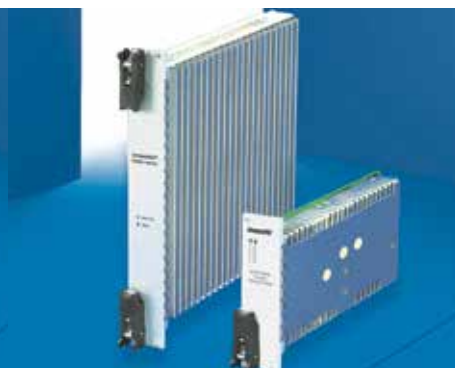

Z.B. 250, 350 Watt

Order no. see page 198

Applications

Plug-in power supply for CompactPCI systems

Technical specifications

- 250, 350 Watt
- 482.6 mm (19") rack-mount unit to IEC 60 297-3
- Installation depth 160 mm
- Mounted by guide rails
- Connection via connectors type Positronic, 47-pole PICMG 2.9
- 4 outputs

Benefits at a glance

- 482.6 mm (19") compatible
- Easily exchangeable
- Approvals: EN 60 950 A1-A4, CSA 22.2, UL 1950, CE
- Conforms to PICMG specification

PS/2 (AT/ATX)



E.g. 250, 300, 400 Watt

Order no. see page 199

Applications

Power supply unit for ATX- and CPCI systems

Technical specifications

- 250, 300, 400 Watt
- Open frame version
- For installing on mounting base or rear panel
- Built-in fan
- Sheet steel case
- PFC active/passive

Benefits at a glance

- All-purpose model
- Approvals: CSA

Redundant



E.g. 2 x 300 Watt

Redundant power supply units on request

COMPONENTS AND ACCESSORIES

POWER SUPPLIES

HeiPac power supplies – Open Frame

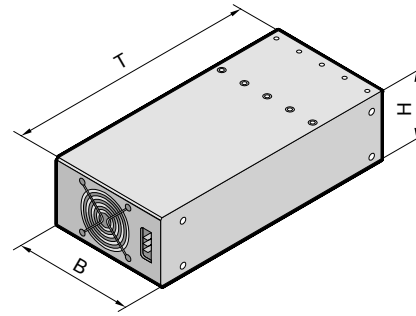

	400 W		
Height (H) mm	63.0		
Width (B) mm	126.5		
Depth (T) mm	279.0		
Order No.	3686.629		
Output sizes			
Output	1	2	3
Output voltage	5 V	+ 12 V	- 12 V
Output current	85 A	8 A	
Maximum power output	400 W		
Setting range of output voltage	2.5 V - 5.7 V (85 A)	5 - 16 V	
Load compensation (load variation 0 - 100 %)	< 0.5 %		
Line regulation ($U_{e \text{ min.}} - U_{e \text{ max.}}$)	< 25 mV	< 60 mV	
Base load	-		
Infeed compensation (Sense)	0,5 V	-	
Residual ripple (max.)	1 %	2 %	
Temperature coefficient	0.03 % / °C		
Overvoltage protection	yes		
Overload protection ¹⁾	Thermal current limiting		
Overload protection, thermal	-		
Overload protection, electronic	-		
Input variables			
Mains voltage U_e	90 - 264 V AC		
Mains frequency	47 - 63 Hz		
Power factor	> 0.95		
Startup current limitation	< 50 A		
Efficiency (typ.)	75 %		

HeiPac power supplies for VME, plug-in

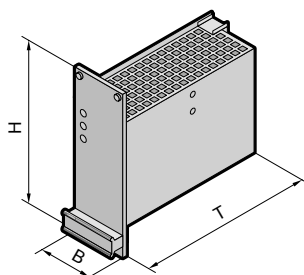
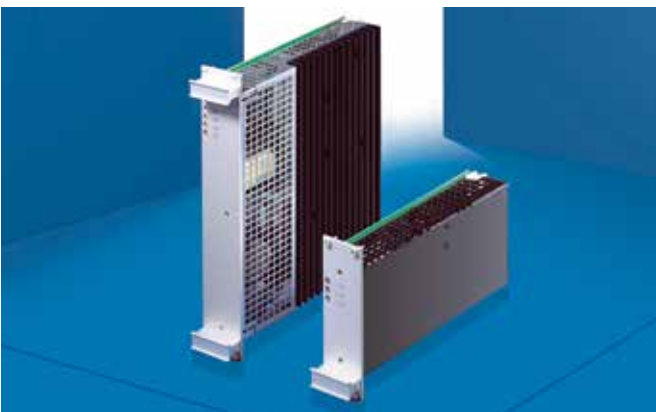

1

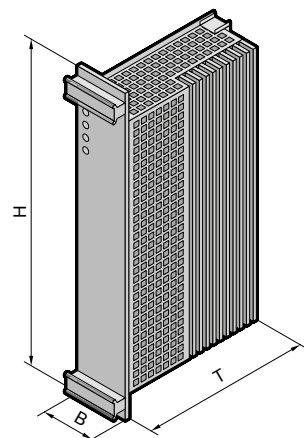

2

	1			2		
Height (H)	3 U			6 U		
Width (B)	10 HP			8 HP	12 HP	
Depth (T) mm	170.0			170.0	170.0	
Order No. power supply	3686.469			3686.471	3685.306	
Order No. front panel	3685.304			3686.472	3685.307	
Output sizes						
Output	1	2	3	1	2	3
Output voltage	5 V	+ 12 V	- 12 V	5 V	+ 12 V	- 12 V
Output current 3 U, 10 HP/6 U, 8 HP	14 A	5 A	2 A	20 A	5 A	2 A
Output current 3 U, 12 HP/6 U, 12 HP	-	-	-	35 A	6 A	2 A
Maximum power output	130 W			160 W (8 HP), 270 W (12 HP)		
Setting range of output voltage	± 5 %	-	-	± 5 %	-	-
Load compensation (load variation 0 - 100 %)	< 0.1 %	< 1 %	-	< 0.1 %	< 1 %	-
Line regulation ($U_{e \text{ min.}} - U_{e \text{ max.}}$)	< 0.2 %			< 0.2 %		
Base load	-			-		
Compensation time	< 1 ms at I_a 20 - 80 %			< 1 ms at I_a 20 - 80 %		
Infeed compensation (Sense)	± 0.25 V	-	-	± 0.25 V	-	-
Residual ripple (max.)	< 35 mV		< 20 mV	< 45 mVss	< 30 mVss	< 15 mVss
Interference voltage	50 mVss typ. (bandwidth 20 MHz)			< 80 mVss typ. (sum of all interference parts)		
Temperature coefficient	0.025 % / K			0.025 % / K		
Overvoltage protection (automatically recovery)	125 % ± 5 %	125 % ± 10 %		125 % ± 5 %	120 % ± 10 %	
Overload protection	typ. 110 % $I_{a \text{ rated}}$, U/I characteristic curve acting on all outputs, outputs short circuit-resistant					
Overtemperature protection	Cuts out if the internal temperature is too high, cuts in again with hysteresis					
AC-Fail, SYSRESET	TTL signals with 48 mA drive current, active low					
ON delay	< 0.5 s			< 0.5 s		
Ramp-up time	≤ 50 ms			≤ 50 ms		
Input variables						
Mains voltage U_e	AC 187 - 264 V, 50/60 Hz with automatic changeover to AC 99 - 138 V			AC 187 - 264 V, 50/60 Hz with automatic changeover to AC 99 - 138 V		
Mains frequency	50 - 60 Hz			50 - 60 Hz		
Efficiency (typ.)	80 %			80 %		
Startup current limitation	< 10 As typ. - in cold state < 15 As typ. - in warm state			< 25 As typ. - in cold state < 35 As typ. - in warm state		
Fuse	4 AT			8 AT		

COMPONENTS AND ACCESSORIES

POWER SUPPLIES

HeiPac power supplies for CPCI, plug-in

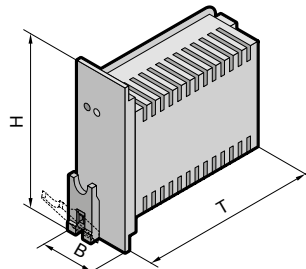
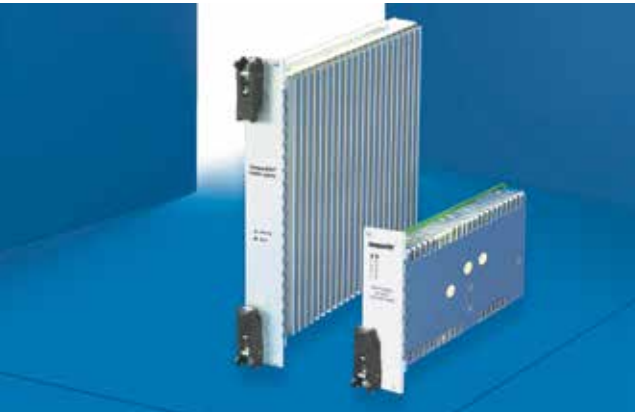

1

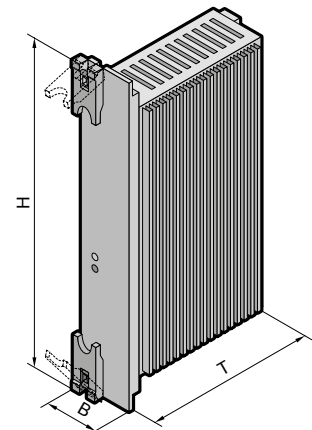

2

	1	2
Height (H)	3 U	6 U
Width (B)	8 HP	8 HP
Depth (T) mm	170.0	170.0
Order No.		
AC power supply	3688.695	3688.528
Stromversorgung DC		
DC power supply		
Output sizes		
Output		U ₁ U ₂ U ₃ U ₄ U ₁ U ₂ U ₃ U ₄
Output voltage		5 V 3,3 V 12 V -12 V 5 V 3,3 V 12 V -12 V
Output current		33 A 33 A 6 A 1 A 40 A 40 A 9 A 1 A
Output current U ₁ and U ₂		55 A max. 80 A max.
Maximum power output		250 W 350 W
Base load (only U ₁)		5 % - 5 %
Load compensation (dyn.)	< 3 % at 25 % load variation (1 A/μs) 1 % after 300 μs	
Line regulation	< ± 1 % (90s - 264 V AC)	
Infeed compensation (Sense)		0.25 V 0.25 V 0.25 V - 0.25 V 0.25 V 0.25 V -
Residual ripple (PARD)	50 mVss oder 1 % (bandwidth 20 MHz)	
Temperature coefficient	< ± 0.02 % / K (0° - 50 °C) after 20 min. start-up time	
Overvoltage protection	125 % ± 10 %, reset by switching on again	
Overload protection	Current limiting of all outputs, automatic return at normal load	
Overtemperature protection	At overtemperature switches off all outputs, automatic return at normal temperature	
Input variables		
Mains voltage or DC input	90 - 264 V AC, 47 - 63 Hz, 3.6 A max.	90 - 264 V AC, 47 - 63 Hz, 7 A
Power Factor	0.99 bei AC 115 V, full load	
Starting current	15 As (115 V AC) cold start, 30 As (230 V AC) cold start	
Fuse	4 A, 250 V AC	10 A, 250 V AC
Signals and control cables		
Power Fail (Pin 42)	In the event of a mains failure > 4 ms before output voltages exit control range. Power fail also triggered by failure or under-voltage of V1 or V2 (3 U) or any output (6 U)	
DEG (Pin 38)	In case of overtemperature	-
Remote Enable	Use logic „0“ (TTL level)	
Remote inhibit	Use logic „1“ (TTL level)	
LED displays, two-colour	Green: "Power ON" and output voltages present Red: Error	

AT/ATX power supply



For ATX

- PS/2 model
- Built-in fan
- Short circuit-protected
- CSA-approved
- On/off switch
- PFC active/passive
- W x H x D = 86 x 150 x 140 mm
- 47 – 63 Hz

Supply includes

Connection cable

Design	Power	Packs of	Order No.
AT	300 W	1	3688.118
ATX	400 W	1	9916.222

Technical specifications

3688.118	9916.222
300 W max. / 230 V AC	400 W max. / 90 - 240 V AC
5.0 V / 30.0 A	3.3 V / 20.0 A
- 5.0 V / 0.5 A	5.0 V / 20.0 A
12.0 V / 12.0 A	- 5.0 V / 0.3 A
- 12.0 V / 0.5 A	12.0 V / 32 A
PFC passive	- 12.0 V / 32 A
	+ 5 VSB / 2.5 A
	3.3 V u. 5 V plus max. 150 W
	3.3 V, 5 V & 12 V plus max. 385 W
	PFC active

ATX power supply 1 U



For ATX

- 2 built-in fans
- Short circuit-protected
- On/off switch
- PFC active
- W x H x D = 85 x 40 x 230 mm

Supply includes

Connection cable

Design	Packs of	Order No.
ATX	1	3688.130

Technical specifications

3688.130
250 W max. / 90 - 264 V AC
47 - 63 Hz
3.3 V / 16.0 A
5.0 V / 18.0 A
- 5.0 V / 0.3 A
12 V / 18 A
- 12 V / 0,8 A
+ 5 VSB / 2.5 A
+ 3.3 V u. 5 V plus max. 120 W

COMPONENTS AND ACCESSORIES

POWER SUPPLIES

Front panel



For ATX power supply
Front panel with cut-outs for mounting the
ATX power supply units in the subrack.

Material

Aluminium
Clear-chromated

Supply includes

Assembly parts
EMC gaskets (with EMC version)

U	HP	Order No.	
		EMC	Non-EMC
3	42	3685.331	3685.328
6	21	3685.332	3685.329

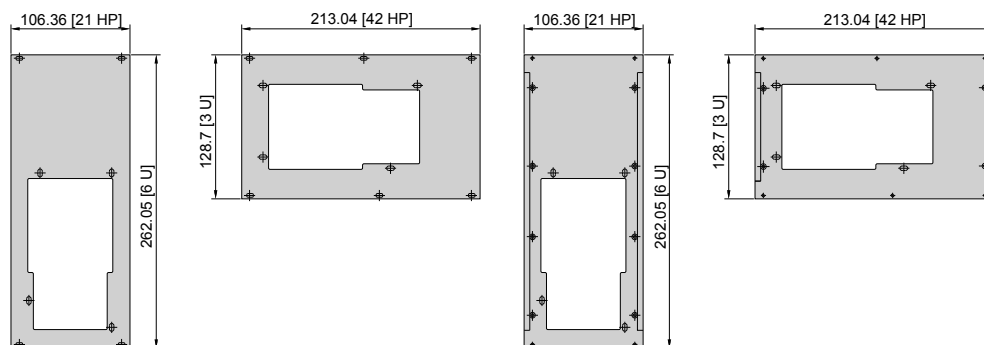

Mounting base for power supplies



- For ATX
- Attaches to the subrack side panel

Material

2 mm Aluminium
Clear-chromated

Supply includes

Assembly parts

Width (B) mm	Depth (T) mm	Order No.
431.8	100	3684.323
431.8	130	3684.324

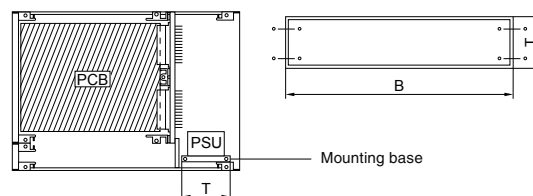

Female connector type M24/8



IEC 60 603-2

- Female connector for plug-in CPCI power supplies
- Quality level 2 to IEC 60 603-2 (DIN 41 612)
- Optional 20 A high current contacts for straight conductor connection either crimp or solder
- Volume resistance max. 1.5 mΩ
- Max. rated current: 40 A

Supply includes

5 connection sockets (crimping or soldering method)

Type of connection	Packs of	Order No.
Soldering	1 set	3687.665
Crimping	1 set	3687.666











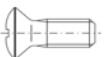
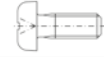

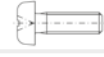

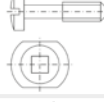

+ Also required

For mounting in the subrack, a Z rail is required see page 144



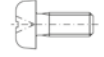

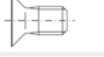



















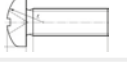

COMPONENTS AND ACCESSORIES

ASSEMBLY PARTS

Assembly parts

For the attachment of	Description	Dimensions	Order No.	Packs of
Front panels to unit side panels	Oval csk-screw ISO 7047-4.8-Z-A2K	M3 x 8 	3606.550	100
Rear panels to box-type plug-in units	Panhead screw ISO 7045-4.8-Z-A2K	M3 x 8 	3606.560	100
PCB holders (plastic) to front panels, top	Oval csk-screw ISO 7047-4.8-Z-A2K	M2.5 x 10 	3606.610	100
- Horizontal rails to side panels - Divider panels to horizontal rails - Horizontal rails to vertical supports	Panhead self-locking screw similar to DIN ISO 7045-8.8-Z-A2K	M4 x 12 	3654.300	100
Front/rear horizontal rails for side panels (HeiPac EASY)	Drill screw, T20, self-locking	M4 x 16	3634.430	100
Centre horizontal rails for side panels (HeiPac EASY)	Fastening screw, T20, self-locking	M4 x 12	3634.435	100
- PCBs to PCB holders (die-cast for 3 U), top - PCBs to extractor handles with 6 U	Panhead posidrive screw ISO 7045-4.8-Z-A2K	M2.5 x 8 	3654.320	100
- PCB holder (plastic) to type V/VI handles, bottom - PCBs to PCB holders (plastic) - Backplanes to threaded inserts	Panhead posidrive screw ISO 7045-4.8-Z-A2K	M2.5 x 10 	3654.330	100
- Connectors to Z rails - Z rails to horizontal rails - Type V/VI handles to partial front panels, bottom right for 5 HP - Aluminium guide rails to horizontal rails - Mezzanine front panels	Panhead posidrive screw ISO 7045-4.8-Z-A2K	M2.5 x 6 	3654.340	100
Aluminium guide rails to horizontal rails (fastening of square nuts)	Retaining cage	M2.5	9901.417	100
Handle type V (plastic) to front panels and box-type plug-in units	Mounting kit for type V handle (plastic):		3687.519	1 set
	Cover black Cover grey Hex nut Screw Screw Square nut DIN 562-04-A2K	M2.5 M2.5 x 16 M2.5 x 12 M2.5		
Connectors to PCBs	Panhead posidrive screw ISO 7045-4.8-Z-A2K	M2.5 x 12 	3654.350	100
Guide rails (plastic) to horizontal rails	Screw for plastic WN 1413	M2.2 x 6 	3654.360	100
- Flat front panels to handles type V, VI - Aluminium guide rails to horizontal rails	Square nut DIN 562-A2K	M2.5 	3654.370	100
- Flat front panels to horizontal rails - Trim frame to conceal the front sections of the horizontal mounting kit	Captive screws (cheese-head) and plastic collars	M2.5 x 11 	3658.160	100 sets
Flat front panels	Plastic collars		3687.021	100
PCB to type III handle	Screw for plastic WN 1412	3.0 x 8 	3658.190	100
- PCBs to PCB holders (plastic) - PCB holders to front panels, top	Hex nut ISO 4032-8	M2.5 	3658.210	100
- Backplanes to threaded inserts - Air partitions to horizontal rails	Mounting kit for backplanes:		3684.019	100
	Panhead posidrive screw ISO 7045-4.8-Z-A2K	M2.5 x 6 		
	Washer PE, natural DIN 125	2.7 		
- Covers to mounting blocks - EMC contact strips	Flat csk-screw ISO 7046-1-4.8-Z-A2K	M3 x 6 	3684.233	100
Covers to side panels (Heipac Vario)	Mounting block		3684.234	10
Type V/VI handle to front panels	Bracket		3684.435	100
Ground contact to keyable guide rails	Fastening screw for ground contact	3.5 x 12	3684.109	50
Female connector to PCB attachment	Pop rivet DIN 7340-B-CuZn	2.5 x 0,3 x 10	3684.482	100

Assembly parts

For the attachment of	Description	Dimensions	Order No.	Packs of
Fans to fan mounting plate	Mounting kit for fans:			
	Flat csk-screw ISO 7046-1-4.8-Z-A2K	M4 x 12 	3685.197	1 set
	Hex nut ISO 4032-8	M4 		
Serrated washer DIN 6798-A-Fst-A2K	4.3 			
Covers to side panels	Mounting kit for covers:			
	Mounting block Flat csk-screw ISO 7046-1-4.8-Z-A2K	 M3 x 6 	3685.256	24 sets
PCB holders (die-cast) to front panels, top	Oval csk-screw DIN ISO 7047-4.8-Z-A2K	M2.5 x 8 	3685.282	100
- Covers box-type plug-in units type I/II - Contact/spring sections for 3-part front panels	Flat csk-screw ISO 7046-1-4.8-Z-A2K	M2.5 x 5 	3685.289	100
- Handles on front panels for box type plug-in units - Front panels to hinge strip	Flat csk-screw ISO 7046-1-4.8-Z-A2K	M2.5 x 6 	3685.290	100
Holder (horizontal assembly kit) to horizontal rail	Flat csk-screw similar to DIN ISO 7046-1-4.8-Z-A2K	M2.5 x 5 	3686.916	100
Holder (horizontal assembly kit) to horizontal rail	Flat csk-screw similar to DIN ISO 7046-1-4.8-Z-A2K	M2.5 x 8 	3686.917	100
Contact and spring sections on 3-part front panels without countersink	Panhead posidrive screw DIN ISO 7046-4.8-Z-A2K	M2.5 x 5 	3686.924	100
Set back flanges to side panels	Mounting kit for set back flanges:			
	Panhead self-locking screw similar to DIN ISO 7045-8.8-Z-A2K	M4 x 8 	3687.015	4 sets
	Hex nut ISO 4032-8	M4 		
Washer	4.3 			
Fastening the threaded inserts in horizontal rails	Grub screw ISO 7434-14H	M2.5 x 8 	3687.020	100
- EMC front panels to horizontal rails - EMC trim frame to conceal the front sections of the horizontal mounting kit	Centering screw, slotted	M2.5 x 11 	3687.050	100
EMC front panels to horizontal rails	Centering screw, posidrive	M2.5 x 11 	3687.051	100
EMC front panels to horizontal rails	Centering screw, hex screws	M2.5 x 11 	3688.709	100
Subracks into racks	Panhead screw, posidrive ISO ISO7045-M6x16-4.8-Z-A2K Washer plastic M6	M6 x 16 	2089.000	100
Subracks into racks	Panhead screw, Torx drive ISO 14583 M6x16-4.8-A2K Washer plastic M6	M6 x 16 	7094.600	100
Subracks at the profiles of racks	Cage nut M6 0,8-2,0 with electrical contact	M6 	2094.200	50
Subracks at the profiles of racks	Cage nut M6 0,8-2,0 without electrical contact	M6 	2092.200	50
Front panels and rear panels to horizontal rails	Collar screw, cheese-head, slotted	M2.5 x 11 	3685.097	100
Type V/VI handles (aluminium) to front panels	Mounting kit for type V/VI handles:			
	Panhead posidrive screw ISO 7045-4.8-Z-A2K	M2.5 x 6 	3687.146	1 set
	Bracket			
Square nut DIN 562-11H-A2K	M2.5 			

A photograph of an industrial PC system installed in a metal rack. The system includes a monitor mounted on a shelf, a keyboard and mouse on a pull-out tray, and a front panel with a perforated ventilation grille. The background is a blue-tinted industrial setting.

INDUSTRIAL PC

**Standard solutions and individual assembly –
from plain enclosure to fully integrated industrial PC**

We offer a multitude of Industrial PCs – be it a 19" rack-mount system or solutions for direct installation on mounting plates.

The cases for Industrial PCs shown in this chapter only represent a small sample of HEITEC's wide range of services in this sector. HEITEC offers the solution for Industrial PCs, tailored to your needs, whether it is a non-standard enclosure format or fully integrated Industrial PC system including mother-board, hard disk and input/output boards. Please contact us!

ATX HeiPac, aluminium



The top-of-the-range model with outstanding maintenance-friendliness: The inner housing can be pulled out like a drawer.

ATX 4 U, stainless steel



Lockable front plate to prevent unauthorised access.

ATX with front adaptors



19" version for mounting in the enclosure

AT/ATX (Vario) Economy with frontdoor



Easy de-mounting of disk drive module for external assembly.

INDUSTRIAL PC OVERVIEW HEITEC INDUSTRIAL PC

ATX HeiPac



4 U, aluminium
Order no. see page 208

Applications

- 19" cabinets and enclosures
- Industrial PCs for ATX-, Mini-ATX or Micro ATX boards
- Office- and industrial sector

Technical Specifications

- Enclosure of aluminium, clear-chromated
- Removable inner housing
- Fully assembled and pre-wired
- Including fan and PSU
- EMC prepared
- Electronics for automatic restart following a mains failure

Benefits at a glance

Top-of-the-range aluminium model for installation of an Industrial PC in ATX format. Advantage: outstanding maintenance friendliness. The inner housing can be pulled out like a drawer and thus enables optimum access to all components.

ATX



4 U, stainless steel
Order no. see page 209

Applications

- 19" cabinets and enclosures
- Server enclosures
- Industrial PCs for ATX-, Mini-ATX or Micro ATX boards
- Office- and industrial sector

Technical Specifications

- Enclosure of stainless steel, zinc-plated
- Suitable for mounting on slide rails
- Fully assembled and pre-wired
- Including fan and PSU
- EMC prepared
- Lockable front plate

Benefits at a glance

The neutral design of this system offers a multitude of application areas in the office- or industrial sector. The lockable front plate prevents unauthorised access.

ATX Economy with front door



4 U, stainless steel
Order no. see page 210

Applications

- 19" cabinets and enclosures
- Industrial PCs for ATX-, Mini-ATX or Micro ATX boards
- Industrial sector

Technical Specifications

- Enclosure of stainless steel, zinc-plated
- Hinged, lockable front door
- Suitable for mounting on telescopic slides
- EMC prepared
- Fully assembled and pre-wired
- Including fan and PSU

Benefits at a glance

This solid construction of stainless steel is suitable for extreme industrial environments with high requirements concerning ruggedness and safety. Two versions: ATX Economy, fully assembled and pre-wired or AT/ATX Vario Economy as basic case for individual assembly – for example AT- or ATX applications.

Modular System AT/ATX (Vario) Economy

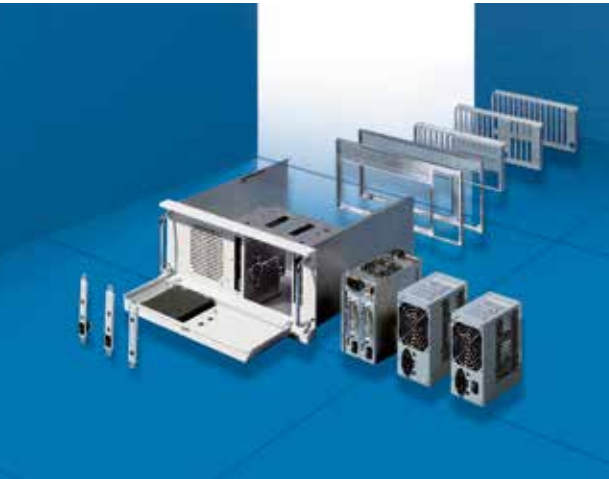

4 U, stainless steel
Order no. see page 211

Applications

- 19" cabinets and enclosures
- Industrial PCs for ATX-, Mini-ATX or Micro ATX boards or AT-/Baby-AT boards
- Industrial sector

Technical Specifications

- Enclosure of stainless steel, zinc-plated
- Hinged, lockable front door
- Suitable for mounting on telescopic slides
- EMC prepared
- Fully assembled and pre-wired including fan and PSU
- Individually upgradeable

Benefits at a glance

The modular principle of AT/ATX Vario Economy allows various installations for individual requirements. The basic case may be fitted for both AT- and ATX applications with the appropriate selection of rear panels, power supply units and front panels. For self-assembly or on request fully assembled and pre-wired.

ATX with front adaptors

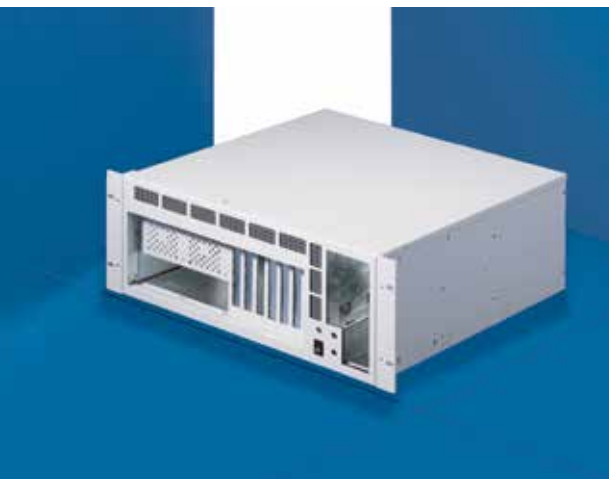

4 U
Order no. see page 212

Applications

- 19" cabinets and enclosures
- Industrial PCs for ATX-, Mini-ATX or Micro ATX boards
- Industrial sector

Technical Specifications

- Enclosure of stainless steel, zinc-plated
- For installation in 19" cabinets
- Suitable for mounting on telescopic slides or on slide rails
- EMC prepared
- Fully assembled and pre-wired
- Including fan and PSU

Benefits at a glance

Flexibility in all application sectors: for example little space, a required connection to other systems or for front access of I/O connections. The 19" version is suitable for installation in cabinets.

ATX with front adaptors for wall-mounting



Width x Height: 380 x 330 mm
Order no. see page 213

Applications

- 19" cabinets and enclosures
- Installation on mounting plates
- Industrial PCs for ATX-, Mini-ATX or Micro ATX boards
- Industrial sector

Technical Specifications

- Enclosure of stainless steel, zinc-plated
- For installation on mounting plates
- Suitable for mounting on telescopic slides or on slide rails
- Fully assembled and pre-wired
- Including fan and PSU

Benefits at a glance

Flexibility in all application sectors: for example little space, a required connection to other systems or for front access of I/O-connections. Flanges on the rear panel for installation on mounting plates.

INDUSTRIAL PC ATX HeiPac

ATX HeiPac 4 U, Aluminium

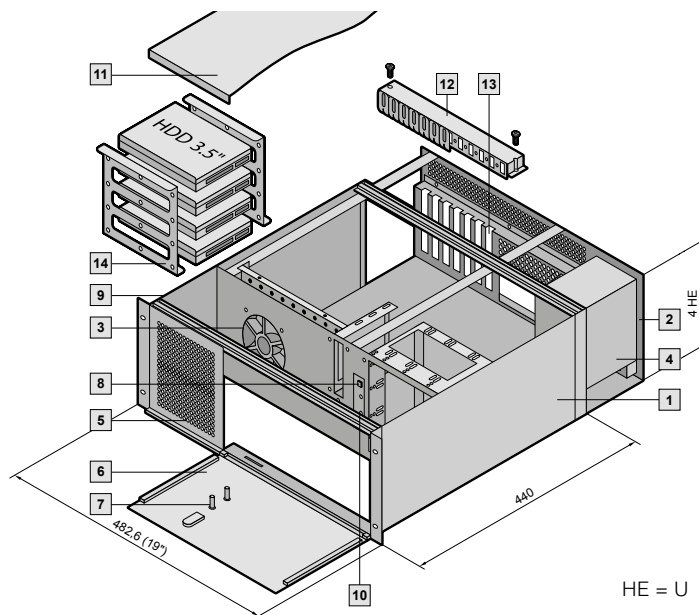

Technical specifications

482.6 mm (19'') rack-mount system for the installation of ATX/Mini-ATX or Micro-ATX boards and 3 x 5 1/4'' and 1 x 3 1/2'' drives.
 Width: 482.6 mm (19'')
 Height 4 U (177.0 mm)
 Total depth: 440 mm
 EMC prepared

Material/surface

Side panels, front panels: Aluminium, clear-chromated
 Covers: 1.0 mm aluminium, clear-chromated
 PC internal cassette: Sheet steel, zinc-plated, passivated

Standards

Complies with IEC 60 297-3 and ATX-specification 2.01

Supply includes

- | | |
|---|--|
| 1 Rack-mount system 4 U including drive holder | 7 LED displays |
| 2 PC cassette | 8 Reset button |
| 3 1 x 120 mm fan with filter | 9 EMC gaskets, all round |
| 4 ATX power pack 350 W | 10 ON/OFF switch with electronics for automatic restart following a mains failure (activation/deactivation of the electronics via jumper) |
| 5 Front door, horizontally hinged | 11 Cover |
| 6 Front door, horizontally hinged, lockable | |

	Packs of		Page
U		4	
Width mm		482,6 (19'')	
Height mm		177.0	
Depth mm		440.0	
Model No. basic system fully assembled	1	3659.000	
Accessories			
12 Card retainer	7	3659.010	215
Mounting bar for card retainer	1	3659.090	215
13 Unused slot cover	5	3659.030	214
Cover for 5 1/4'' drive space	1	3659.050	214
14 Drive support	1 set	3659.060	215

Other customised subrack solutions are available upon request. Please get in contact with one of our sales representatives for further assistance: Tel. +49 9126 - 29 34 0

ATX 4 U, sheet steel

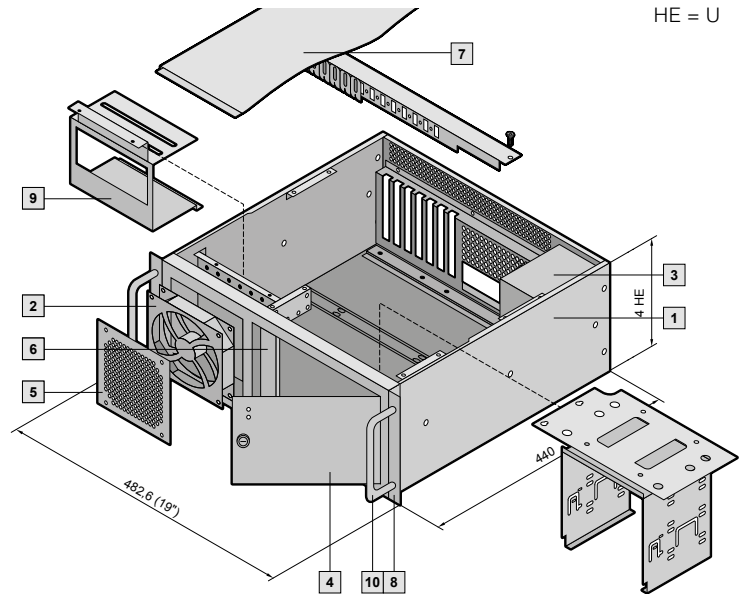

Technical specifications

482.6 mm (19") rack-mount system for the installation of ATX/Mini-ATX or Micro-ATX boards and 3 x 5 1/4" and 1 x 3 1/2" drives.
Width: 482.6 mm (19")
Height 4 U (177.0 mm)
Side panels: 174.0 mm
Total depth: 442.5 mm
Suitable for mounting on slide rails.

Material/surface

Case, covers, front panels: 1.2 mm sheet steel, spray finished in RAL 7035, unpainted contact points

Standards

Complies with IEC 60 297-3 and ATX-specification 2.01

Supply includes

- 1** Rack-mount system 4 U including drive holder
- 2** 1 x 120 mm fan and filter mat, exchangeable from the front
- 3** ATX power pack 350 W
- 4** Front door, vertically hinged, lockable
- 5** Front panel with ventilation holes and filter mat
- 6** LED displays, speakers
Reset switch, on/off switch
- 7** Cover
- 8** Two 19" flanges
- 9** Drive holder for 4 x 3 1/2" hard drives

	Packs of		Page
U		4	
Width mm		482,6 (19")	
Height of flanges/side panels mm		177.0/174.0	
Depth mm		442.5/440.0	
Model No. basic system fully assembled	1	3659.900	
Accessories			
Card retainer	7	3659.010	215
Mounting bar for card retainer	1	3659.090	215
Unused slot cover	5	3659.030	214
Cover for 5 1/4" drive space	1	3659.110	214
Cover for 3 1/2" drive space"	1	3659.410	214
Telescopic slides for 600 mm enclosure depth	1 set	3659.180	214
Telescopic slides for 800 mm enclosure depth	1 set	3659.190	214
10 Front handles for ATX 4 U	2	3659.240	215

Other customised subrack solutions are available upon request. Please get in contact with one of our sales representatives for further assistance: Tel. +49 9126 - 29 34 0

INDUSTRIAL PC ATX ECONOMY

ATX Economy with front door, 4 U, sheet steel

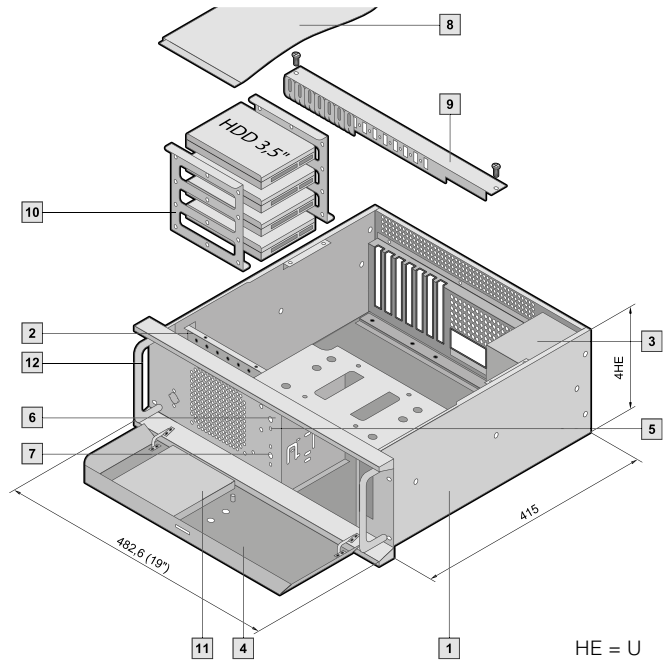

Technical specifications

482.6 mm (19") rack-mount system for the installation of ATX/Mini-ATX or Micro-ATX boards and 3 x 5 ¼" and 1 x 3 ½" drives.
 Width: 482.6 mm (19")
 Height 4 U (177.0 mm)
 Total depth: 430 mm
 EMC prepared

Material/surface

Case, cover: 1.2 mm sheet steel, zinc plated, passivated front door
 1.2 mm, sheet steel spray finished in RAL9035, unpainted contact points

Standards

Complies with IEC 60 297-3 and ATX-specification 2.01

Supply includes

- 1** Rack-mount system 4 U including drive holder
- 2** 1 x 120 mm fan with filter mat
- 3** ATX power pack 350 W
- 4** Front door, horizontally, hinged, lockable
- 5** LED displays, speakers
- 6** Reset button
- 7** On/off switch
- 8** Cover

	Packs of		Page
U		4	
Width mm		482.6 (19")	
Height mm		177.0/174.0	
Depth mm		430.0/415.0	
Model No. basic system fully assembled	1	3659.100	
Accessories			
Card retainer	7	3659.010	215
Mounting bar for card retainer	1	3659.090	215
Unused slot cover	5	3659.030	214
Cover for 5¼" drive space	1	3659.110	214
Cover for 3½" drive space	1	3659.410	214
10 Drive holder	1 set	3659.230	214
11 Spare filter mat	1	3659.120	-
Telescopic slides for 600 mm enclosure depth	1 set	3659.180	214
Telescopic slides for 800 mm enclosure depth	1 set	3659.190	214
12 Front handles for ATX 4 U	2	3659.240	215

Other customised subrack solutions are available upon request. Please get in contact with one of our sales representatives for further assistance: [Tel. +49 9126 - 29 34 0](tel:+49912629340)

Modular system AT/ATX Vario Economy with front door, 4 U, sheet steel

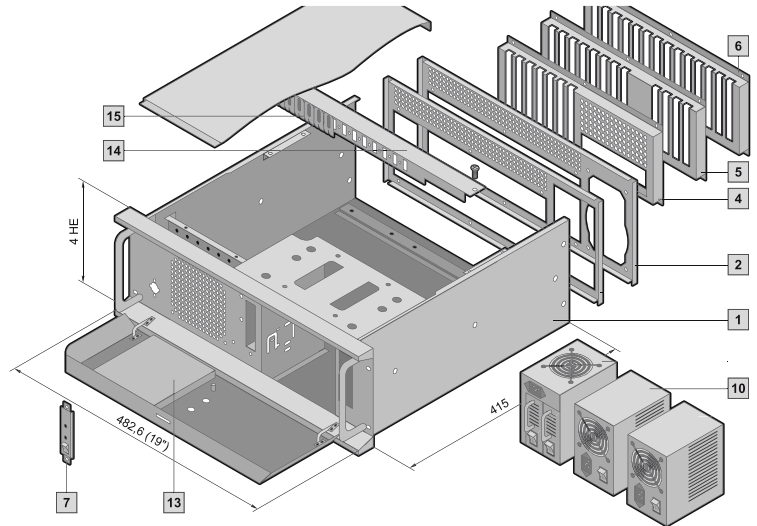

HE = U

The modular principle of AT/ATX Vario Economy allows installation to accommodate individual requirements. The basic case may be fitted for both AT and ATX applications with the appropriate selection of rear panels, power packs and front trim panels. For self-assembly, or on request fully assembled and wired.

Technical specifications

482.6 mm (19") rack-mount system for the installation of ATX/Mini-ATX, Micro-ATX or Baby AT boards and 3 x 5¼" and 1 x 3½" drives.
Width: 482.6 mm (19")
Height: 4 U (177.0/174.0 mm)
Total depth: 430 mm

Note

Rear panel, front trim panel and power pack should be ordered separately (for self-assembly).

Material/surface finish

Case, cover: 1.2 mm sheet steel, zinc-plated, passivated
Front door: 1.2 mm sheet steel, spray-finished in RAL 7035, unpainted contact points

Standards

Complies with IEC 60 297-3 and ATX specification 2.01

Special designs available on request

Basic enclosure supply includes

- 1 Case 4 U, 430 mm deep including assembly parts, covers, drive holder, fan, horizontally hinged front door, and air filter.

	Packs of							Page
U		4						
		Installation for AT/ATX power pack (PS/2)			Installation for redundant power pack (PS/2)			
		ATX	AT 8 + 4 slot	AT 14 slot	ATX	AT 8 + 4 slot	AT 14 slot	
Model No. basic enclosure fitted	1	3659.400						
Installation, rear								
2 Rear panel for AT/ATX power pack	1	3659.290	3659.290	3659.290	-	-	-	216
4 Slotted rear panel for ATX 7 slots	1	3659.320	-	-	3659.320	-	-	217
5 Slotted rear panel 8 + 4 slots for AT	1	-	3659.330	-	-	3659.330	-	217
6 Slotted rear panel 14 slots for AT	1	-	-	3659.340	-	-	3659.340	217
Installation, front								
7 Front trim panel ATX with 2 x LED, reset switch	1	3659.350	-	-	3659.350	-	-	214
Power packs								
10 ATX power pack 350 W FSP350-70PFL	1	9921.966	-	-	-	-	-	
Fan 12 V DC, 60 mm, for the rear panel	2	3659.250	3659.250	3659.250	3659.250	3659.250	3659.250	216
13 Spare filter mat	1	3659.120	3659.120	3659.120	3659.120	3659.120	3659.120	-
Accessories								
14 Mounting bar for card retainer	1	3659.090	3659.090	3659.090	3659.090	3659.090	3659.090	215
15 Card retainer	7	3659.010	3659.010	3659.010	3659.010	3659.010	3659.010	215

Other customised subrack solutions are available upon request. Please get in contact with one of our sales representatives for further assistance: Tel. +49 9126 - 29 34 0

INDUSTRIAL PC ATX WITH FRONT ADAPTORS

ATX with front connections for 482.6 mm (19") installation, 4 U

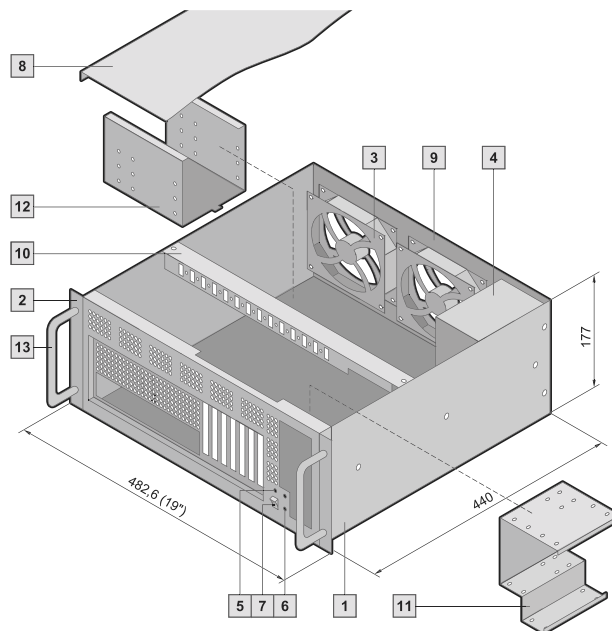

Technical specifications

482.6 mm (19") rack-mount system for the installation of ATX/Mini-ATX or Micro-ATX boards and 1 x 5¼" and 1 x 3½" drives.
 Width: 482.6 mm (19")
 Height: 4 U
 Flanges: 177.0 mm
 Side panels: 174.0 mm
 Total depth: 442.5 mm
 Connections for I/Os, front
 EMC prepared. Suitable for mounting on slide rails

Material/surface finish

Case, covers: 1.2 mm sheet steel, spray-finished in RAL 7035, unpainted contact point

Supply includes

- | | |
|---|---|
| 1 Rack-mount system 4 U including drive holder | 8 Cover |
| 2 19" flanges | 9 Rear panel with cutout and connection for power pack |
| 3 2 x 120 mm fans | 10 Mounting bar for card retainer |
| 4 ATX power pack 350 W | 11 Drive holder for 1 x 5¼" and 1 x 3½" |
| 5 LED displays | 12 Drive holder for 3 x 3½" and hard drives |
| 6 Reset button | |
| 7 On/off switch | |

Standards

Complies with IEC 60 297-3 and ATX specification 2.01

	Packs of		Page
U		4	
Width mm		482.6 (19")	
Height of flanges/side panels mm		177.0/174.0	
Depth mm		442.5/440.0	
Model No. basic system fully assembled	1	3659.700	
Accessories			
Card retainer	7	3659.010	215
Unused slot cover	5	3659.030	214
Cover for 5¼" drive space	1	3659.110	214
Cover for 3½" drive space	1	3659.410	214
Telescopic slides for 600 mm enclosure depth	1 set	3659.180	214
Telescopic slides for 800 mm enclosure depth	1 set	3659.190	214
13 Front handles for ATX 4 U	2	3659.240	215

Other customised subrack solutions are available upon request. Please get in contact with one of our sales representatives for further assistance: Tel. +49 9126 - 29 34 0

ATX with front adaptors for wall-mounting

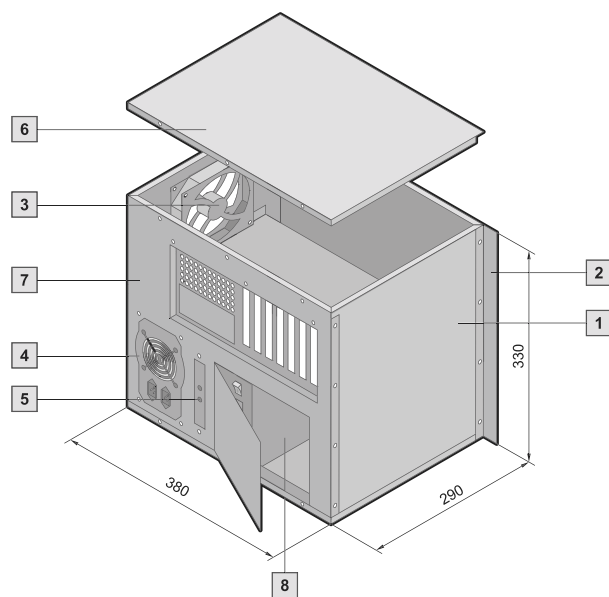

Technical specifications

System for the installation of ATX/Mini-ATX or Micro-ATX boards and 3 x 5¼" and 1 x 3½" drives, vertical.

Height: 330 mm

Total depth: 292.5 mm

Connections for I/Os, front

EMC prepared.

Suitable for mounting

Suitable for mounting on mounting plates

Material/surface finish

Case, covers: 1.2 mm sheet steel, zinc-plated, passivated, unpainted, unpainted contact points

Supply includes

1 Rack-mount system including drive holder

2 Flanges for wall mounting

3 1 x 120 mm fan

4 ATX power 350 W

5 LED displays

6 Cover

7 Front panel

8 Drive holder for 1 x 5¼" and 1 x 3½"

Standards

Complies with IEC 60 297-3 and ATX specification 2.01

	Packs of		Page
Width mm		380.0	
Height mm		330.0	
Depth mm		292.5/290.0	
Model No. basic system fully assembled	1	3659.710	
Accessories			
Unused slot cover	5	3659.030	214
Cover for 5¼" drive space	1	3659.110	214
Cover for 3½" drive space	1	3659.410	214

Other customised subrack solutions are available upon request. Please get in contact with one of our sales representatives for further assistance: Tel. +49 9126 - 29 34 0

Unused slot cover



Screw-on cover to conceal slot cut-outs which are not required.

Packs of	Order No.
5	3659.030

Material

Sheet steel
Clear-chromated

Supply includes

Assembly parts

Cover for drives



To conceal the 3/2" or 5/4" drive slots.

Material

Sheet steel
Zinc-plated, spray-finished in RAL 7035

Supply includes

Assembly parts

Design	Packs of	Order No.
3/2"	1	3659.410
5/4"	1	3659.110

For ATX HeiPac

Design	Packs of	Order No.
5/4"	1	3659.050

Telescopic slides



Facilitate optimum accessibility to the units, even when built-in.
For up to a maximum enclosure width of 426 mm.

Load capacity

30 kg

Material

Sheet steel

Supply includes

1 set = 2 telescopic slides
Installation kit
Assembly parts

For enclosure depth mm	Max. extension mm	Order No.
600	511.2	3659.180
800	596.4	3659.190

! Note

Only applicable in connection with L-shaped 19" profiles

Front handles



The handles are fitted onto the 482.6 mm (19") flanges. They allow easy withdrawal of the cases from the enclosure.

Material

Sheet steel
Plated

Supply includes

Assembly parts

For enclosure height (U)	Packs of	Order No.
1	2	3659.540
2	2	3659.020
4	2	3659.240

Drive holder



The drive holder will accommodate a maximum of 4 additional 3½" hard disks. They are mounted inside the enclosure behind the fan.

Material

Sheet steel
Zinc-plated

Supply includes

Assembly parts

For system	Packs of	Order No.
ATX Economy	1 set	3659.230
ATX HeiPac	1 set	3659.060

Card retainer



For secure attachment and stabilisation of slot cards up to 327 mm depth. The card retainers are height-adjustable so that even cards of different heights may be securely attached.

A mounting bar is needed to fit the card retainer (already included with ATX HeiPac).

Material

Card retainer: Plastic
Mounting bar: Sheet steel, zinc-plated

Supply includes

7 Card retainer 41 mm
3 Card retainer 28.3 mm
1 Extension long 86.2 mm
1 Extension short 56.8 mm

Card retainer		Order No.
Packs of		
1 set		3659.010

Mounting bar		Order No.
Packs of		
1		3659.090

Adaptor



For the installation of 3 1/2" hard disks or floppies in 5 1/4" installation slots.

Material

Sheet steel, zinc-plated
Front panel: Spray-finished in RAL 7035

Supply includes

Assembly parts

Design	Packs of	Order No.
for 3 1/2" hard disk	1	3659.270
for 3 1/2" floppy	1	3659.280

DC fan for rear panel



Fan 12 V DC, 60 mm, for mounting on the rear panel. Including two 4-pole connectors with terminal.

Supply includes

2 fans with connection cable
Including assembly parts.

Packs of	Order No.
2	3659.250

Rear panels



For the installation of AT/ATX Economy. Optionally with cut-out for AT/ATX power pack or redundant power pack.

Material

Sheet steel
Zinc-plated

Supply includes

Assembly parts

Design	Packs of	Order No.
for AT/ATX PS2 and redundant power supply	1	3659.290

Slotted rear panels

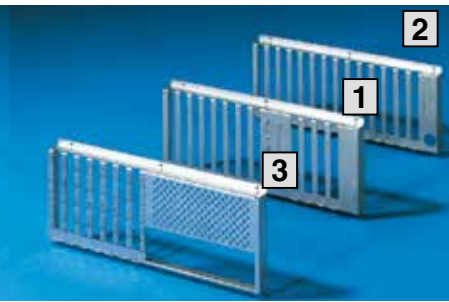

For the installation of AT/ATX Economy.
Mounted on the rear panels. Optionally for
AT (8 + 4 or 14 slots) or ATX (7 slots).

Material

Sheet steel
Zinc-plated

Supply includes

Assembly parts

Design	Packs of	Order No.
1 AT 4 + 8 Slot	1	3659.330
2 AT 14 Slot	1	3659.340
3 ATX 7 Slot	1	3659.320

Front trim panels



For the installation of AT/ATX Economy.
Mounted in the front of the enclosure.

Optionally for:

- ATX (2 x LED, reset button)

Design	Packs of	Order No.
ATX	1	3659.350



HEITEC SYSTEM PLATFORMS

Standardised components
for individual application possibilities

SYSTEM PLATFORMS

HEITEC supplies complete plug & play solutions for several application possibilities at a high level – up to Level 5. The systems are based on standardised components which may be individually combined, depending on requirements.

They are supplied completely with power supply, backplane, measures for EMC and ESD protection, as well as climate control; fully assembled, pre-wired and tested.

MicroTCA, AdvancedMC



→ Page 222

CompactPCI



→ Page 230

CompactPCI Serial



→ Page 242

VME/VME64x



→ Page 244

Backplanes



→ Page 252

MPS Monitoring



→ Page 255

SYSTEM PLATFORMS

OVERVIEW MicroTCA / TCA

MicroTCA – compact package, wide range of applications



As an amendment to the AdvancedTCA standard, the MicroTCA specification mTCA.x was created as a compact version for a variety of applications. MicroTCA offers standardised modularity, compact design and a high scalability and bandwidth.

Additionally, the consistent platform strategy reduces the time to market. Whenever ultra fast data transmission or data storage is required, MicroTCA systems are the first choice. This is true not only for telecom applications but also for industrial control systems or medical engineering.



HEITEC ELECTRONIC PACKAGING SYSTEMS offers the “complete know-how” for professional Electronic Packaging – for MicroTCA-, CPCI-, VME- and customer specific applications.

Our range of services comprises complete “plug & play”- systems including backplanes, power supply and effective cooling units.

xTCA™ AdvancedMC™

MicroTCA development system VP1 single/double



3/5 U, 12 slots
Order no. see page 222

Applications

MicroTCA specification is designed as an amendment to the ATCA standard as a lower-cost compact version for the low-end sector. The main features are a compact design, high scalability, modularity and considerably reduced system costs.

MicroTCA development systems are suited for design of hardware software or for testing AMC modules.

Technical specifications

- 19" rack-mount system 3 or 5 U, 200 mm deep
- For installing single (3 U) or double (5 U) AMC modules
- 12 x AMC slots (8 x full, 4 x compact)
- 2 x MCH slots
- 2 x Power slots
- Integrated power adapter
- Fan unit for cooling up to 40W/slot
- Backplane 14 slots
- Support brackets

Benefits at a glance

- Conforms to PICMG MicroTCA.0 R1.0 and AMC.0 R2.0
- Integrated fan unit
- Integrated power adapter
- Fully wired and tested

MicroTCA rack-mount system VP1 single/double



2/4 U, 12 slots
Order no. see page 222

Applications

MicroTCA specification is designed as an amendment to the ATCA standard as a lower-cost compact version for the low-end sector. The main features are a compact design, high scalability, modularity and considerably reduced system costs. The rack-mount systems are suited for applications in the low-end telecommunication or industrial sectors.

Technical specifications

- 19" rack-mount system 2 (+10 mm) or 4 U, 200 mm deep
- For installing single (2 U) or double (4 U) AMC modules
- 12 x AMC slots (8 x full, 4 x compact)
- 2 x MCH slots
- 2 x Power slots
- Backplane 14 slots

Benefits at a glance

- Conforms to PICMG MicroTCA.0 R1.0 and AMC.0 R2.0
- Fully wired and tested

CubeTCA

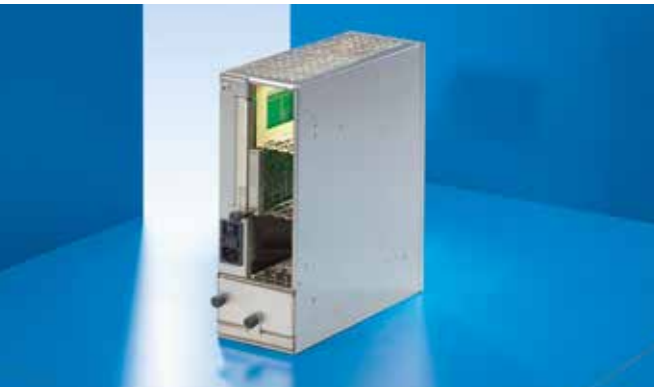

7 slots
See page 224

Applications

Based on the MTCA specification the compact CubeTCA offers a wide range of application fields in the industrial sector. The CubeTCA can either be assembled directly on the mounting plate or integrated within the target system.

Technical specifications

- Frame 109 x 307 x 286 mm
- 7 slots – 6 x AMC, 1 x MCH
- Removable cooling unit with two axial-flow fans and filter
- AC/DC power supply, 350 W
- Optional brackets for assembly on mounting plates
- Optional adapter for cap rail installation

Benefits at a glance

- Conforms to MicroTCA.0 R1.0
- Compact design
- Assembly on mounting plate or in the target system
- Plug-in fan unit
- 7 slots
- Fully assembled, wired and tested

PicoTCA



2 U, 13 slots
Order no. see page 223

Applications

Based on the MTCA specification, PicoTCA is a modular ready-to-run system, which carries up to 12 AMCs and 1 MCH. Due to the robust construction, the 19" rack can be used both in the telecommunication and in the industrial sector.

Technical specifications

- 19" rack-mount system, 2 U, 250 mm deep
- Supports 12 AMCs (full-size, compact) and 1 MCH
- Cooling via 2 stand-alone cooling units with removable air filter
- EMC version
- AC/DC power supply: 450 W
- Backplane and AMC-connector in con:card+ quality from HARTING
- Integrated JTAG-connector for debug and test
- Support up to 12.5 Gb/s

Benefits at a glance

- Conforms to PIGMG MicroTCA.0 R1.0
- Ready-to-run system of minimum space
- For installation in 300 mm deep enclosures
- Support up to 12.5 Gb/s
- Removable air filter
- Robust industrial model guarantees shock and vibration protection
- Compliant to NEBS
- Fully assembled, wired and tested

MicroTCA – compact package, wide range of applications



MicroTCA development systems for hardware and software development or testing of AMC modules

Technical specifications

- Complies with PICMG Micro-TCA.0 R1.0 and AMC.0 R1.0
- 482.6 mm (19") development systems in 3 and 5 U, 200 mm deep for installing Single or Double AdvancedMC modules
- Integral fan unit for cooling up to 40 W/slot
- Including backplane, 14 slots
- Fully wired and tested



MicroTCA rack-mounted system for applications in the low-end telecommunications and industry sectors.

Technical specifications

- Complies with PICMG Micro-TCA.0 R1.0 and AMC.0 R1.0
- 482.6 mm (19") rack-mount systems in 2 and 4 U, 200 mm deep for installing Single or Double AdvancedMC modules
- Including backplane, 14 slots (complies with MTCA.0 R1.0)
- Fully wired and tested
- Order climate control units separately

Material

Rack-mount systems of sheet steel, zinc-plated, sprayfinished

Supply includes

1 482.6 mm (19") system, 200 mm deep,
1 backplane

For additional development system:

1 fan unit
2 support brackets

Note

Power Module has to be ordered separately, see page 225.
For 4 or 5 U systems you may optionally order a 6 HP divider rail in order to cover the free space above the power module.

MicroTCA development systems

µTCA system	U	AMC-Slots	MCH-Slots	Power-Slots	Order No.
VP 1 single	3	12 (8 x full, 4 x compact)	2	2	3666.006
VP 1 double	5	12 (8 x full, 4 x compact)	2	2	3666.007

Power modules available on request.

MicroTCA rack-mount systems

µTCA system	U	AMC-Slots	MCH-Slots	Power-Slots	Order No.
VP 1 single	2 (+10 mm)	12 (8 x full, 4 x compact)	2	2	9911.758
VP 1 double	4	12 (8 x full, 4 x compact)	2	2	9911.760

PicoTCA, 19", 2 U



The PicoTCA is a modular 19" chassis in 2 U design supporting up to 12 AMC's (fullsize, compact) and an MCH (fullsize). The chassis is designed such that communication protocols compliant with AMC.1 type 4 (PCIe and Advanced Switching), AMC.2 type 4, AMC.2 E2 (GbE) and AMC.3 (SAS/SATA) can all be handled. For SAS and SATA/AMC boards, a point-to-point connection is realised via the backplane, so that each slot is able to communicate directly with its neighbouring slots via ports 2 and 3. In the initial version, an MCH (Micro-TCA Carrier Hub) is supported via the backplane. Customer-specific designs and backplanes can be supplied upon request.

Benefits at a glance

- Conforms to PICMG Micro-TCA.0 R1.0
- Extremely compact ready-to-run system
- Chassis depth of 250 mm for installation in 300 mm deep enclosures
- Includes AC/DC power supply
- Support for up to 12.5 Gb/s
- Support for different AMC form factors
- Exchangeable air filters
- High EMC shielding
- Robust industrial design
- Fully assembled, wired and tested. Ready to run

Technical specifications

- 19", 2 U, 250 mm deep
- AC/DC power supply, max. 450 W:
 - Input voltage: min. 90 V AC – max. 264 V AC with PFC
 - Input frequency: min. 47 Hz – max. 63 Hz
 - Output: 3.3 V DC/max. 3 A, 12 V DC/max. 38 A
- Cooling via 2 independent fan trays
- Backplane and AMC connectors in con:card+ quality from HARTING
- Integrated JTAG connector for debug and test
- Supports 12 AMC's (full-size, compact) compliant with AMC.1 type 4 E2S and AMC.2 type 4 E2S, as well as 1 MCH
- Weight: 5.9 kg
- Operating temperature: 0°C to +45°C
- Storage temperature: -40°C to +85°C

Supply includes

- 1 rack-mount system 482.6 mm (19"), 2 U, 250 mm deep,
- 2 fan tray modules with air filters,
- 1 power supply,
- 1 backplane,
- 1 power management board

	Packs of	2 U
Width (W)		19"
Height (H) mm		87
Depth (D) mm		250
Order No.	1	9911.803

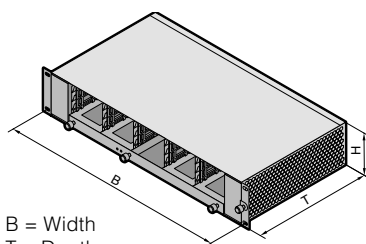

B = Width
T = Depth
H = Height

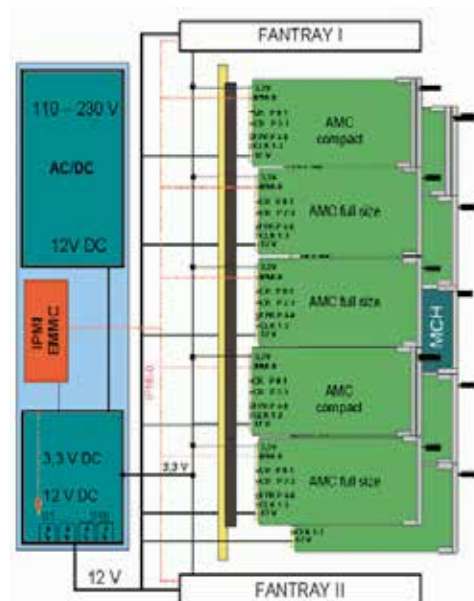

SYSTEM PLATFORMS

MicroTCA – CubeTCA

CubeTCA



Due to the compact dimensions the cubeTCA platform offers a huge variety of applications in the industrial sector. Assembly on mounting plate or in the target system by using integrated key holes or adapters for assembly directly on support rails.

Benefits at a glance

- Conforms to MicroTCA.0 R1.0
- Compact design
- Assembly on mounting plate or in the target system
- 7 slots for 6 x AMC, 1 x MCH
- Plug-in fan unit with 2 axial flow fans and filter
- Integrated AC/DC power supply
- Fully assembled, wired and tested

Technical specifications

- 6 front slots
- Backplane 6 slots inclusive
- Removable cooling unit
- AC/DC power supply: 350 W

Material

Stainless steel

Supply includes

1 system

Note

Available on request

+ Accessories

Brackets for assembly on mounting plates
Top hat rails for installation on support rails

B = Width
T = Depth
H = Height

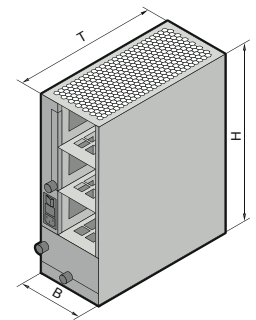

Technical details



Installation space

For 6 AMC, 1 x MCH



Cooling unit and filter,

Removable

Accessories on request



Top hat rails

For installation on support rails.



Brackets

For rear or lateral assembly on mounting plates.

Power Module PM



The PM is a 355 W MicroTCA PowerModule in Advanced Mezzanine Card (AMC) form factor, single/full-size compliant to MTCA.0 specification. The Power Module comprises an Enhanced Module Management Controller (EMMC) that communicates with the Carrier Manager via Intelligent Platform Management Bus (IPMB).

Technical specifications

- Power supply for MicroTCA Carrier Hub (MCH) AdvancedMCs and Cooling Units (CU)
- Operates via IPMI with a MicroTCA Carrier Hub (MCH)
- Power monitoring of each channel
- 16 x 12 volt channels for Payload Power
- 16 x 3.3 Volt channels for Management Power
- EMC- filter, transient protection, input current lock-out

Description	Order No.
PM 355W/-48V	3666.008

Technical Details

- 355 W
- – 48 VDC Input
- 12 VDC Output
- 3.3 VDC Output

SYSTEM PLATFORMS

AdvancedMC – FACE PLATES

AMC Face Plate Kits



These are used as face plates for AMC cards and ATCA carriers, or as filler panels in MicroTCA systems.

- Installation in μ TCA systems or AMC carriers
- Conforms to AMC.0 R2.0
- Height: Single & Double
- Widths: Compact, Mid-Size, Full-Size
- Simple handling when locking and unlocking (no screws)
- Hot swap-compatible injector/extractor handles
- Customer-specific face plates available with a short lead time
- Upgradable with filler sheets and air baffle plates
- Double to Single conversion module (accessory)

Material

Face plate made from aluminium, (stainless steel available on request)
 Holder for light pipe and PCB, die-cast zinc
 Light pipe, polycarbonate
 Handle, die-cast zinc, spray-finished
 EMC seal, foam with metal fabric (UL 94 - V0)

Supply includes

- 1 U-channel face plate,
- 1 holder to accommodate a light pipe and PCB,
- 1 handle for microswitch,
- 1 light pipe (for 2 LEDs),
- 1 EMC gasket, left side and bottom

Design (H x W)	Packs of	Order No.
Single x Compact	1	9911.885
Single x Mid-Size	1	9911.889
Single x Full-Size	1	9911.886
Double x Compact	1	9911.887
Double x Mid-Size	1	9911.890
Double x Full-Size	1	9911.888

Face plates with 4 LEDs in aluminium and stainless steel available on request (to AMC.0 Spec. R1.0)

+ Accessories

AMC filler sheets, air baffle plates, conversion module, see page 227

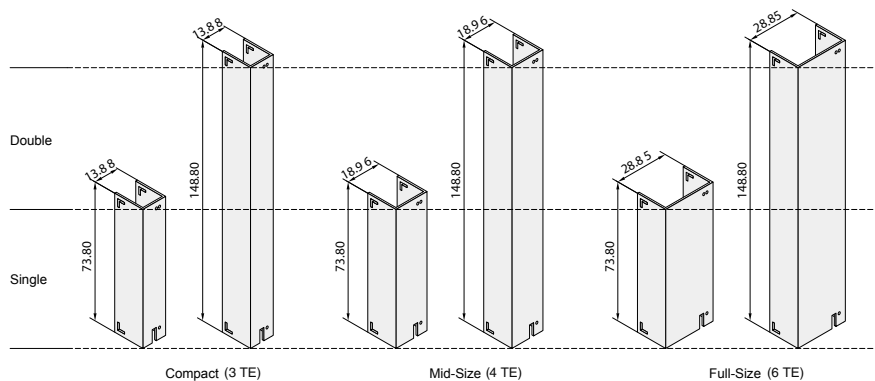
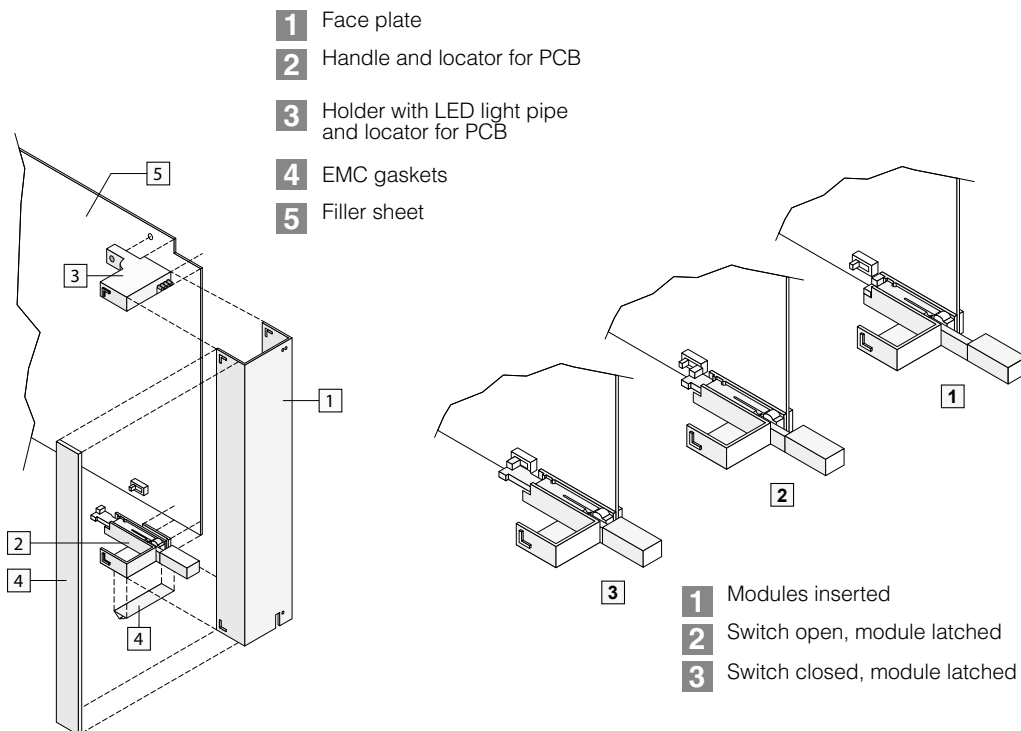

AMC filler sheets



Filler sheets are mounted on the AMC face plates and are used to route the airflow in ATCA carriers and MicroTCA systems.

They may additionally be equipped with air baffle plates to create suitable air resistance in an empty slot.

Material

Epoxy

Design	Packs of	Order No.
Single	1	9911.570
Double	1	9911.571



Air baffle plates



AMC slots must be populated with an empty card in order to ensure adequate air resistance. The air resistance should be adapted to the requirements of the overall system by the user. In all cases, it should be sufficiently high to ensure that the air is forced to flow over active cards into adjacent slots and does not flow unhindered through empty slots. The air baffle plate is used to adjust the air resistance. Up to 2 air baffle plates may be mounted on one filler sheet. Adjustable air resistance from 80 – 50 % thanks to removable membranes.

Material

Stainless steel

Supply includes

1 baffle plate
Assembly parts

Design	Packs of	Order No.
Compact	1	9911.891
Mid-Size	1	9911.892
Full-Size	1	9911.893



Conversion module



The conversion module allows 1 x Double to be converted into 1 x Single slot. Option of installing Compact or Full-Size modules.

Material

Stainless steel, partially spray-finished

Supply includes

1 conversion module

Design	Packs of	Order No.
Compact	1	9907.699
Full-Size	1	9911.220



SYSTEM PLATFORMS

RACK-MOUNT SYSTEMS FOR CompactPCI, CompactPCI SERIAL, VMEbus



CompactPCI®

CompactPCI® Serial



RACK-MOUNT SYSTEMS FOR CompactPCI, CompactPCI SERIAL, VMEbus

**EMC Features**

All components have a conductive surface: stainless steel EMC gaskets connect to the individual components. EMC front panels with EMC gaskets ensure proper contacting.

**ESD Protection**

ESD pin and ESD Clip in the guide rail deflect electrostatic charging before contacting the plug in unit. ESD Clip in the PCB guide rail provides permanent and direct deflection via the PCB.

**Ventilation**

Small card guides and horizontal rails ensure maximum air flow. Individual ventilation concepts provide well directed air ducting and ideal heat dissipation - optionally from bottom to top or from front to rear. Powerful HeiCool fan ensures optimum climate control. 1 U, hot swap compatible, 204 m³ /h including speed control and fault alarm signal.



**Systems for
CompactPCI**



**Systems for
CompactPCI Serial**



**Systems for
VME/VME64x**

BENEFITS AT A GLANCE

- Systems for setup of industrial computer systems according to CompactPCI specification and VME bus
- Robust mechanics
- Individual configuration on request
- Completely assembled, pre-wired and tested including backplane and power supply
- Individual cooling concepts
- Conforms to IEC 60 297-3 and IEEE 1101.1/10/11 and Compact PCI spec. rev.1.0 (PICMG)

SYSTEM PLATFORMS OVERVIEW RACK-MOUNT SYSTEMS FOR CompactPCI

CPCI-Systems Slim-Box Vario



1, 2, 3, 4 U/2, 4, 6, 8 slots
Order no. on request

Applications

Configuration of 19" industrial computer systems according to CompactPCI specification for

- Telecommunication
- Industrial Automation

Technical specifications

- 482.6 mm (19") rack-mount system for horizontal mounting of front boards or rear I/O boards
- 1 U, 2 U, 3 U, 4 U, 300 mm deep
- Standard cooling from left to right side
- Sheet steel, spray-finished (black)
- Preconfigured system including backplane and fan unit
- Completely assembled, pre-wired and tested
- Installation of CPCI-boards according to CompactPCI spec. 2.0 Rev. 3.0

Benefits at a glance

- Horizontal installation of Eurocards/Double Eurocards
- Maximum installation with minimum space requirement
- 2/4/6/8 front slots for 160 mm and back slots for 80 mm boards
- Hot-swap compatible power supplies , optionally AC or DC
- EMC and ESD protection
- Completely assembled, pre-wired and tested
- Integrated cooling from left to right
- Modular assembly for individual configuration
- Corresponds to CompactPCI spec. 2.0 rev. 3.0, IEC 60 297-3-101, - 102, - 103

HeiPac CPCI-Systems



3 U, 5 slots/4U, 7 slots horizontal
Order no. see page 232

Applications

Configuration of 19" industrial computer systems according to CompactPCI specification for

- Telecommunication
- Industrial Automation

Technical specifications

- 482.6 mm (19") rack-mount system for horizontal mounting of double Eurocards
- 3 U, 4 U, 405 mm deep
- Aluminium coated
- Including backplane, power supply and fan unit on the rear panel
- Completely assembled, pre-wired and tested
- Horizontal installation space for double Eurocards: 5 and 7 slots
- Installation of CPCI boards according to CompactPCI spec. 2.0 rev. 3.0

Benefits at a glance

- Horizontal installation of double Eurocards
- EMC and ESD protection
- Completely assembled, pre-wired and tested
- Well-directed air ducting from front to rear by fans in the rear panel
- Keyable guide rails
- Corresponds to CompactPCI spec. 2.0 rev. 3.0, IEC 60 297-3-101, - 102, - 103

HeiPac CPCI-Systems



7 U, 8 slots
Order no. see page 234

Applications

Configuration of 19" industrial computer systems according to CompactPCI specification for

- Telecommunication
- Industrial Automation

Technical specifications

- 482.6 mm (19") rack-mount system for vertical mounting of double Eurocards
- 7 U, 405 mm deep
- Aluminium coated
- Including backplane, power supply and fan unit on the rear panel
- Completely assembled, pre-wired and tested
- Installation space for boards: 8 slots
- Installation of CPCI boards according to CompactPCI spec. 2.0 rev. 3.0

Benefits at a glance

- Vertical installation of double Eurocards
- EMC and ESD protection
- Completely assembled, pre-wired and tested
- Well-directed air flow from front to rear by DC fans on the rear panel
- Keyable guide rails
- Conforms to CompactPCI spec. 2.0 rev. 3.0, IEC 60 297-3-101, - 102, - 103

HeiPac CPCI-Systems



4 U/7 U, 8 slots
Order no. see page 233

Applications

Configuration of 19" industrial computer systems according to CompactPCI specification for

- Telecommunication
- Industrial Automation

Technical specifications

- 482.6 mm (19") rack-mount system for vertical mounting of Eurocards/double Eurocards
- 4 U and 7 U, 405 mm deep
- Aluminium coated
- Including backplane and power supply
- Fan unit with 3 DC fans
- Completely assembled, pre-wired and tested
- Installation space for Eurocards/double Eurocards: 8 slots
- Installation of CPCI boards according to CompactPCI spec. 2.0 rev. 3.0

Benefits at a glance

- Vertical installation of Eurocards/double Eurocards
- EMC and ESD protection
- Completely assembled, pre-wired and tested
- Fan unit provides directed air flow from bottom to top
- Keyable guide rails
- Conforms to CompactPCI spec. 2.0 rev. 3.0, IEC 60 297-3-101, - 102, - 103

HeiPac CPCI-Systems



9 U, 8 slots with HeiCool and Rear I/O
Order no. see page 235

Applications

Configuration of 19" industrial computer systems according to CompactPCI specification for

- Telecommunication
- Industrial Automation

Technical specifications

- 482.6 mm (19") rack-mount system for vertical mounting of double Eurocards
- 9 U, 290.5 mm deep, on the rear side for I/O modules
- Aluminium coated
- Including backplane, power supply and 2 radial fans HeiCool (204 m³/h)
- Completely assembled, pre-wired and tested
- Installation space for boards: 8 slots
- Installation of CPCI boards according to CompactPCI spec. 2.0 rev. 3.0

Benefits at a glance

- Vertical installation of double Eurocards
- EMC and ESD protection
- Completely assembled, pre-wired and tested
- Well-directed air flow from front to rear
- Rear I/O
- Keyable guide rails
- Effective ventilation by 2 radial fans HeiCool (204 m³/h)
- Conforms to CompactPCI spec. 2.0 rev. 3.0, IEC 60 297-3-101, - 102, - 103

SYSTEM PLATFORMS

RACK-MOUNT SYSTEMS FOR CompactPCI

HeiPac 3 U, 5 slots/4 U, 7 slots horizontal

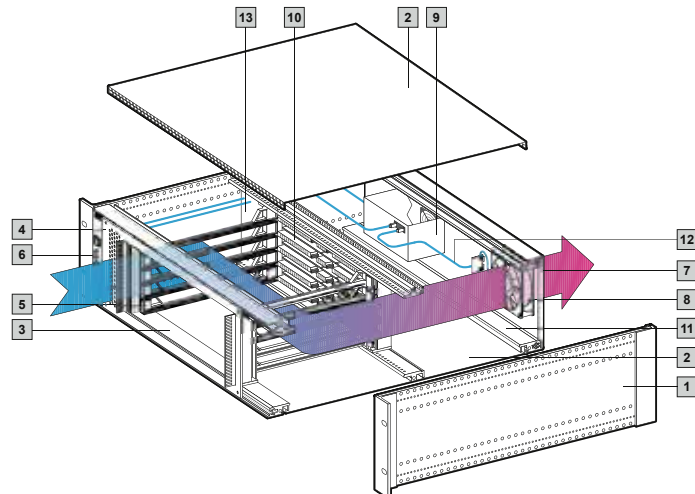

Technical specifications

Subrack, 405 mm deep, for installation in 482.6 mm (19") enclosures or cases. Prepared to accommodate CPCI boards and drives. Includes MPS Monitoring (see pages 255 ff.) Complies with IEC 60 297-3-101, -102, -103. Fully assembled, pre-wired and tested.

Illustration

MPS system 3 U for CPCI

U	3	4	Page
Side panel depth mm	405	405	
Wiring space (depth in mm)	210	210	
For PCB	6 U x 160 mm	6 U x 160 mm	
MPS system Model No.	9910.944	9910.945	
Mechanical supply includes			
Description	Material	Qty.	
1 HeiPac basic subrack system (side panels, horizontal rails, flanges, EMC gaskets)	Aluminium, clear-chromated/stainless steel	1	1
2 Top and bottom covers, solid	Aluminium	2	2
13 Air partition	Aluminium	1	1
EMC shielding plate for fan	Aluminium, clear-chromated	1	1
3 Horizontal mounting kit	Aluminium, clear-chromated	1	1
4 Trim frame for horizontal mounting kit	2.5 mm aluminium, clear-chromated	1	1
5 Plastic guide rails, keyable	Polycarbonate UL 94-V0	8	12
Plastic guide rails, keyable, red	Polycarbonate	2	2
6 EMC front panel 3 U/5 HP for MPS monitoring	2.5 mm aluminium, clear-chromated	1	-
EMC front panel 4 U/5 HP for MPS monitoring	2.5 mm aluminium, clear-chromated	-	1
7 EMC rear panel 3 U/84 HP with fan and connector cut-out	2.5 mm aluminium, clear-chromated	1	-
EMC rear panel 4 U/84 HP with fan and connector cut-out	2.5 mm aluminium, clear-chromated	-	1
Electrical/electronic supply includes			
Description	Technical specifications		
8 DC fan	12 V DC, 48 m ³ /h, per fan (UL, CSA, VDE) optionally speed-controlled	1	1
9 Power supply unit ATX, PS/2	300 W	1	1
10 CPCI backplane	6.5 U, 5 Slot	1	-
CPCI backplane	6.5 U, 7 Slot	-	1
LED display module for MPS monitoring	for 3.3 V, +5 V, ±12 V, fan failure	1	1
11 Fan module	-	1	1
12 DC cable harness	-	•	•
Controller module	with interface for RS-232 and CMC-TC	1	1
Fan module for AC fan	-	•	•

• Included with the supply.

HeiPac 4 U/7 U, 8 slots

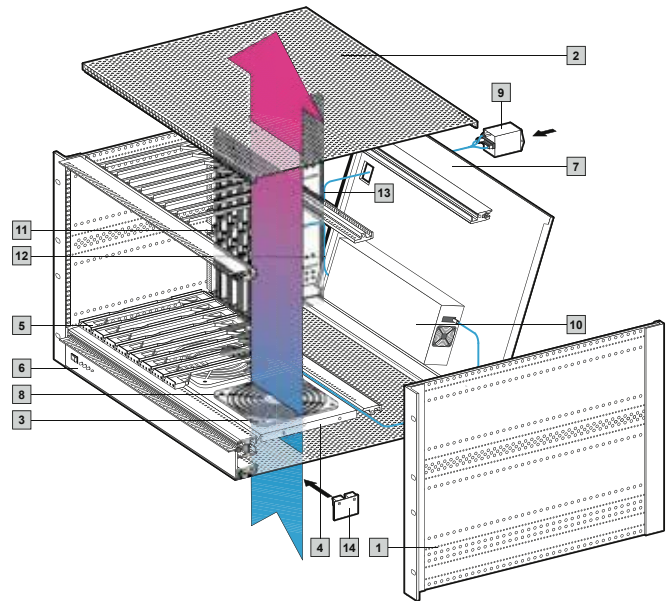

Technical specifications

Subrack, 405 mm deep, for installation in 482.6 mm (19") enclosures or cases. Prepared to accommodate CPCI boards and drives.

Includes MPS Monitoring (see pages 255 ff.)

Complies with IEC 60 297-3-101, -102, -103.

Fully assembled, pre-wired and tested.

Illustration

MPS system 7 U for CPCI

U		4 (3 + 1)	7 (6 + 1)	Page
	Side panel depth mm	405	405	
	Wiring space (depth in mm)	210	210	
	For PCB	3 U x 160 mm	6 U x 160 mm	
	MPS system Model No. for CPCI	9910.946	9910.948	
Mechanical supply includes				
	Description	Material	Qty.	
1	HeiPac basic subrack system (side panels, horizontal rails, flanges, EMC gaskets)	Aluminium, clear-chromated/stainless steel	1	-
2	Top and bottom covers, vented	Aluminium	2	161
3	Finger guard	Polyamide	3	193
4	Fan mounting plate	1 mm aluminium, anodised	1	186
5	Plastic guide rails, keyable	Polycarbonate UL 94-V0	14	155
	Plastic guide rails, keyable, red	Polycarbonate	2	155
6	EMC front panel 1 U/84 HP for MPS monitoring	2.5 mm aluminium, clear-chromated	1	-
	EMC rear panel 4 U/84 HP, horizontally hinged with connector cut-out	2.5 mm aluminium, clear-chromated	1	-
7	EMC rear panel 7 U/84 HP, horizontally hinged with connector cut-out	2.5 mm aluminium, clear-chromated	-	1
Electrical/electronic supply includes				
	Description	Technical specifications		
8	DC fan	24 V DC, 140 m ³ /h, per fan (VDE, UL, CSA) optionally speed-controlled	3	3
9	IEC filtered mains inlet	6 A (VDE, UL, CSA)	1	1
10	Open frame power supply	400 W	-	1
	Power supply unit ATX PS/2	300 W	1	-
	CPCI backplane	3.5 U, 8 Slot	1	-
11	CPCI backplane	6.5 U, 8 Slot	-	1
	LED display module for MPS monitoring	for 3.3 V, +5 V, ±12 V, fan failure	1	1
12	DC cable harness	-	•	-
13	AC cable harness	-	-	•
14	Fan module for DC fan	-	1	1
	Controller module	with interface for RS-232 and CMC-TC	1	1

• Included with the supply.

SYSTEM PLATFORMS

RACK-MOUNT SYSTEMS FOR CompactPCI

HeiPac 7 U, 8 slots

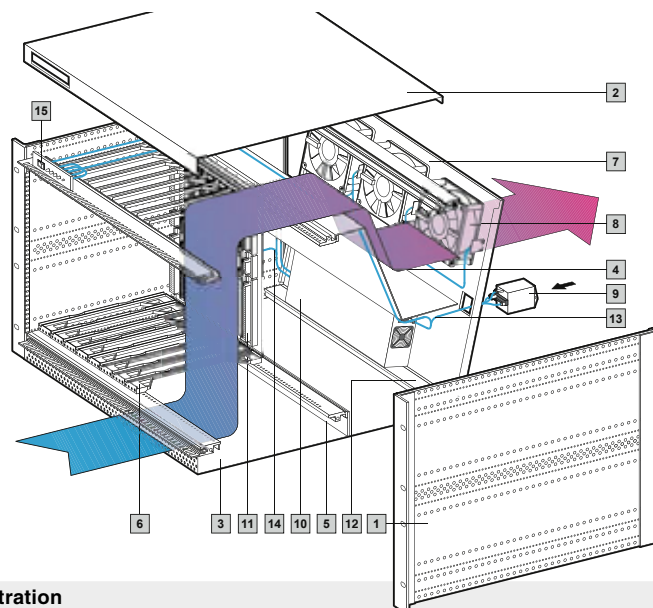

Technical specifications

Subrack, 405 mm deep, for installation in 482.6 mm (19") enclosures or cases. Prepared to accommodate CPCI boards and drives.

Includes MPS Monitoring (see pages 255 ff.)

Complies with IEC 60 297-3-101, -102, -103.

Fully assembled, pre-wired and tested.

Illustration

MPS system 7 U for CPCI

U	7 (6 + 2 x ½)	Page
Side panel depth mm	405	
Wiring space (depth in mm)	210	
For PCB	6 U x 160 mm	
MPS system Model No.	9910.947	

Mechanical supply includes

Description	Material	Qty.	
1 HeiPac basic subrack system (side panels, horizontal rails, flanges, EMC gaskets)	Aluminium, clear-chromated/stainless steel	1	-
2 Cover with ½ U edge fold and cut-outs for LED/switches	Aluminium	1	163
3 Bottom cover with ½ U edge fold, ventilated at the front	Aluminium	1	163
EMC shielding plate for fan	Aluminium, clear-chromated	3	193
4 Air baffle	Aluminium	1	187
5 Air block panel ½ U	Epoxy	1	187
6 Plastic guide rails, keyable	Polycarbonate UL 94-V0	14	155
Plastic guide rails, keyable, red	Polycarbonate	2	155
7 EMC rear panel 7 U, horizontally hinged with connector cut-out	2.5 mm aluminium, clear-chromated	1	-

Electrical/electronic supply includes

Description	Technical specifications		
8 DC fan	12 V DC, 140 m³/h, per fan (VDE, UL, CSA) optionally speed-controlled	3	191
9 IEC filtered mains inlet	6 A (VDE, UL, CSA)	1	257
10 Open frame power supply	400 W	1	-
11 CPCI backplane	3.5 U, 8 Slot	1	238
12 Fan module for DC fan	-	1	-
13 AC cable harness	-	•	-
14 DC cable harness	-	•	-
15 LED display module for MPS monitoring	for 3.3 V, +5 V, ±12 V, fan failure	1	-
Controller module	with interface for RS-232 and CMC-TC	1	-

• Included with the supply.

HeiPac 9 U, 8 slots, with HeiCool radial fan

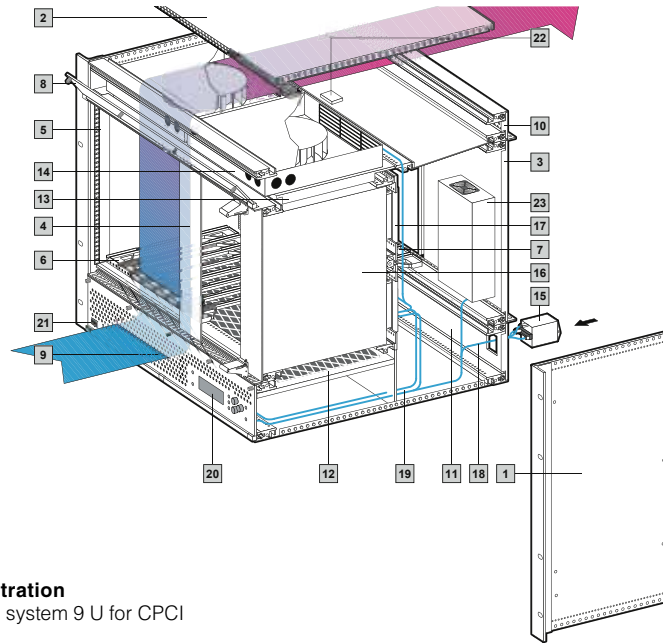

Technical specifications

Subrack, 290.5 mm deep, for installation in 482.6 mm (19") enclosures or cases. Prepared to accommodate CPCI boards and drives.

Includes MPS monitoring (see pages 255 ff.)

Complies with IEC 60 297-3-101, -102, -103.

Fully assembled, pre-wired and tested.

Illustration

MPS system 9 U for CPCI

U		9 (6 + 2 x 1½)	Page
Side panel depth mm		290.5	
Wiring space (depth in mm)		85.5	
For PCB		6 U x 160 mm	
MPS system Model No.		9909.483	
Mechanical supply includes			
Description	Material	Qty.	
1 HeiPac basic subrack system (side panels, horizontal rails, flanges, EMC gaskets)	Aluminium, clear-chromated/stainless steel	1	-
2 Top and bottom covers	Aluminium	2	162
3 EMC rear panel 6 U/28 HP + 8 HP	2.5 mm aluminium, clear-chromated	1	-
4 EMC front panel	2.5 mm aluminium, clear-chromated	1	179
5 EMC contact strip	Aluminium, clear-chromated	1	146
6 Plastic guide rails, keyable	Polycarbonate UL 94-V0	14	155
Plastic guide rails, keyable, red	Polycarbonate	2	155
7 Guide rails for I/O transition modules	Polycarbonate UL 94-V0	16	156
Guide rails, keyable, green, for power supply	Polycarbonate	2	155
8 Front panel 1½ U/84 HP, horizontally hinged	2.5 mm aluminium, clear-chromated	1	-
9 Front panel 1½ U/84 HP, vented, horizontally hinged, for MPS monitoring	2.5 mm aluminium, clear-chromated	1	-
10 EMC rear panel 1½ U/84 HP, vented	2.5 mm aluminium, clear-chromated	1	-
11 EMC rear panel 1½ U/84 HP with connector cut-out	2.5 mm aluminium, clear-chromated	-	-
12 Filter mat 84 HP, 160 mm, for slide-in attachment	-	1	-
13 Mounting plate for HeiCool	1 mm sheet steel, zinc-plated, passivated	1	-
Electrical/electronic supply includes			
Description	Technical specifications		
14 HeiCool DC fan, individually removable including fault alarm signal, speed control	24 V DC, 204 m3/h, 48 W	2	-
15 IEC filtered mains inlet	6 A (VDE, UL, CSA)	1	191
16 Power supply, plug-in, 6 U/8 HP	350 W	1	257
CPCI backplane	6,5 U, 8 Slot	1	238
17 CPCI backplane for power supply	-	1	-
18 AC cable harness	-	•	-
19 DC cable harness	-	•	-
20 Display module	for 3.3 V, +5 V, ±12 V, fan failure	1	-
21 Mains switch	-	1	-
22 Monitoring module for HeiCool	-	1	-
23 Power supply for HeiCool	-	1	-
Controller module	with interface for RS-232 and CMC-TC	1	-

• Included with the supply.

Backplanes, technical specifications

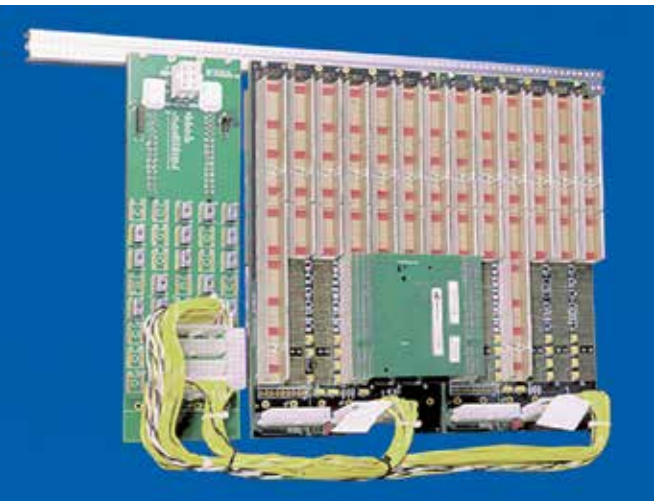

HEITEC offers an extensive range of powerful backplanes for CompactPCI.

- Modular construction facilitates expansion up to a maximum of 21 slots
- Connection between segments via CPCI or H.110 bridge modules
- Power input via ATX-compatible connectors or screw terminal
- Additional 2 x 3 Mate-N-Lock connector for 48 V with H.110 backplane
- Optional development of customer-specific Monolithic backplanes
- 8 layer multi-layer
- System slot on right (left upon request), spray-finished

Modular assembly

The backplanes in 32 or 64-bit versions allow the configuration of CPCI systems from 2 to 21 slots. This is possible due to the modular design of the backplanes and connection of the individual segments via CPCI or H.110 bridge modules. Each backplane segment contains between 2 and 8 slots and operates in stand-alone mode in conjunction with a CPU board and a power supply unit.

For assembling larger systems, several segments may be joined together via PCI bridge modules fitted at the rear. In such cases, only one of the segments will run in the system slot with a CPU board. The remaining segments will have a subordinate status without CPU boards. However, the first slot on the right of the backplane is available for a standard 32 or 64 bit CompactPCI host CPU.

Technical specifications

CPU slot

A single 3 U or 6 U CPU board with 32 or 64 bits is required for each system. The system slot on the right-hand side ensures that 2-slot or wider system boards do not conceal other slots, thus rendering them unusable.

Available slots

Each backplane contains two to eight 3 U or 6 U slots (32 or 64 bit).

Data transfer rate

132/264 MBytes for 32/64 bit version
 +5 V, 33 MHz PCI bus interface
 264/512 MBytes for 32/64 bit version
 +3.3 V, 66 MHz (max. 5 slots) PCI bus interface

PCI bridges

Single backplanes do not require bridges. For each additional backplane, however, a bridge fitted at the rear is required.

Power supply

Voltage supply via one or more ATX connectors

Control connector

Each backplane has a control connector where +3.3, +5, ±12 V voltages may be picked off, e.g. for the connection of power LEDs

I/O-Module für J3 – J5

I/O modules can be connected at the rear of each slot.

Standards

- PCI 2.1 (PCI specification)
- PICMG 2.0 (CompactPCI spec.)
- PICMG 2.1 (hot swap spec.)
- IEEE 1101.1, mechanics
- IEEE 1101.10, mechanics
- IEEE 1101.11, mechanics

CompactPCI – BACKPLANES, TECHNICAL SPECIFICATIONS

32-bit pin assignment

P2 connector⁹⁾

PIN	Z ⁶⁾	A	B	C	D	E	F
22	GND	GA4 ⁵⁾	GA3 ⁵⁾	GA2 ⁵⁾	GA1 ⁵⁾	GA0 ⁵⁾	GND
21	GND	BP(I/O)	BP(I/O)	BP(I/O)	BP(I/O)	BP(I/O)	GND
20	GND	BP(I/O)	BP(I/O)	BP(I/O)	BP(I/O)	BP(I/O)	GND
19	GND	BP(I/O)	BP(I/O)	BP(I/O)	BP(I/O)	BP(I/O)	GND
18	GND	BP(I/O)	BP(I/O)	BP(I/O)	BP(I/O)	BP(I/O)	GND
17	GND	BP(I/O)	BP(I/O)	BP(I/O)	BP(I/O)	BP(I/O)	GND
16	GND	BP(I/O)	BP(I/O)	BP(I/O)	BP(I/O)	BP(I/O)	GND
15	GND	BP(I/O)	BP(I/O)	BP(I/O)	BP(I/O)	BP(I/O)	GND
14	GND	BP(I/O)	BP(I/O)	BP(I/O)	BP(I/O)	BP(I/O)	GND
13	GND	BP(I/O)	BP(I/O)	BP(I/O)	BP(I/O)	BP(I/O)	GND
12	GND	BP(I/O)	BP(I/O)	BP(I/O)	BP(I/O)	BP(I/O)	GND
11	GND	BP(I/O)	BP(I/O)	BP(I/O)	BP(I/O)	BP(I/O)	GND
10	GND	BP(I/O)	BP(I/O)	BP(I/O)	BP(I/O)	BP(I/O)	GND
9	GND	BP(I/O)	BP(I/O)	BP(I/O)	BP(I/O)	BP(I/O)	GND
8	GND	BP(I/O)	BP(I/O)	BP(I/O)	BP(I/O)	BP(I/O)	GND
7	GND	BP(I/O)	BP(I/O)	BP(I/O)	BP(I/O)	BP(I/O)	GND
6	GND	BP(I/O)	BP(I/O)	BP(I/O)	BP(I/O)	BP(I/O)	GND
5	GND	BP(I/O)	BP(I/O)	BP(I/O)	BP(I/O)	BP(I/O)	GND
4	GND	BP(I/O)	BP(I/O)	BP(I/O)	BP(I/O)	BP(I/O)	GND
3	GND	BP(I/O)	BP(I/O)	BP(I/O)	BP(I/O)	BP(I/O)	GND
2	GND	BP(I/O)	BP(I/O)	BP(I/O)	BP(I/O)	BP(I/O)	GND
1	GND	BP(I/O)	BP(I/O)	BP(I/O)	BP(I/O)	BP(I/O)	GND

P1 connector⁹⁾

PIN	Z ⁶⁾	A	B	C	D	E	F
25	GND	5 V	REQ64#	ENUM#	3.3 V	5 V	GND
24	GND	AD (1)	5 V	V(I/O) ³⁾	AD(O)	ACK64#	GND
23	GND	3.3 V	AD (4)	AD (3)	5 V	AD (2)	GND
22	GND	AD (7)	GND	3.3 V	AD (6)	AD (5)	GND
21	GND	3.3 V	AD (9)	AD (8)	M66EN ³⁾	C/BE(0)#	GND
20	GND	AD (12)	GND	V(I/O) ³⁾	AD (11)	AD (10)	GND
19	GND	3.3 V	AD (15)	AD (14)	GND	AD (13)	GND
18	GND	SERR#	GND	3.3 V	PAR	C/BE(1)#	GND
17	GND	3.3 V	SDONE	SBQ#	GND	PERR#	GND
16	GND	DEVSEL	GND	V(I/O) ¹⁾³⁾	STOP#	LOCK#	GND
15	GND	3.3 V	FRAME#	IRDY#	GND ²⁾	TRDY#	GND
12 - 14			KEY AREA				GND
11	GND	AD (18)	AD (17)	AD (16)	GND	C/BE(2)#	GND
10	GND	AD (21)	GND	3.3 V	AD (20)	AD (19)	GND
9	GND	C/BE(3)#	IDSEL	AD (23)	GND	AD (22)	GND
8	GND	AD (26)	GND	V(I/O) ³⁾	AD (25)	AD (24)	GND
7	GND	AD (30)	AD (29)	AD (28)	GND	AD (27)	GND
6	GND	REQ#	GND	3.3 V	CLK	AD (31)	GND
5	GND	BRSVP1A5	BRSVP1B5	RST#	GND	GNT#	GND
4	GND	BRSVP1A4	GND	V(I/O) ³⁾	INTP	INTS	GND
3	GND	INTA#	INTB#	INTC#	5 V	INTD#	GND
2	GND	TCK	5 V	TMS	TDO	TDI	GND
1	GND	5 V	- 12 V	TRST#	+ 12 V	5 V	GND

32-bit and 64-bit backplane – Technical specifications:

The CPCI specifications define both 32-bit and 64-bit versions. Both versions may be implemented on a 3 U daughterboard. However, the 32-bit version allows the complete P2/J2 connector to be used for user-defined I/O signals (slots 2 – 8). Slot 1 (system slot) uses separate P2/J2 pins for functions such as clock, arbitration, (grant/requests) and other system functions. These pins are printed in bold in the table. In 32-bit systems the P2/J2 connection may optionally be populated at the rear with 16 mm long pins and a transfer frame. Signals can be picked off or I/O boards connected at the rear.

64-bit CompactPCI pin assignments – Technical specifications:

With the 64-bit CompactPCI, both P1 and P2 connectors are fully assigned with signals. User-defined I/O signal pins are not available. I/O signals are only available with 6 U boards on connectors P3, P4 and P5.

64-bit pin assignment

P2 connector⁹⁾

PIN	Z ⁷⁾	A	B	C	D	E	F
22	GND	GA4 ⁶⁾	GA3 ⁶⁾	GA2 ⁶⁾	GA1 ⁶⁾	GA0 ⁶⁾	GND
21	GND	CLK6	GND	RSV	RSV	RSV	GND
20	GND	CLK5	GND	RSV	GND ⁵⁾	RSV	GND
19	GND	GND	GND ⁵⁾	RSV	RSV	RSV	GND
18	GND	BRSVP2A18	BRSVP2B18	BRSVP2C18	GND ⁵⁾	BRSVP2E18	GND
17	GND	BRSVP2A17	GND ⁵⁾	PRST#	REQ6#	GNT6#	GND
16	GND	BRSVP2A16	BRSVP2B16	DEG#	GND	BRSVP2E16	GND
15	GND	BRSVP2A15	GND	FAL#	REQ5#	GNT5#	GND
14	GND	AD (35)	AD (34)	AD (33)	GND	AD (32)	GND
13	GND	AD (38)	GND	V(I/O) ³⁾	AD (37)	AD (36)	GND
12	GND	AD (42)	AD (41)	AD (40)	GND	AD (39)	GND
11	GND	AD (45)	GND	V(I/O) ³⁾	AD (44)	AD (43)	GND
10	GND	AD (49)	AD (48)	AD (47)	GND	AD (46)	GND
9	GND	AD (52)	GND	V(I/O) ³⁾	AD (51)	AD (50)	GND
8	GND	AD (56)	AD (55)	AD (54)	GND	AD (53)	GND
7	GND	AD (59)	GND	V(I/O) ³⁾	AD (58)	AD (57)	GND
6	GND	AD (63)	AD (62)	AD (61)	GND	AD (60)	GND
5	GND	C/BE(5)#	GND	V(I/O) ³⁾	C/BE(4)#	PAR64	GND
4	GND	V(I/O) ³⁾	BRSVP2B4	C/BE(7)#	-	C/BE(6)#	GND
3 ³⁾	GND	CLK4	GND	GNT3#	-	GNT4#	GND
2 ³⁾	GND	CLK2	CLK3	SYSEN#⁴⁾	-	REQ3#	GND
1 ³⁾	GND	CLK1	GND	REQ1#	-	REQ2#	GND

P1 connector⁹⁾

PIN	Z ⁷⁾	A	B	C	D	E	F
25	GND	5 V	REQ64#	ENUM#	3.3 V	5 V	GND
24	GND	AD (1)	5 V	V(I/O) ³⁾	AD(O)	ACK64#	GND
23	GND	3.3 V	AD (4)	AD (3)	5 V	AD (2)	GND
22	GND	AD (7)	GND	3.3 V	AD (6)	AD (5)	GND
21	GND	3.3 V	AD (9)	AD (8)	M66EN ⁴⁾⁵⁾	C/BE(0)#	GND
20	GND	AD (12)	GND	V(I/O) ³⁾	AD (11)	AD (10)	GND
19	GND	3.3 V	AD (15)	AD (14)	GND	AD (13)	GND
18	GND	SERR#	GND	3.3 V	PAR	C/BE(1)#	GND
17	GND	3.3 V	SDONE	SBQ#	GND	PERR#	GND
16	GND	DEVSEL#	GND	V(I/O) ¹⁾³⁾	STOP#	LOCK#	GND
15	GND	3.3 V	FRAME#	IRDY#	GND ²⁾³⁾	TRDY#	GND
12 - 14			KEY AREA				GND
11	GND	AD (18)	AD (17)	AD (16)	GND	C/BE(2)#	GND
10	GND	AD (21)	GND	3.3 V	AD (20)	AD (19)	GND
9	GND	C/BE(3)#	IDSEL	AD (23)	GND	AD (22)	GND
8	GND	AD (26)	GND	V(I/O)	AD (25)	AD (24)	GND
7	GND	AD (30)	AD (29)	AD (28)	GND	AD (27)	GND
6	GND	REQ#	GND	3.3 V	CLK	AD (31)	GND
5	GND	BRSVA5	BRSVB 5	RST#	GND	GNT#	GND
4	GND	BRSVA4	GND	V(I/O)	INTP	INTS	GND
3	GND	INTA#	INTB#	INTC#	5 V	INTD#	GND
2	GND	TCK	5 V	TMS	TDO	TDI	GND
1	GND	5 V	- 12 V	TRST#	+ 12 V	5 V	GND

The signals printed in bold are only assigned in the system s lot

1) "Early mate" pin 2) "Late mate" pin 3) +3.3 V or 5 V 4) Earthed with system slot 5) GND for 33 MHz backplane, bussed in 66 MHz systems

6) Each slot may have its own address code (see CPCI specifications) 7) Not for daughtercards 8) Not for CPCI cards after version 1.0

9) All HEITEC standard CPCI backplanes are designed for 64-bit applications on the layout side. With 32-bit versions, the P2/J2 connectors are populated on request.

SYSTEM PLATFORMS

CompactPCI – BACKPLANES

Backplanes 3 U



Material

Fibreglass epoxy to IEC 60 249 (type FR4)

Supply includes

Backplane, fully populated

Backplanes 3 U for low profile bridge

Slot	Design	Model No.	
		32 Bit	64 Bit
2	S	3689.300	3689.307
3	SE	3689.301	3689.308
4	SBME	3689.302	3689.309
5	SBME	3689.303	3689.310
6	SBME	3689.304	3689.311
7	SBE	3689.305	3689.312
8	S	3689.306	3689.313

S = Stand alone
 B = Beginning segment
 M = Middle segment
 E = Ending segment

Number of layers	8, 10 (for 3 U)
Layer structure	2 GND Layer
PCB thickness	3.2 mm
Data transfer rate	132/264 MBytes/32, 64 Bit
Power inlets	3 U: Via screws and busbars
Control connector	+3,3 V, +5 V, +12 V, -12 V
VI/O (3 U)	Adjustable to +5 V or +3.3 V
CPU slot	on right (left upon request)
Standards	PCI 2.1 (PCI Spec.) PICMG 2.0 (CompactPCI) PICMG 2.1 (hot swap) IEEE 1101.1/10/11
Installation height	3 U
Distance between slots	4 HP
Connectors	J1, J2 32 or 64 bit No rear I/O
Operating temperature range	0° - 70°C
Relative humidity	90 %, non-condensing
Geographic addressing	64-bit versions

Backplanes 6 U



Material

Fibreglass epoxy to IEC 60 249 (type FR4)

Supply includes

Backplane, fully populated

Backplanes 6 U for low profile bridge

Slot	Design	Model No.	
		32 Bit	64 Bit
2	S	3689.314	3689.321
3	SE	3689.315	3689.322
4	SBME	3689.316	3689.323
5	SBME	3689.317	3689.324
6	SBME	3689.318	3689.325
7	SBE	3689.319	3689.326
8	S	3689.320	3689.327

S = Stand alone

B = Beginning segment

M = Middle segment

E = Ending segment

Number of layers	8, 10 (for 6 U)
Layer structure	2 GND Layer
PCB thickness	3.2 mm
Data transfer rate	132/264 MBytes/32, 64 Bit
Power inlets	6 U: Via screws and busbars
Control connector	+3,3 V, +5 V, +12 V, -12 V
VI/O (6 U)	Adjustable to +5 V or +3.3 V
CPU slot	on right (left upon request)
Standards	PCI 2.1 (PCI Spec.) PICMG 2.0 (CompactPCI) PICMG 2.1 (hot swap) IEEE 1101.1/10/11
Installation height	6 U
Distance between slots	4 HP
Connectors	J1, J2 32 or 64 bit J3, J4, J5 for rear I/O (64 bit only)
Operating temperature range	0° - 70°C
Relative humidity	90 %, non-condensing
Geographic addressing	64-bit versions

SYSTEM PLATFORMS

CompactPCI – BACKPLANES

Power supply board 3 U/3.5 U



- Board 3U/3,5 U, 8 HP, 16 HP, 24 HP
- For use in conjunction with HEITEC CPCI back planes
- Accomodation of 1/2/3 power supplies up to 250 W each
- AC/DC connection is made via two 2 x 3-pole connectors
- Outgoing voltages to supply one or more CPCI backplanes are available at ATX-compatible connectors
- Complies with PICMG 2.0, PICMG 2.11

Technical specifications

Accommodation of 1/2/3 CPCI power supplies of up to 250 W.

The second power supply unit may be used for redundancy (with power distribution) or, via parallel connection, to increase the current.

Input voltages:

- AC input via 2 x 3-pole AMP Mate-N-Lock (AMP # 350732-1), connector J12
- Connected via pin 45, 46, 47, type Positronic
- Maximum current load per pin is 25 A, matching counter-connector for cable harness AMP # 350715
- DC input via 2 x 3-pole AMP Mate-N-Lock (AMP # 350732-1), connector J5 connected via pin 46, 47, type Positronic
- Maximum current load per pin is 25 A, matching counter-connector for cable harness AMP # 350715
- Output voltage:
- Three 20-pole ATX-compatible connectors for ATX cable harness (connection of power supply board to CPCI backplane)

Material

Fibreglass epoxy to IEC 60 249 (FR4)

Supply includes

Board, fully populated

Description	HP	Model No.
3 U for 1 x plug-in power supply with Positronic connector, 47-pin	8	9905.105
3 U Board for 3 x plug-in power supply with Positronic connector, 47-pin	24	9904.131
3,5 U Board for 2 x plug-in power supply with Positronic connector, 47-pin	16	3688.603
ATX (12 ") cable harness		9810.337
ATX (16 ") cable harness		3686.570
ATX (19 ") cable harness		9810.338

HE = U
TE = HP

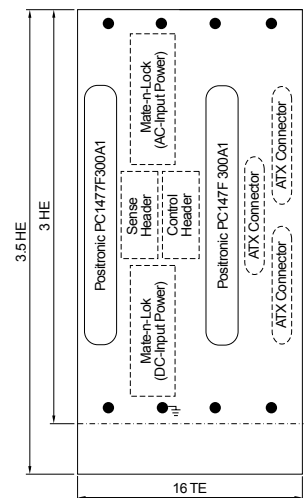

Power supply board 6 U/6.5 U, 8 HP

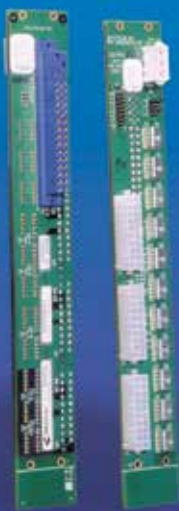

- Board 6 U/6.5 U, (0.5 U removable) 8 HP
- For use in conjunction with HEITEC CPCI backplanes 3.5 U, 6.5 U, H.110
- Accommodation of a power supply with up to 500 W
- AC/DC connection is made via 3-pole connectors
- Outgoing voltages to supply one or more CPCI backplanes are available at 3 ATX-compatible connectors or at special power terminals
- Complies with PICMG 2.0, PICMG 2.11

Technical specifications

Accommodation of a 6 U CPCI power supply of up to 500 W.

Input voltages:

- AC input via 3-pole AMP Mate-N-Lock connector max. current capacity per pin 25 A
- DC input via 3-pole AMP Mate-N-Lock connector Max. current capacity per pin 25 A Output voltage:
- Three 20-pole ATX-compatible connectors for ATX cable harness (connection of power supply board to CPCI backplane) and/or special power terminals

Material

Fibreglass epoxy to IEC 60 249 (FR4)

Supply includes

Board, fully populated

Note

Plug-type power supplies, see page 198

Description	Model No.
Board for 1 x plug-in power supply with Positronic connector, 47-pin	3688.607
ATX (12 ") cable harness	9810.337
ATX (16 ") cable harness	3686.570
ATX (20 ") cable harness	9810.338

HE = U

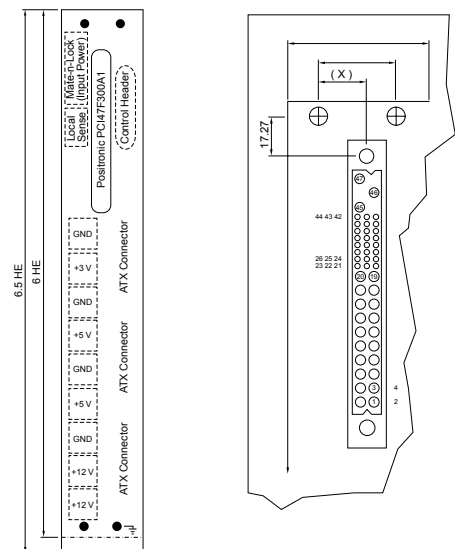

Power supply board 6 U/6.5 U, 16 HP

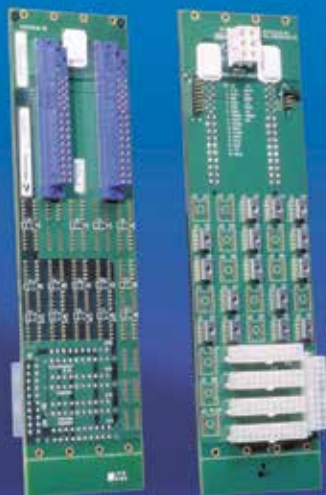

- Board 6 U/6.5 U, (0.5 U removable) 16 HP
- For use in conjunction with HEITEC CPCI backplanes 3.5 U and 6.5 U
- Accommodation of two power supplies with up to 500 W
- AC/DC connection is made via two 2 x 3-pole connectors
- Outgoing voltages to supply one or more CPCI backplanes are available at 5 ATX-compatible connectors or at special power terminals
- Complies with PICMG 2.0, PICMG 2.11

Technical specifications

Accommodation of 2 x 6 U CPCI power supplies of up to 500 W

Input voltages:

- AC input via 2 x 3-pole AMP Mate-N-Lock connector Max. current capacity per pin 25 A
 - DC input via 2 x 3-pole AMP Mate-N-Lock connector Max. current capacity per pin 25 A
- Output voltage:
- Five 20-pole ATX-compatible connectors for ATX cable harness (connection of power supply board to CPCI backplane)

Material

Fibreglass epoxy to IEC 60 249 (FR4)

Supply includes

Board, fully populated

Note

Plug-in power supplies, see page 198

Description	Model No.
Board for 2 x plug-in power supplies with Positronic connector, 47-pin	3688.608
ATX (12 ") cable harness	9810.337
ATX (16 ") cable harness	3686.570
ATX (20 ") cable harness	9810.338

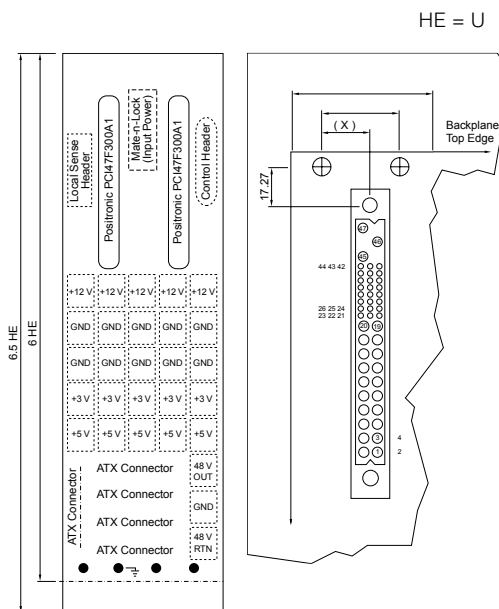

Power supply board 9U Monolithic with power supply connector



Material

Fibreglass epoxy to IEC 60 249 (FR4)

Supply includes

Board, fully populated

- S = Stand alone
- B = Beginning segment
- M = Middle segment
- E = Ending segment

Slot	Positronic connector, 47 Pin	ATX	Model No.
2 ¹⁾	1	0	3689.329
4	2	1	3689.330
6	3	1	3689.331
8	4	1	3689.332

Systemslot on right 64 Bit with Rear I/O, V I/O: +5.0 V. H. 110 not connected with systemslot.

¹⁾without H.110

SYSTEM PLATFORMS OVERVIEW RACK-MOUNT SYSTEMS FOR CompactPCI SERIAL

CPCI-S

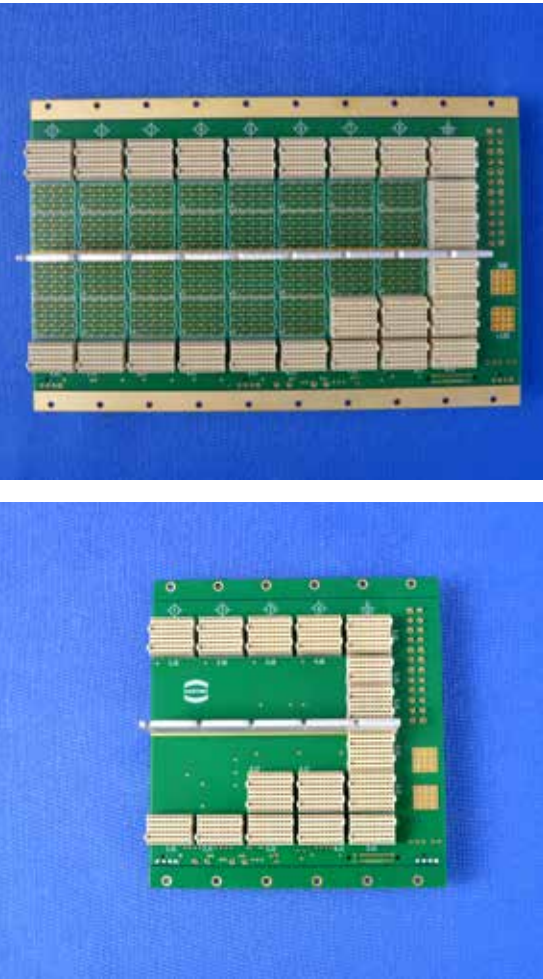

The CompactPCI serial specification is the logical extension of the CompactPCI standard. This new standard replaces the existing CompactPCI parallel signals with rapid serial data links. The central supply voltage has also been raised to 12 V DC. The mechanical specification of the CompactPCI serial standard completely matches that of the CompactPCI standard, with the exception of new backplane plug connectors. This means the dimensions for the plug-in cards, backplanes and even the front panels remain unchanged. The new standard makes it possible to produce backplanes with up to nine slots (one system and eight peripheral slots) and full-mesh Ethernet. Upon request, HEITEC can also offer platforms with hybrid backplanes in accordance with the CompactPCI-Plus IO standard, to help customers make a step-by-step transition. CompactPCI system cards and CompactPCI serial periphery cards can be used in this connection.

Our range of services comprises complete plug & play systems including backplanes, power supply and effective cooling units. The following subracks represent just a small selection of the available portfolio.

CompactPCI® Serial

HeiPac VM-A CPCI-S



NEW

9 SLOT CompactPCI® SERIAL platform for 3 U modules

Technical Summary

- Desktop/system case 310 mm deep
- Side panels of extruded aluminum profile painted in RAL 7035
- 4 U case with 3 U card cage and feet
- Incl. power supply and pluggable fan drawer
- Codable card guides
- 9-slot CompactPCI® serial backplane as per PICMG CPCI-S.0 R2.0
- Ethernet Full Mesh topology
- Alternatively, Ethernet Single Star option
- 2 Fat Pipes PCIeexpress
- CompactPCI® serial system slot on the right
- Alternative system slot possible on the left, rear transition module slots upon request
- Cooling with up to 3 fans in fan drawer – integrated cooling from bottom to top
- ATX 400W Power supply 100-240V
- Corresponds to IEC 60297-3-101, 102, 103 and IEEE 1101.1/10/11
- Completely mounted, prewired and tested
- EMC version
- Individual interior design and variable position of the backplane possible
- Simple handling via side grips

Packs of	Order no.
1	9919.605

Customer Benefits

- Modular components allow flexible adaptation and customization
- System slot on the right enables use of an 8 HP CPU module without giving up one of the CompactPCI® serial slots
- Efficient cooling system via up to three fans in the fan drawer
- Variably deployable as desktop and rack-mount case
- Wide range of accessories
- Chassis with visual appeal – adaptable to suit individual color preferences

OVERVIEW RACK-MOUNT SYSTEMS FOR CompactPCI SERIAL

HeiPac Vario-A CPCI-S



NEW

5 SLOT CompactPCI® SERIAL platform
FOR 3 U modules

Technical Summary

- Subrack 250 mm deep
- 4 U subrack with 3 U card cage
- Clear-chromated aluminum
- Incl. power supply and axial fan – cooling from bottom to top
- Codable card guides
- 5-slot CompactPCI® serial backplane as per PICMG CPCI-S.0 R2.0
- Ethernet in Single Star topology
- Alternatively, Ethernet Full Mesh option
- 2 Fat Pipes PCIeexpress
- CompactPCI® serial system slot on the right
- Alternative system slot possible on the left, RTM upon request
- Scalable: project-related up to 8 slot CompactPCI® serial or hybrid backplane can be integrated
- Optional fanless usage (convection cooling)
- ATX power supply 100-240VAC with 204 W at 12 V
- Scalable: project-specific power supply, solutions with up to 2 plug-in redundant CompactPCI® serial power supplies possible
- Corresponds to IEC 60297-3-101, 102, 103 and IEEE 1101.1/10/11
- Completely mounted, prewired and tested
- EMC version

Packs of	Order no.
1	9919.911

Customer Benefits

- Very cost-effective platform solution
- System slot on the right enables use of an 8 HP CPU module without giving up one of the CompactPCI® serial slots
- Variable number of slots – other backplanes can also be integrated at modest cost depending on the project, even for low unit quantities
- Efficient cooling system – fanless usage also possible depending on application
- Fast and easy assembly
- Modular components allow flexible adaptation and customization

HeiPac Vario VM-R CPCI-S



NEW

5 SLOT CompactPCI® SERIAL platform
for 3 U modules

Technical Summary

- Desktop/system case 250 mm deep
- Side panels of extruded aluminum profile painted in RAL 7035
- 4 U case with 3 U card cage
- Incl. power supply and two radial fans
- Codable card guides
- 5-slot CompactPCI® serial backplane as per PICMG CPCI-S.0 R2.0
- Ethernet in Star topology – alternatively, Ethernet Full Mesh option
- 2 Fat Pipes PCIeexpress
- CompactPCI® serial system slot on the right
- Alternative system slot possible on the left, RTM upon request
- Scalable: project-related up to 8 slot CompactPCI® serial or hybrid backplane can be integrated
- ATX power supply 100-240VAC with 204 W at 12 V
- Scalable: project-specific power supply, solutions with up to 2 plug-in redundant CompactPCI® serial power supplies possible
- Corresponds to IEC 60297-3-101, 102, 103 and IEEE 1101.1/10/11
- Completely mounted, prewired and tested
- EMC version

Packs of	Order no.
1	9919.912

Customer Benefits

- Modular components allow flexible adaptation and customization
- System slot on the right enables use of an 8 HP CPU module without giving up one of the CompactPCI® serial slots
- Variable number of slots – other backplanes can also be integrated at modest cost depending on the project, even for low unit quantities
- Efficient cooling system from the lower front to upper rear using two radial fans
- Modular components allow flexible adaptation and customization
- Wide range of accessories
- Chassis with visual appeal – adaptable to suit individual color preferences

SYSTEM PLATFORMS

OVERVIEW RACK-MOUNT SYSTEMS FOR VMEbus

Slim-box Vario VME64x Systems



2 U, 4 U
Order no. on request

Applications

Configuration of 19" industrial computer systems according to VME specification for

- Process Control
- Traffic Management System
- Image Processing
- Industrial Automation

Technical specifications

- 482.6 mm (19") rack-mount system for horizontal mounting of front boards and rear I/O cards
- 1 U, 2 U, 3 U, 4 U, 300 mm deep
- Standard cooling from left to right side
- Sheet steel, spray-finished (black)
- Preconfigured systems including backplane and fan
- Completely assembled, pre-wired and tested
- Installation of VME64x boards according to VME specification

Benefits at a glance

- Horizontal installation of Eurocards/ double Eurocards
- Maximum installation with minimum space requirement
- 2/4/6/8 slots for 160 mm front and 80 mm rear boards
- Hot swap compatible power supply, AC or DC optionally
- EMC and ESD protection
- Completely assembled, pre-wired and tested
- Integrated cooling from left to right side
- Modular assembly ensures individual configuration
- Conforms to IEC 60 297-3-101,-102,-103

HeiPac VME/VME64x Systems



3 U, 5 slots/ 4 U, 7 slots horizontal
Order no. see page 246

Applications

Configuration of 19" industrial computer systems according to VME specification for

- Process Control
- Traffic Management System
- Image Processing
- Industrial Automation

Technical specifications

- 482.6 mm (19") rack-mount system for horizontal mounting of double Eurocards
- 3 U, 4 U, 405 mm deep
- Aluminium, clear-chromated
- Including backplane, power supply and rear fan
- Completely assembled, pre-wired and tested
- Horizontal installation space for double Eurocards: 5 and 7 slots
- Installation of VME- or VME64x boards according to VME specification

Benefits at a glance

- Horizontal installation of double Eurocards
- EMC and ESD protection
- Completely assembled, pre-wired and tested
- Well-directed air ducting from front to rear via fans in the rear panel
- Keyable guide rails
- Conforms to IEC 60 297-3-101,-102,-103

HeiPac VME/VME64x Systems



4 U/ 7 U, 12 slots
Order no. see page 247

Applications

Configuration of 19" industrial computer systems according to VME specification for

- Process Control
- Traffic Management System
- Image Processing
- Industrial Automation

Technical specifications

- 482.6 mm (19") rack-mount system for vertical mounting of Eurocards/double Eurocards
- 4 U and 7 U, 405 mm deep
- Aluminium, clear-chromated
- Including backplane and power supply
- Fan unit with 3 DC fans
- Completely assembled, pre-wired and tested
- Installation space for double Eurocards: 12 slots
- Installation of VME- or VME64x boards according to VME specification

Benefits at a glance

- Vertical installation of double Eurocards
- EMC and ESD protection
- Completely assembled, pre-wired and tested
- Fan module ensures well-directed air flow from bottom to top
- Keyable guide rails
- Conforms to IEC 60 297-3-101,-102,-103

HeiPac VME/VME64x Systems



7 U, 12 slots
Order no. see page 248

Applications

Configuration of 19" industrial computer systems according to VME specification for

- Process Control
- Traffic Management System
- Image Processing
- Industrial Automation

Technical specifications

- 482.6 mm (19") rack-mount system for vertical mounting of double Eurocards
- 7 U, 405 mm deep
- Aluminium, clear-chromated
- Including backplane, power supply and rear fan
- Completely assembled, pre-wired and tested
- Installation space for Eurocards/double Eurocards: 12 slots
- Installation of VME- or VME64x boards according to VME specification

Benefits at a glance

- Vertical installation of double Eurocards
- EMC and ESD protection
- Completely assembled, pre-wired and tested
- Well-directed air flow from front to rear
- Keyable guide rails
- Corresponds to IEC 60 297-3-101,-102,-103

HeiPac VME/VME64x Systems



9 U, 12 slots with RiCool and Rear I/O
Order no. see page 249

Applications

Configuration of 19" industrial computer systems according to VME specification for

- Process Control
- Traffic Management System
- Image Processing
- Industrial Automation

Technical specifications

- 482.6 mm (19") rack-mount system for vertical mounting of double Eurocards
- 9 U, 290.5 mm deep, on the rear side for I/O modules
- Aluminium, clear-chromated
- Including backplane, power supply and 2 radial fans HeiCool (204 m3/h)
- Completely assembled, pre-wired and tested
- Installation space for Eurocards/double Eurocards: 12 slots
- Installation of VME- or VME64x boards according to VME specification

Benefits at a glance

- Vertical installation of double Eurocards
- EMC and ESD protection
- Completely assembled, pre-wired and tested
- Well-directed air flow from front to rear
- Rear I/O transition modules
- Keyable guide rails
- Effective ventilation by 2 radial fans HeiCool (204 m3/h)
- Conforms to IEC 60 297-3-101,-102,-103

SYSTEM PLATFORMS

RACK-MOUNT SYSTEMS FOR VME/VME64x

HeiPac 3 U, 5 slots/4 U, 7 slots horizontal

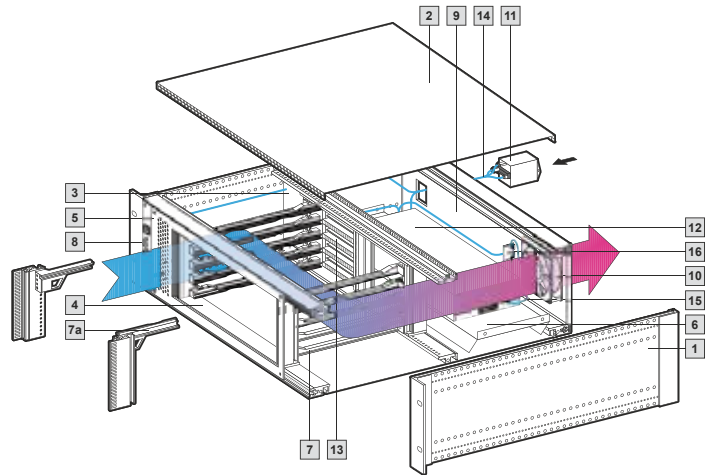

Technical specifications

Subrack, 405 mm deep, for installation in 482.6 mm (19") enclosures or cases. Prepared to accommodate VMEbus boards and drives.

Includes MPS monitoring (see pages 255 ff.)

Complies with IEC 60 297-3-101,-102, -103,

Fully assembled, pre-wired and tested.

Illustration

MPS system 3 U

U	3	3	4	4	Page
Side panel depth mm	405	405	405	405	
Wiring space (depth in mm)	210	210	210	210	
For PCB	6 U x 160 mm	6 U x 160 mm	6 U x 160 mm	6 U x 160 mm	
MPS system Model no. for VME	9910.949	-	9910.954	-	
MPS system Model no. for VMe64x	-	9910.950	-	9910.955	

Mechanical supply includes

Description	Material	Qty.				
1 HeiPac basic subrack system (side panels, horizontal rails, flanges, EMC gaskets)	Aluminium, clear-chromated/stainless steel	1	1	1	1	-
2 Top and bottom covers, solid	Aluminium	2	2	2	2	161
3 Air partition	Aluminium	1	1	1	1	187
4 Horizontal mounting kit	Aluminium, clear-chromated	1	1	1	1	151
5 Trim frame for horizontal mounting kit	2.5 mm aluminium, clear-chromated	1	1	1	1	151
6 Mounting base for power supply unit	2 mm aluminium, anodised	1	1	1	1	201
EMC shielding plate for fan	Aluminium, clear-chromated	1	1	1	1	193
7 Guide rails	Polycarbonate UL 94-V0	10	-	14	-	154
7a Plastic guide rails, keyable	Polycarbonate UL 94-V0	-	10	-	14	155
8 EMC front panel 3 U or 4 U/5 HP, with MPS monitoring	2.5 mm aluminium, clear-chromated	1	1	1	1	-
9 EMC rear panel 3 U/84 HP with fan and connector cut-out	2.5 mm aluminium, clear-chromated	1	1	-	-	-
EMC rear panel 4 U/84 HP with fan and connector cut-out	2.5 mm aluminium, clear-chromated	-	-	1	1	-

Electrical/electronic supply includes

Description	Technical specifications	Qty.				
10 DC fan	12 V DC, 48 m ³ /h per fan (UL, CSA, VDE) optionally speed-controlled	1	1	1	1	191
11 IEC filtered mains inlet	6 A (VDE, UL, CSA)	1	1	1	1	257
12 Switch mode power supply unit	250 W	1	1	1	1	-
13 VME backplane	J1, 5 slots, IN-board, passive, ADC	1	-	-	-	254
VME64x backplane	J1/J2, 5 slots (without P0)	-	1	-	-	252
VME backplane	J1, 7 slots, IN-board, passive, ADC	-	-	1	-	254
VME64x backplane	J1/J2, 7 slots	-	-	-	1	252
LED display module for MPS monitoring	for +5 V, ±12 V, fan failure	1	1	1	1	-
14 AC cable harness	-	•	•	•	•	-
15 DC cable harness	-	•	•	•	•	-
16 Fan module for DC fan	-	1	1	1	1	-
Controller module	with interface for RS-232 and CMC-TC	1	1	1	1	-

HeiPac 4 HE/7 HE, 12 Slot

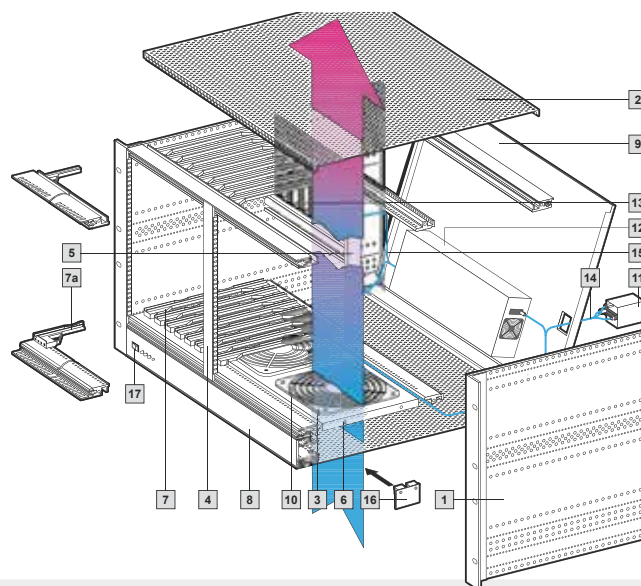

Technical specifications

Subrack, 405 mm deep, for installation in 482.6 mm (19") enclosures or cases. Prepared to accommodate VMEbus boards and drives.

Includes MPS Monitoring (see pages 255 ff.)

Complies with IEC 60 297-3-101, -102, -103,

Fully assembled, pre-wired and tested.

Illustration

MPS system 7 U

U	4 (3 + 1)	7 (6 + 1)	7 (6 + 1)	Page
Side panel depth mm	405	405	405	
Wiring space (depth in mm)	210	210	210	
For PCB	3 U x 160 mm	3 U/6 U x 160 mm		
MPS system Model No. for VME	9909.484	9910.956	-	
MPS system Model No. for VME64x	-	-	9910.957	

Mechanical supply includes

Description	Material	Qty.			
1 HeiPac basic subrack system (side panels, horizontal rails, flanges, EMC gaskets)	Aluminium, clear-chromated/stainless steel	1	1	1	-
2 Top and bottom covers, vented	Aluminium	2	2	2	161
3 Finger guard	Polyamid	3	3	3	192
4 EMC front panel, 6 U/4 HP (with 7 U)	Aluminium, clear-chromated	-	1	-	-
5 Support, vertical (with 7 U)	Aluminium, clear-chromated	-	1	-	150
6 Fan mounting plate	1 mm aluminium, anodised	1	1	1	186
7 Guide rails	Polycarbonate UL 94-V0	24	24	-	154
7a Plastic guide rails, keyable	Polycarbonate UL 94-V0	-	-	24	155
8 EMC front panel 1 U/84 HP for switches/LED	2.5 mm aluminium, clear-chromated	1	1	1	-
Rear panel 4 U/84 HP, horizontally hinged with connector cut-out	2.5 mm aluminium, clear-chromated	1	-	-	-
9 EMC rear panel 7 U/84 HP, horizontally hinged with connector cut-out	2.5 mm aluminium, clear-chromated	-	1	1	-

Electrical/electronic supply includes

Description	Technical specifications	Qty.			
10 DC fan	12 V DC, 140 m ³ /h per fan (VDE, UL, CSA) optionally speed-controlled	3	3	3	191
11 IEC filtered mains inlet	6 A (VDE, UL, CSA)	1	1	1	257
12 Switch mode power supply unit	400 W	1	1	1	196
13 VME backplane	J1, 12 slots, IN-board, passive, ADC	1	1	-	254
VME64x backplane	J1/J2, 12 slots	-	-	1	252
17 LED display module for MPS monitoring	for (3.3 V), +5 V, ±12 V, fan failure	1	1	1	-
14 AC cable harness	-	•	•	•	-
15 DC cable harness	-	•	•	•	-
16 Fan module for DC fan	-	1	1	1	-
Controller module	with interface for RS-232 and CMC-TC	1	1	1	-

SYSTEM PLATFORMS

RACK-MOUNT SYSTEMS FOR VME/VME64x

HeiPac 7 U, 12 slots

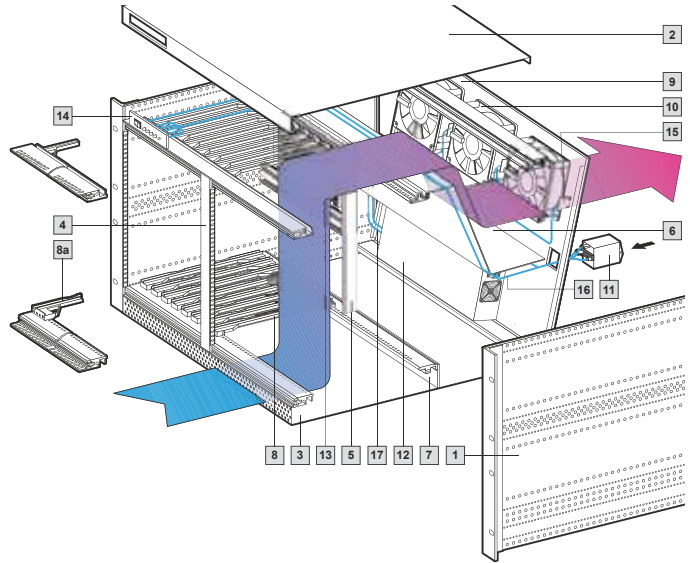

Technical specifications

Subrack, 405 mm deep, for installation in 482.6 mm (19") enclosures or cases. Prepared to accommodate VMEbus boards and drives.

Includes MPS Monitoring (see pages 255 ff.)

Complies with IEC 60 297-3-101,-102, -103,

Fully assembled, pre-wired and tested.

U	7 (6+ 2 x ½)	7 (6+ 2 x ½)	Page
Side panel depth mm	405	405	
Wiring space (depth in mm)	210	210	
For PCB	6 U x 160 mm	6 U x 160 mm	
MPS system Model No. for VME	9910.958	-	
MPS system Model No. for VME64x	-	9910.959	

Mechanical supply includes

Description	Material	Qty.		
1 HeiPac basic subrack system (side panels, horizontal rails, flanges, EMC gaskets)	Aluminium, clear-chromated/ stainless steel	1	1	-
2 Cover with ½ U edge fold and cut-outs for switches/LEDs	Aluminium	1	1	163
3 Bottom cover with ½ U edge fold, ventilated at the front	Aluminium	1	1	163
4 EMC front panel 6 U/4 HP	2.5 mm aluminium, clear-chromated	1	-	-
EMC shielding plate for fan	Aluminium, clear-chromated	3	3	193
5 Vertical support	Aluminium, clear-chromated	1	-	150
6 Air baffle	1 mm aluminium, anodised	1	1	187
7 Air block panel, ½ U	Epoxyd	1	1	187
8 Guide rails	Polycarbonate UL 94-V0	24	-	154
8a Plastic guide rails, keyable	Polycarbonate UL 94-V0	-	24	155
9 EMC rear panel, horizontally hinged, 7 U, with fan and connector cut-out	2.5 mm aluminium, clear-chromated	1	1	-

Electrical/electronic supply includes

Description	Technical specifications	Qty.		
10 DC fan	12 V DC, 140 m³/h per fan, (UL, CSA, VDE) optional speed control	3	3	191
11 IEC filtered mains inlet	6 A (VDE, UL, CSA)	1	1	257
12 Switch mode power supply unit	400 W	1	1	196
13 VME backplane	J1, 12 slots, IN-board passive, ADC	1	-	254
VME64x backplane	J1/J2, 12 slots (without P0)	-	1	252
14 LED display module for MPS monitoring	for (3.3 V), +5 V, ±12 V, fan failure	1	1	-
15 Fan module for DC fan	-	1	1	-
16 AC cable harness	-	•	•	-
17 DC cable harness	-	•	•	-
Controller module	with interface for RS-232 and CMC-TC	1	1	-

HeiPac 9 U, 12 slots, with HeiCool radial fan

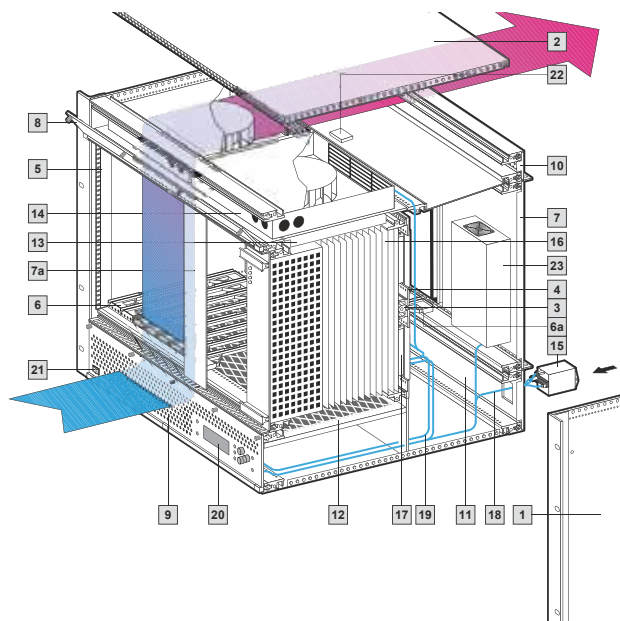

Technical specifications

Subrack, 290.5 mm deep, for installation in 482.6 mm (19") enclosures or cases. Prepared to accommodate VMEbus boards and drives.

Includes MPS Monitoring (see pages 255 ff.)

Complies with IEC 60 297-3-101, -102, -103,

Fully assembled, pre-wired and tested.

U	9 (6 + 2 x 1½)	Page
Side panel depth mm	290.5	
Wiring space (depth in mm)	85.5	
For PCB	6 U x 160 mm	
MPS system Model No. for VME64x	9910.960	

Mechanical supply includes

Description	Material	Qty.	
1 HeiPac basic subrack system (side panels, horizontal rails, flanges, EMC gaskets)	Aluminium, clear-chromated/stainless steel	1	-
2 Top and bottom covers, solid	1 mm Aluminium	2	161
3 Centre horizontal rail 12 HP	1 mm aluminium, clear-chromated	1	-
4 Z rail 12 HP	Aluminium, clear-chromated	4	-
5 EMC contact strip	Aluminium, clear-chromated	2	146
6 Plastic guide rails, keyable	Polycarbonate UL 94-V0	24	155
Guide rails, keyable, green, for power supply	Polycarbonate UL 94-V0	2	155
6a Guide rails for I/O transition modules	Polycarbonate UL 94-V0	24	-
7 EMC rear panel 6 U/36 HP	2.5 mm aluminium, clear-chromated	1	-
7a EMC front panel	2.5 mm aluminium, clear-chromated	1	-
8 Front panel 1½ U/84 HP, horizontally hinged	2.5 mm aluminium, clear-chromated	1	-
9 Front panel 1½ U/84 HP, vented, horizontally hinged, for MPS monitoring	2.5 mm aluminium, clear-chromated	1	-
10 EMC rear panel 1½ U/84 HP, vented	2.5 mm aluminium, clear-chromated	1	-
11 EMC rear panel, 11/2 U/84 HP, with connector cut-out	2.5 mm aluminium, clear-chromated	1	-
12 Filter mat 160 mm, 84 HP, for slide-in attachment	-	1	-
13 Mounting plate for HeiCool	1 mm sheet steel, zinc-plated, passivated	1	-

Electrical/electronic supply includes

Description	Technical specifications	Qty.	
14 HeiCool DC fan, individually removable. Including fault alarm signal, speed control	24 V DC, 204 m³/h, 48 W	2	-
15 IEC filtered mains inlet	6 A (VDE, UL, CSA)	1	257
16 Power supply, plug-in, 6 U/12 HP	270 W	1	197
Backplane VME64x, without P0	J1/J2, 12 slots	1	252
17 Female connector for power supply unit	H15	2	-
18 AC cable harness	-	•	-
19 DC cable harness	-	•	-
20 Display module	for +5 V, ±12 V, fan failure	1	-
21 Mains switch	-	1	-
22 Monitoring module for HeiCool and backplane	-	2	-
23 Power supply for HeiCool	-	1	-
Controller module	-	1	-
Temperature module	-	1	-

SYSTEM PLATFORMS

VMEbus – BACKPLANES

Technical specifications

General technical specifications VMEbus

The VMEbus, based on standard IEEE 1014 and IEC 821, has become established worldwide as an industry standard. The VME64 is a new addition to the VME family to ANSI/VITA 1-1994 and supports 64-bit data traffic. The VME64x extends the VME family to ANSI/VITA 1.1-1997 and is available with the optional 133-pole 2 mm connector J0. 160-pole connectors are used with VME64x. This system remains backward compatible, so that assemblies with 96-pole connectors to IEC 60 603-2 may still be used. All HEITEC VMEbus boards are of a HIGH SPEED DESIGN. Minimal reflections are achieved, due to even surge impedance of the signal track. The consistent shielding of every signal track ensures minimum coupling and hence guarantees interference-free operation even when extended to 64 bit mode with the 2e protocol (160 Mbit/s).

Daisy-chain circuit

With the daisy-chain circuit, a distinction is made between manual daisy-chaining and automatic daisy-chaining. Automatic daisy-chaining renders the connection of jumpers superfluous, and users are saved the time-consuming task of insertion and extraction. What is more, possible misconnections are avoided. Automatic daisy-chaining can be achieved in two ways. HEITEC VME backplanes are generally supplied with automatic daisy-chaining.

Termination

In order to avoid malfunctions on signal tracks that may arise as a result of reflections on the exposed track end, these must be terminated with the VMEbus. Termination may be either ON-/IN-board (on the backplane) or OFF-board (external). With regard to the type of termination, a distinction is made between passive and active termination. The benefit of active termination lies in the lower closed-circuit current consumption. Passive termination is distinguished by superior frequency response and a broader temperature range.

Pin assignment J1 and J2

Pin assignment for J1 connector VME64x					
Pin no.	Pin assignment for J1 connector VME				
	Z	A	B	C	D
1	MPR	D00	BBSY	D08	VPC
2	GND	D01	BCLR	D09	GND
3	MCLK	D02	ACFAIL	D10	+ V1
4	GND	D03	BG0IN	D11	+ V2
5	MSD	D04	BG0OUT	D12	RsvU
6	GND	D05	BG1IN	D13	- V1
7	MMD	D06	BG1OUT	D14	- V2
8	GND	D07	BG2IN	D15	RsvU
9	MCTL	GND	BG2OUT	GND	GAP
10	GND	SYSCLK	BG3IN	SYSFAIL	GAO
11	RTRY1	GND	BG3OUT	BERR	GA1
12	GND	DS1	BR0	SYSRESET	+3.3 V
13	RsvBus	DS0	BR1	LWORD	GA2
14	GND	WRITE	BR2	AM5	+3.3 V
15	RsvBus	GND	BR3	A23	GA3
16	GND	DTACK	AM0	A22	+3.3 V
17	RsvBus	GND	AM1	A21	GA4
18	GND	AS	AM2	A20	+3.3 V
19	RsvBus	GND	AM3	A19	RsvBus
20	GND	IACK	GND	A18	+3.3 V
21	RsvBus	IACKIN	SERCLK (1)	A17	RsvBus
22	GND	IACKOUT	SERDAT (1)	A16	+3.3 V
23	RsvBus	AM4	GND	A15	RsvBus
24	GND	A07	IRQ7	A14	+3.3 V
25	RsvBus	A06	IRQ6	A13	RsvBus
26	GND	A05	IRQ5	A12	+3.3 V
27	RsvBus	A04	IRQ4	A11	LI/I
28	GND	A03	IRQ3	A10	+3.3 V
29	SBB	A02	IRQ2	A09	LI/O
30	GND	A01	IRQ1	A08	+3.3 V
31	SBA	-12 V	+5 V STDBT	+12 V	GND
32	GND	+5 V	+5 V	+5 V	VPC

Pin assignment for J2 connector VME64x					
Pin no.	Pin assignment for J2 connector VME				
	Z	A	B	C	D
1	UD	User def.	+5 V	User def.	UD
2	GND	User def.	GND	User def.	UD
3	UD	User def.	Retry	User def.	UD
4	GND	User def.	A24	User def.	UD
5	UD	User def.	A25	User def.	UD
6	GND	User def.	A26	User def.	UD
7	UD	User def.	A27	User def.	UD
8	GND	User def.	A28	User def.	UD
9	UD	User def.	A29	User def.	UD
10	GND	User def.	A30	User def.	UD
11	UD	User def.	A31	User def.	UD
12	GND	User def.	GND	User def.	UD
13	UD	User def.	+5 V	User def.	UD
14	GND	User def.	D16	User def.	UD
15	UD	User def.	D17	User def.	UD
16	GND	User def.	D18	User def.	UD
17	UD	User def.	D19	User def.	UD
18	GND	User def.	D20	User def.	UD
19	UD	User def.	D21	User def.	UD
20	GND	User def.	D22	User def.	UD
21	UD	User def.	D23	User def.	UD
22	GND	User def.	GND	User def.	UD
23	UD	User def.	D24	User def.	UD
24	GND	User def.	D25	User def.	UD
25	UD	User def.	D26	User def.	UD
26	GND	User def.	D27	User def.	UD
27	UD	User def.	D28	User def.	UD
28	GND	User def.	D29	User def.	UD
29	UD	User def.	D30	User def.	UD
30	GND	User def.	D31	User def.	UD
31	UD	User def.	GND	User def.	UD
32	GND	User def.	+5 V	User def.	UD

Technical specifications



Automatic daisy-chaining J1 and J1/J2

Via the use of connectors with integral mechanical switches, the contact is automatically opened when the daughterboard is inserted, and closed again when it is extracted.



Automatic daisy-chaining VME64x

The second option for automatic daisy-chaining is achieved here by an "or" logic integrated onto the backplane. If the daughterboard is extracted, the logic closes the daisy-chain.

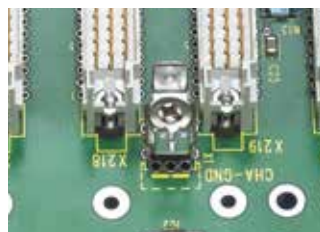

Chassis GND connection

An electrically conductive chassis GND surface is attached to the subracks in the mounting section of the backplane. This facilitates EMC-sealed mounting of the backplane on the subracks. With VME64x, RF linking of the subracks and system earth is achieved via capacitors (10nF, 200 V at each slot). Static charges are discharged via a resistor ($\geq 1 \text{ M}\Omega$). A combined connection component (screw M4 and Faston 2.8 or 6.3 x 0.8 mm) is provided for connection of the enclosure earth.



Power connections

Infeed of the main operating voltage +5 V/+3.3 V and GND is provided via busbars with M6 screw terminal. The auxiliary operating voltages are supplied via double Fastons with additional M4 screw thread. Optimum supply of the daughterboards and hence problem-free operation is ensured, thanks to the arrangement of the infeed modules on the backplane.

Utility connector

The special signals to the power pack and to external LEDs are routed on a separate connector on the backplanes.

A 7-pole, a 10-pole or a 14-pole connector with 2.54 mm spacing is provided, depending on the backplane type.

Pin assignment, 10/14 Pins

GND	1	2	GND Sense (5 V)
+5 V	3	4	+5 V Sense
ACFAIL-	5	6	ACFAIL-
SYSFAIL-	7	8	SYSFAIL-
SYSRESET-	9	10	SYSRESET-
+3.3 V	11	12	+3.3 V Sense
GND	13	14	GND Sense (3.3 V)

J1, J1/J2: 10 pins, VME64x: 14 pins

Geographical address pin assignments (VME64x)

Slot no.	GAP Pin J1-D9	GA4 Pin J1-D17	GA3 Pin J1-D15	GA2 Pin J1-D13	GA1 Pin J1-D11	GA0 Pin J1-D10
1	Open	Open	Open	Open	Open	GND
2	Open	Open	Open	Open	GND	Open
3	GND	Open	Open	Open	GND	GND
4	Open	Open	Open	GND	Open	Open
5	GND	Open	Open	GND	Open	GND
6	GND	Open	Open	GND	GND	Open
7	Open	Open	Open	GND	GND	GND
8	Open	Open	GND	Open	Open	Open
9	GND	Open	GND	Open	Open	GND
10	GND	Open	GND	Open	GND	Open
11	Open	Open	GND	Open	GND	GND
12	GND	Open	GND	GND	Open	Open
13	Open	Open	GND	GND	Open	GND
14	Open	Open	GND	GND	GND	Open
15	GND	Open	GND	GND	GND	GND
16	Open	GND	Open	Open	Open	Open
17	GND	GND	Open	Open	Open	GND
18	GND	GND	Open	Open	GND	Open
19	Open	GND	Open	Open	GND	GND
20	GND	GND	Open	GND	Open	Open
21	Open	GND	Open	GND	Open	GND

Pin assignments J0

Pin no.	Z	A	B	C	D	E	F
1 - 19	GND	User Defined	User Defined	User Defined	User Defined	User Defined	GND

SYSTEM PLATFORMS

VME64x – BACKPLANES

Backplanes VME64x

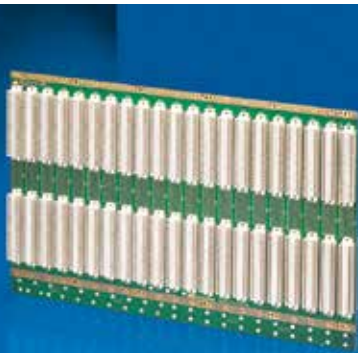
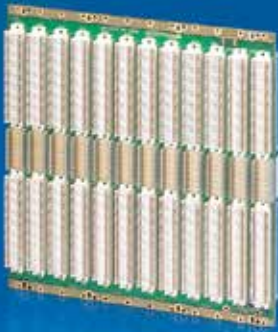

Technical specifications

Number of layers	10	
Layer structure	Optimised for optimum RF performance. Outer layers designed as shielding surface.	
PCB thickness	4.5 mm ± 10 %	
Ohmic resistance of the signal tracks	< 1 Ohm	
Surge impedance Z of the signal tracks	55 Ohm	
Basic power consumption, terminated at both ends	Active: < 200 mA Passive: < 2 A	
Power supply: - Busbar with M6 screw terminal - M4 screw terminal and FASTON 6.3 x 0.8 mm - < 5 slots	+5 V, +3.3 V and 0 V ±12 V, +5 V STBY, ±V1, ±V2 and case FASTON 6.3 x 0.8 mm	
Current carrying capacity of busbar	max. 200 A	
Current carrying capacity of a combined double flat-pin connector/screw terminal	25 A	
Current carrying capacity of a FASTON flat connector	10 A	
Current carrying capacity of the assembly, per slot	+3.3 V	12.5 A
	+5 V	9.0 A
	+12 V	1.5 A
	-12 V	1.5 A
	+5 V STDBY	1.5 A
	+48 V (38 - 75 V)	3.0 A
Termination ON-/IN-board	6 U: active, 6.5 U: active (passive/changeover)	
Installation height	6 U/6.5 U	
Distance between slots	4 HP	
Connectors	Press-fit technique quality class 2, 400 connection cycles 160 pins compatible with C96 P0 spacing 2 mm, 95/133 pins	
Operating temperature range	Active termination 0° ... +70°C Passive termination -40° ... +85°C	
Relative humidity	90%, non-condensing	

VME64x 6 U

Slot	Dimensions		Model No.	
	Height mm	Width mm	without P0 connector	with P0 connector
2	261.7	39.5	9912.423	9912.410
3	261.7	59.5	9912.424	9912.411
4	261.7	80	9912.425	9912.362
5	261.7	100	3687.608	3687.609
6	261.7	120.5	9912.426	9912.412
7	261.7	141	3687.610	3687.611
8	261.7	161.5	9912.427	9912.413
9	261.7	181.5	9904.930	9904.932
10	261.7	202	9904.931	9904.933
11	261.7	222.5	9912.428	9912.414

Slot	Dimensions		Model No.	
	Height mm	Width mm	without P0 connector	with P0 connector
12	261.7	242.5	3686.634	3686.473
13	261.7	263	9912.429	9912.415
14	261.7	283	9912.430	9912.416
15	261.7	303.5	9912.431	9912.417
16	261.7	324	9912.432	9912.418
17	261.7	344	9912.433	9912.419
18	261.7	364.5	9912.434	9912.420
19	261.7	385	9912.435	9912.421
20	261.7	405	9912.436	9912.422
21	261.7	425.5	3686.635	3686.474

VME64x 6.5 U

Slot	Dimensions		Model No.	
	Height mm	Width mm	without P0 connector	with P0 connector
5	283.7	100	9910.012	9910.007
7	283.7	141	9910.013	9910.008
9	283.7	181.5	9910.014	9910.009
10	283.7	202	9904.928	9904.929
12	283.7	242.5	9910.015	9910.010
21	283.7	425.5	9910.016	9910.011

Material

Fibreglass epoxy to IEC 60 249 (type FR4)

Supply includes

Backplane, fully populated.

+ Accessories

For backplane mounting:
Conductive strips, see page 145
Insulating strips, see page 145

Backplanes VME J1/J2 Monolithic



Technical specifications

Number of layers	6
Layer structure	Optimised for optimum RF performance. Outer layers designed as shielding surface.
PCB thickness	3.2 mm ± 10 %
Ohmic resistance of the signal tracks	< 1 Ohm
Surge impedance Z of the signal tracks	60 Ohm
Basic power consumption, terminated at both ends	Active: < 200 mA Passive: < 1.5 A
Power supply: - Busbar with screw terminal M6 - Screw terminal M4 and FASTON 6.3 x 0.8 mm - < 5 slots	+5 V, and 0 V ±12 V, +5 V STBY and case FASTON 6.3 x 0.8 mm
Current carrying capacity of busbar	max. 200 A
Current carrying capacity of a combined double flat-pin connector/screw terminal	25 A
Current carrying capacity of a FASTON flat connector	10 A
Current carrying capacity of the assembly, per slot	+5 V 9.0 A +12 V 1.5 A -12 V 1.5 A +5 V STDBY 1.5 A
Termination ON-/IN-board	active (may be switched to passive)
Installation height	6 U
Distance between slots	4 HP
Connectors	Press-fit technique quality class 2, 400 connection cycles C96
Operating temperature range	Active termination 0° ... +70°C Passive termination -40° ... +85°C
Relative humidity	90%, non-condensing

Slot	Dimensions		Model No.
	Height mm	Width mm	
2	261.7	39.5	3686.495
3	261.7	59.5	3686.496
4	261.7	80	3686.497
5	261.7	100	3686.498
6	261.7	120.5	3686.499
7	261.7	141	3686.500
8	261.7	161.5	3686.501
9	261.7	181.5	3686.502
10	261.7	202	3686.503
11	261.7	222.5	3686.504
12	261.7	242.5	3686.505
13	261.7	263	3686.506
14	261.7	283	3686.507
15	261.7	303.5	3686.508
16	261.7	324	3686.509
17	261.7	344	3686.510
18	261.7	364.5	3686.511
19	261.7	385	3686.512
20	261.7	405	3686.513
21	261.7	425.5	3686.514

Material

Fibreglass epoxy to IEC 60 249 (type FR4)

Supply includes

Backplane, fully populated.

+ Accessories

For backplane mounting:
Conductive strips, see page 145
Insulating strips, see page 145

SYSTEM PLATFORMS

VME – BACKPLANES

VME J1 system bus

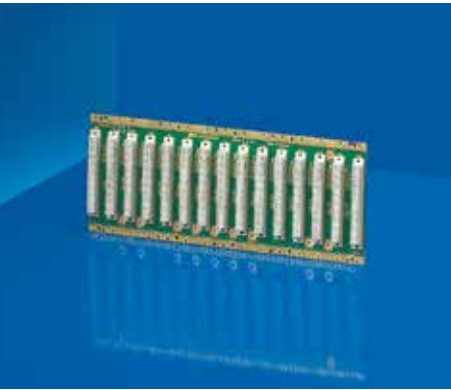

Technical specifications			
	VME J1		VME J2
Number of layers	6		2
Layer structure	Optimised for optimum RF performance, outer layers designed as shielding surface.		
PCB thickness	3.2 mm ± 10 %		3.2 mm ± 10%
Ohmic resistance of the signal tracks	< 1 Ohm		< 1 Ohm
Wellenwiderstand Z der Signalleitungen	60 Ohm		60 Ohm
Surge impedance Z of the signal tracks	Active: < 150 mA Passive: < 1.2 A		Passive: < 0.6 A
Power supply: - M4 screw terminal and FASTON 6.3 x 0.8 mm - < 5 slots	+5 V, 0 V, ±12 V, ±5 V STBY and case FASTON 6.3 x 0.8 mm		x FASTON 6.3 x 0.8 mm
Current carrying capacity of a combined double flat-pin connector/screw terminal	25 A		25 A
Current carrying capacity of a FASTON flat connector	10 A		10 A
Current carrying capacity of the assembly, per slot	+5 V	4.5 A	+5 V
	+12 V	1.5 A	4.5 A
	-12 V	1.5 A	
	+5 V STDBY	1.5 A	
Termination ON-/IN-board	active/passive (changeover)		active/passive (changeover)
Installation height	3 U		3 U
Distance between slots	4 HP		4 HP
Connectors	Press-fit technique quality class 2, 400 connection cycles C96		Press-fit technique quality class 2, 400 connection cycles C96
Operating temperature range	Active termination 0° . . . +70°C Passive termination -40° . . . +85°C		Passive termination -40° . . . +85°C
Relative humidity	90 %, non-condensing		90 %, non-condensing

Slot	Dimensions		Model No.
	Height mm	Width mm	
3	128.4	59.5	3686.555
4	128.4	80	3686.556
5	128.4	100	3686.557
6	128.4	120.5	3686.558
7	128.4	141	3686.559
8	128.4	161.5	3686.560
9	128.4	181.5	3686.561
10	128.4	202	3686.562

Slot	Dimensions		Model No.
	Height mm	Width mm	
12	128.4	242.5	3686.563
13	128.4	263	3686.564
14	128.4	283	3686.565
15	128.4	303.5	3686.566
18	128.4	364.5	3686.567
20	128.4	405	3686.568
21	128.4	425.5	3686.569

Material

Fibreglass epoxy to IEC 60 249 (type FR4)

Supply includes

Backplane, fully populated.

+ Accessories

For backplane mounting:
Conductive strips, see page 145
Insulating strips, see page 145

VME J2 expansion bus



Slot	Dimensions		Model No.
	Height mm	Width mm	
3	128.4	59.5	3686.585
4	128.4	80	3686.586
5	128.4	100	3686.587
6	128.4	120.5	3686.588
7	128.4	141	3686.589
8	128.4	161.5	3686.590
9	128.4	181.5	3686.591
10	128.4	202	3686.592

Slot	Dimensions		Model No.
	Height mm	Width mm	
12	128.4	242.5	3686.593
13	128.4	263	3686.594
14	128.4	283	3686.595
15	128.4	303.5	3686.596
18	128.4	364.5	3686.597
20	128.4	405	3686.598
21	128.4	425.5	3686.599

Material

Fibreglass epoxy to IEC 60 249 (type FR4)

Supply includes

Backplane, fully populated.

+ Accessories

For backplane mounting:
Conductive strips, see page 145
Insulating strips, see page 145

MPS Monitoring electronics



In order to ensure maximum system availability and performance in industrial computers, all hardware components must offer functional reliability. The monitoring electronics for microcomputer packaging systems (MPS) offers a highly flexible, scalable security concept for key parameters such as temperature, voltage and fan speed. At the heart of this concept are intelligent function modules such as controller, temperature, fan and LCD display or LED display modules. The system may be polled, or parameters set via the Internet using remote control functions, thanks to compatibility with the HEITEC CMC-TC monitoring system. Alternatively, this may be executed directly on the MPS system, via a PC, or with the aid of CMC-TC, directly from a control point.

Benefits at a glance:

- Monitoring of temperature, voltage, fan speed and fan alarm
- Flexible, scalable system concept
- Intelligent function modules
- Adjustable temperature limits
- Remote control via the Internet in conjunction with the HEITEC CMC-TC enclosure monitoring system
- Choice of parameter levels
- Internal communications via I²C bus

Controller-Module (CMC & RS232)



Monitoring of system voltage, PSU-status, HeiCool alarm and data transfer of the temperature- and/or fan module via the RS 232 (to PC) or RS422-interface (to CMC-TC).

Packs of	Order No.
1	9909.193

Supply includes

Unit consisting of:
Controller-module, front plate 3 U, 4 HP

Controller-Module (CMC & LAN)



Monitoring of system voltage, PSU-status, HeiCool alarm and data transfer of the temperature- and/or fan module via LAN- (to PC) or RS422- interface (to CMC-TC).

Packs of	Order No.
1	9913.260

Supply includes

Unit consisting of:
Controller-Module, front plate 3 U, 4 HP

SYSTEM PLATFORMS

CPCI/VMEbus – MPS MONITORING

Display- and Controller-Module (CMC & RS232)



Controller-Module:
Monitoring of system voltage, PSU-status, HeiCool alarm and data transfer of the temperature- and/or fan module via RS232- (to PC) or RS422- interface (to CMC-TC).

- Display-Module:**
- Handling via 3 keys: forward, escape, return
 - 3 LEDs: Fan, Temperature, Volt for optical display as sum alarm
 - For displaying temperature, power supply, fan speed
 - Brightness and lightning optionally adjustable with turn on/off function
 - Temperature display in °F/°C
 - LCD (2 x 20 digits) for displaying data details

Packs of	Order No.
1	9912.483

Supply includes

Unit consisting of:
Controller-module, display-Moduel,
Front panel 6 U, 8 HP

LED Display- and Controller Module (CMC & RS232)



Controller-Module:
Monitoring of system voltage, PSU-status, HeiCool alarm and data transfer of the temperature-s and/or fan module via RS232- (to PC) or RS422- interface (to CMC-TC).

- LED Display-Module:**
- + 3.3 V
 - + 5.0 V
 - + 12 V
 - – 12 V
 - 2 x alarm (fan, temperature)
 - Display of system voltage as to critical values
 - Red: voltage deficiency
 - Yellow (1 flash): below limit
 - Yellow (2 flashes): over limit
 - Green: voltage ok

Packs of	Order No.
1	9913.748

Supply includes

Unit consisting of:
Controller-module, display-Moduel,
Front panel 6 U, 4 HP

Temperature-Module



- Up to 2 modules cascable
- Data transfer of each temperature sensor to the controller-module
- Up to 4 temperature sensors
- Internal communication via I²C

Note

Only applicable in connection with Controller-/LCD- or LED-modules

Packs of	Order No.
1	9909.230

Supply includes

Unit consisting of:
Temperature-module, front panel 3 U, 4 HP

LED Display-Module



LED Display-Module:

- + 3.3 V
- + 5.0 V
- + 12 V
- – 12 V
- 2 x alarm (fan, temperature)
- Display of system voltage as to critical values
 - Red: voltage deficiency
 - Yellow (1 flash): below limit
 - Yellow (2 flashes): over limit
 - Green: voltage ok

Packs of	Order No.
1	9912.294

Note

Only applicable in connection with Controller-/Display- or LED-modules

Supply includes

Unit consisting of:
LED-module, front panel 3 U, 4 HP

Fan-Module



Monitoring fan functions

(Attention: requires fan with alarm signal)

Packs of	Order No.
1	9912.293

Note

Only applicable in connection with Controller-/Display- or LED-modules

Supply includes

Unit consisting of:
Fan-module, front panel 3 U, 4 HP

Mains switch



LED Display-module:

- Rocker switch 6 A/250 V, 2-pole, FASTON connections, (4.7 x 0.8 mm)
- VDE, UL, CSA, TÜV, SEMKO, DEMCO, SEV, NEMKO, SETI, BEAB approvals
- Insulation resistance: > 10 MΩ
- Test voltage: 1 kV
- Front panel: 21 x 15 mm
- Cut-out: 19.2 x 12.9 mm
- Installation depth: 17 mm

Max. current	Packs of	Order No.
6 A	1 St.	3687.711

Filtered IEC mains inlet



For mains input

Combination module consisting of an IEC socket to IEC 60 320 and IEC 60 950 with line filter and 5 x 20 mm G fuse holder.

Technical specifications

Metal enclosure for screw mounting
Mains input: via IEC socket
Mains output: via 3 FASTON contacts (L, N, PE, 6.3 x 0.8)
Variants available with or without switch
Temperature range: –25°C to +85°C

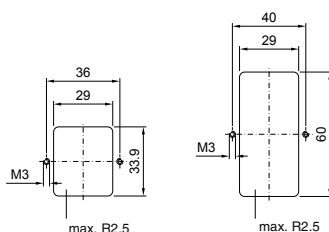

	Order No.	
	with switch	without switch
	3687.709	3687.710
Mains voltage max.	250 V AC	250 V AC
Leakage current	2 x 0.32 mA	∅ 500 µA
Max. current	6 A	6 A
Mounting holes	40 mm	36 mm
Installation depth	90 mm	56 mm
Cut-out	60 x 29 mm	33.9 x 29 mm
Approvals	VDE, SEMKO, SEV, UL, CSA	VDE

LIST OF ORDER NUMBERS

Order No.	Page	Order No.	Page	Order No.	Page	Order No.	Page	Order No.	Page
2089.000	203	3634.740	88, 127	3654.360	202	3684.043	31	3684.162	33
2092.200	203	3634.745	88, 130	3654.370	202	3684.044	31	3684.163	33
2094.200	203	3634.750	88, 130	3658.160	202	3684.045	31	3684.164	33
3606.140	158	3634.770	152	3658.190	202	3684.046	31	3684.165	33
3606.200	158	3634.780	153	3658.210	202	3684.047	31	3684.166	33
3606.300	177	3636.010	57	3659.000	208	3684.048	31	3684.169	33
3606.321	183	3652.000	174	3659.010	215	3684.049	31	3684.170	33
3606.330	178	3652.010	174	3659.020	215	3684.050	31	3684.171	33
3606.550	202	3652.020	174	3659.030	214	3684.051	31	3684.172	33
3606.560	202	3652.030	174	3659.050	208, 214	3684.052	31	3684.173	33
3606.610	202	3652.040	174	3659.060	208, 215	3684.053	31	3684.174	33
3634.060	180	3652.050	174	3659.090	208, 209	3684.054	31	3684.175	33
3634.070	180	3652.060	174	3659.100	210	3684.055	31	3684.176	33
3634.085	87	3652.070	174	3659.110	214	3684.056	31	3684.177	33
3634.100	83	3652.080	174	3659.120	210, 211	3684.057	31	3684.178	33
3634.110	83	3652.200	174	3659.180	214	3684.058	31	3684.179	33
3634.120	83	3652.210	174	3659.190	214	3684.059	31	3684.180	34, 83
3634.130	83	3652.220	174	3659.230	210, 215	3684.060	31	3684.181	34
3634.140	83	3652.230	174	3659.240	215	3684.061	31	3684.187	34
3634.150	83	3652.240	174	3659.250	211, 216	3684.062	32	3684.188	34
3634.160	83	3652.250	174	3659.270	216	3684.063	32	3684.189	34
3634.170	83	3652.260	174	3659.280	216	3684.064	32	3684.190	34, 83
3634.180	83	3652.270	174	3659.290	211, 216	3684.065	32	3684.191	34
3634.190	83	3652.500	110, 180	3659.320	211, 217	3684.072	97	3684.192	34
3634.200	83	3652.510	110, 180	3659.330	211, 217	3684.073	97	3684.193	34
3634.210	83	3652.520	110, 180	3659.340	211	3684.074	97	3684.194	34
3634.220	83	3652.530	110, 180	3659.350	211, 217	3684.075	97	3684.195	34
3634.230	83	3652.600	110, 180	3659.400	211	3684.076	97	3684.196	34
3634.240	83	3652.610	110, 180	3659.410	214	3684.077	97	3684.197	34
3634.250	83	3652.620	110, 180	3659.540	215	3684.078	97	3684.198	34
3634.420	89, 164	3652.630	110, 180	3659.700	212	3684.109	203	3684.204	159
3634.430	202	3653.010	182	3659.710	213	3684.128	33	3684.205	159
3634.435	202	3653.020	182	3659.900	209	3684.129	33	3684.206	151
3634.450	89, 164	3653.030	182	3666.006	222	3684.130	33	3684.207	151
3634.510	86, 143	3653.040	182	3666.007	222	3684.131	33	3684.208	151
3634.600	86, 142	3653.050	182	3666.008	225	3684.132	33	3684.209	151
3634.615	87, 142	3653.060	182	3666.010	57	3684.133	33	3684.210	83, 151
3634.620	86, 143	3653.070	182	3684.019	202	3684.134	34	3684.211	151
3634.625	89, 164	3653.100	182	3684.020	31	3684.135	34	3684.212	151
3634.630	89, 164	3653.110	182	3684.021	31	3684.136	34	3684.213	151
3634.635	89, 164	3653.120	182	3684.022	31	3684.137	34	3684.220	83, 150
3634.640	89, 164	3653.130	182	3684.023	31	3684.138	34	3684.221	150
3634.645	89, 164	3653.140	182	3684.024	31	3684.139	34	3684.222	150
3634.650	89, 164	3653.150	182	3684.025	31	3684.142	33	3684.223	150
3634.655	89, 164	3653.200	182	3684.026	31	3684.143	33	3684.224	150
3634.660	89, 164	3653.210	182	3684.027	31	3684.144	33	3684.225	150
3634.665	90, 164	3653.220	182	3684.028	32	3684.145	33	3684.226	150
3634.670	89, 164	3653.230	182	3684.029	32	3684.146	33	3684.227	150
3634.675	89, 164	3653.240	182	3684.030	32	3684.147	33	3684.228	150
3634.680	89, 164	3653.250	182	3684.031	32	3684.148	34	3684.229	150
3634.685	89, 164	3653.300	182	3684.032	32	3684.149	34	3684.233	202
3634.690	89, 164	3653.310	182	3684.033	32	3684.150	34	3684.234	148
3634.695	88, 127	3653.320	182	3684.034	31	3684.151	34	3684.236	146
3634.700	88, 127	3653.330	182	3684.035	31	3684.152	34	3684.237	146
3634.705	88, 127	3653.340	182	3684.036	31	3684.153	34	3684.238	146
3634.710	88, 127	3653.350	182	3684.037	32	3684.156	33	3684.239	146
3634.715	88, 127	3654.300	202	3684.038	32	3684.157	33	3684.240	146
3634.720	88, 127	3654.320	202	3684.039	32	3684.158	33	3684.241	146
3634.725	88, 127	3654.330	202	3684.040	32	3684.159	33	3684.242	146
3634.730	88, 127	3654.340	202	3684.041	32	3684.160	33	3684.243	146
3634.735	88, 127	3654.350	202	3684.042	32	3684.161	33	3684.244	146

LIST OF ORDER NUMBERS

Order No.	Page	Order No.	Page	Order No.	Page	Order No.	Page	Order No.	Page
3684.245	147	3684.321	187	3684.384	166	3684.541	48, 126	3684.620	49, 128
3684.246	147	3684.322	187	3684.385	166	3684.542	48, 126	3684.621	49, 128
3684.247	179	3684.323	201	3684.386	166	3684.543	48, 126	3684.622	49, 128
3684.248	179	3684.324	201	3684.387	166	3684.544	48, 126	3684.623	49, 128
3684.249	179	3684.325	159	3684.388	166	3684.545	48, 126	3684.624	49, 128
3684.250	83, 179	3684.326	159	3684.389	166	3684.546	48, 126	3684.625	49, 128
3684.251	179	3684.328	169	3684.410	171	3684.547	48, 126	3684.626	49, 128
3684.252	179	3684.330	165	3684.411	172	3684.548	48, 126	3684.627	49, 128
3684.253	179	3684.331	165	3684.413	166	3684.549	48, 126	3684.628	49, 128
3684.254	179	3684.332	165	3684.414	166	3684.550	48, 126	3684.629	49, 128
3684.255	179	3684.333	165	3684.415	166	3684.551	48, 126	3684.630	49, 128
3684.256	179	3684.334	165	3684.416	166	3684.552	48, 126	3684.631	49, 128
3684.257	179	3684.335	165	3684.417	166	3684.553	48, 126	3684.632	49, 128
3684.258	179	3684.336	165	3684.418	166	3684.554	48, 126	3684.633	57
3684.259	179	3684.337	165	3684.419	166	3684.560	132	3684.634	57
3684.260	179	3684.338	165	3684.420	166	3684.561	132	3684.635	57
3684.261	179	3684.339	165	3684.421	166	3684.562	132	3684.636	57
3684.262	179	3684.340	165	3684.422	166	3684.565	133	3684.637	57
3684.263	179	3684.341	165	3684.423	166	3684.566	133	3684.638	57
3684.264	179	3684.342	165	3684.424	166	3684.567	133	3684.639	57
3684.265	179	3684.343	165	3684.425	166	3684.570	41, 135	3684.640	57
3684.266	179	3684.344	166	3684.426	166	3684.571	41, 135	3684.643	55, 146
3684.267	179	3684.345	166	3684.427	166	3684.572	41, 135	3684.644	55, 146
3684.268	179	3684.346	166	3684.428	166	3684.579	44, 138	3684.645	55, 146
3684.269	179	3684.347	166	3684.429	166	3684.580	138	3684.654	154
3684.272	179	3684.348	166	3684.430	166	3684.581	44, 138	3684.655	154
3684.273	179	3684.349	166	3684.431	166	3684.582	44, 138	3684.656	154
3684.274	179	3684.350	166	3684.432	166	3684.584	46, 140	3684.657	154
3684.275	179	3684.351	166	3684.433	166	3684.587	46, 140	3684.658	154
3684.276	179	3684.352	166	3684.435	202	3684.588	46, 140	3684.659	154
3684.277	179	3684.353	166	3684.482	202	3684.589	46, 140	3684.660	154
3684.278	179	3684.354	166	3684.511	48, 126	3684.590	140	3684.661	154
3684.279	179	3684.355	166	3684.512	48, 126	3684.591	140	3684.662	154
3684.280	179	3684.356	166	3684.513	48, 126	3684.592	34, 132	3684.663	154
3684.281	187	3684.357	166	3684.514	48, 126	3684.593	34, 132	3684.664	154
3684.282	187	3684.358	165	3684.515	48, 126	3684.594	34, 132	3684.665	154
3684.283	187	3684.359	165	3684.516	48, 126	3684.595	34, 132	3684.666	154
3684.284	188	3684.360	165	3684.517	48, 126	3684.596	34, 132	3684.668	155
3684.285	188	3684.361	165	3684.518	48, 126	3684.596	34, 132	3684.669	155
3684.286	188	3684.362	165	3684.519	48, 126	3684.597	144	3684.670	157
3684.287	188	3684.363	165	3684.520	48, 126	3684.598	144	3684.672	157
3684.291	180	3684.364	165	3684.521	48, 126	3684.599	144	3684.673	157
3684.292	180	3684.365	165	3684.522	48, 126	3684.600	144	3684.674	157
3684.293	180	3684.366	165	3684.523	48, 126	3684.601	144	3684.675	157
3684.294	180	3684.367	165	3684.524	48, 126	3684.602	144	3684.676	157
3684.295	180	3684.368	165	3684.525	48, 126	3684.603	144	3684.677	157
3684.298	110, 180	3684.369	165	3684.526	48, 126	3684.604	144	3684.678	150
3684.299	110, 180	3684.370	165	3684.527	48, 126	3684.605	144	3684.679	150
3684.300	110, 180	3684.371	165	3684.528	48, 126	3684.606	144	3684.680	161
3684.301	110, 180	3684.372	165	3684.529	48, 126	3684.607	144	3684.681	161
3684.302	180	3684.373	165	3684.530	48, 126	3684.608	144	3684.683	50, 161
3684.304	189	3684.374	166	3684.531	48, 126	3684.609	144	3684.684	50, 161
3684.305	189	3684.375	166	3684.532	48, 126	3684.610	144	3684.685	50, 161
3684.306	189	3684.376	166	3684.533	48, 126	3684.611	145	3684.686	50, 161
3684.307	189	3684.377	166	3684.534	48, 126	3684.612	145	3684.687	50, 161
3684.311	189	3684.378	166	3684.535	48, 126	3684.614	49, 128	3684.688	50, 161
3684.312	189	3684.379	166	3684.536	48, 126	3684.615	49, 128	3684.689	50, 161
3684.313	189	3684.380	166	3684.537	48, 126	3684.616	49, 128	3684.691	50, 161
3684.314	189	3684.381	166	3684.538	48, 126	3684.617	49, 128	3684.692	50, 161
3684.317	186	3684.382	166	3684.539	48, 126	3684.618	49, 128	3684.693	50, 161
3684.320	187	3684.383	166	3684.540	48, 126	3684.619	49, 128	3684.694	50, 161

LIST OF ORDER NUMBERS

Order No.	Page	Order No.	Page	Order No.	Page	Order No.	Page	Order No.	Page
3684.695	50, 161	3684.892	178	3685.179	179	3685.272	46, 140	3685.522	167
3684.696	50, 161	3684.893	178	3685.180	179	3685.273	145	3685.524	167
3684.698	50, 161	3684.894	178	3685.181	179	3685.274	145	3685.525	167
3684.700	50, 161	3684.895	178	3685.182	179	3685.275	145	3685.526	167
3684.701	50, 161	3684.896	178	3685.183	179	3685.276	57	3685.527	167
3684.702	50, 161	3684.897	178	3685.184	179	3685.277	57	3685.528	167
3684.703	50, 161	3684.898	178	3685.185	179	3685.279	172	3685.529	167
3684.714	52, 162	3684.899	178	3685.186	179	3685.280	172	3685.530	167
3684.715	52, 162	3684.900	178	3685.187	179	3685.281	31	3685.532	167
3684.716	52, 162	3684.901	178	3685.188	179	3685.282	203	3685.533	167
3684.717	52, 162	3684.902	178	3685.189	179	3685.282	203	3685.534	167
3684.718	52, 162	3684.903	178	3685.190	179	3685.286	150	3685.535	167
3684.719	52, 162	3684.904	178	3685.191	179	3685.289	203	3685.536	167
3684.720	52, 162	3684.905	178	3685.192	179	3685.290	203	3685.537	167
3684.721	52, 162	3684.906	178	3685.193	179	3685.291	151	3685.538	167
3684.722	52, 162	3684.907	178	3685.194	179	3685.292	151	3685.540	167
3684.723	52, 162	3684.908	178	3685.195	179	3685.294	185	3685.541	167
3684.724	52, 162	3684.909	178	3685.196	179	3685.302	187	3685.542	167
3684.725	52, 162	3684.910	178	3685.197	203	3685.303	187	3685.543	167
3684.726	52, 163	3684.911	178	3685.198	177	3685.304	197	3685.544	167
3684.727	52, 163	3684.912	178	3685.229	56	3685.306	197	3685.545	167
3684.728	52, 163	3684.913	178	3685.231	31	3685.307	197	3685.546	167
3684.729	52, 163	3684.914	178	3685.232	31	3685.319	170	3685.548	173
3684.730	52, 163	3684.915	178	3685.233	31	3685.328	200	3685.549	173
3684.731	52, 163	3684.916	178	3685.234	31	3685.329	200	3685.550	173
3684.732	52, 163	3684.917	178	3685.235	32	3685.331	200	3685.551	173
3684.733	52, 163	3684.918	178	3685.236	32	3685.332	200	3685.552	173
3684.734	52, 163	3684.919	178	3685.237	32	3685.348	179	3685.553	173
3684.735	52, 163	3684.920	178	3685.238	31	3685.349	179	3685.554	173
3684.736	163	3684.921	178	3685.239	31	3685.350	178	3685.555	173
3684.737	163	3684.922	178	3685.240	31	3685.429	178	3685.556	173
3684.738	178	3684.923	178	3685.241	33	3685.490	176	3685.557	173
3684.739	178	3684.924	178	3685.242	33	3685.491	176	3685.558	173
3684.740	178	3684.925	178	3685.243	33	3685.492	176, 184	3685.559	173
3684.741	178	3684.926	178	3685.244	33	3685.493	176	3685.560	173
3684.742	178	3684.927	178	3685.245	50, 161	3685.494	176, 184	3685.561	173
3684.743	178	3684.928	178	3685.246	50, 161	3685.495	176	3685.562	173
3684.744	178	3684.929	178	3685.247	50, 161	3685.496	176	3685.563	173
3684.745	178	3684.930	178	3685.248	50, 161	3685.497	176	3685.564	173
3684.746	178	3684.953	155	3685.249	50, 161	3685.498	176	3685.566	173
3684.747	178	3684.954	155	3685.250	50, 161	3685.499	176	3685.567	173
3684.748	178	3684.955	34, 132	3685.251	50, 161	3685.500	167	3685.568	173
3684.807	56, 147	3684.956	34, 132	3685.252	50, 161	3685.501	167	3685.569	175
3684.808	147	3684.957	50, 161	3685.253	50, 161	3685.502	167	3685.570	175
3684.812	187	3684.958	50, 161	3685.254	50, 161	3685.503	167	3685.571	175
3684.813	187	3684.960	34, 132	3685.256	203	3685.504	167	3685.572	175
3684.814	187	3684.961	39, 133	3685.257	155	3685.505	167	3685.573	175
3684.839	188	3684.962	41, 135	3685.258	155	3685.506	167	3685.574	175
3684.840	188	3684.963	44, 138	3685.259	155	3685.508	167	3685.575	175
3684.841	188	3684.964	46, 140	3685.260	157	3685.509	167	3685.576	175
3684.842	188	3684.965	144	3685.261	157	3685.510	167	3685.577	175
3684.870	187	3684.966	144	3685.262	157	3685.511	167	3685.578	175
3684.871	187	3684.974	56, 147	3685.263	157	3685.512	167	3685.579	175
3684.872	187	3684.975	56, 147	3685.264	157	3685.513	167	3685.580	175
3684.885	178	3684.976	178	3685.265	157	3685.514	167	3685.581	175
3684.886	178	3684.977	178	3685.266	172	3685.516	167	3685.582	175
3684.887	178	3685.000	172	3685.267	34, 132	3685.517	167	3685.583	175
3684.888	178	3685.097	203	3685.268	41, 135	3685.518	167	3685.584	175
3684.889	178	3685.146	172	3685.269	39, 133	3685.519	167	3685.585	175
3684.890	178	3685.177	179	3685.270	44, 138	3685.520	167	3685.586	175
3684.891	178	3685.178	179	3685.271	144	3685.521	167	3685.587	168

LIST OF ORDER NUMBERS

Order No.	Page	Order No.	Page	Order No.	Page	Order No.	Page	Order No.	Page
3685.588	168	3685.660	185	3685.748	177	3685.896	48, 126	3686.568	254
3685.589	168	3685.661	185	3685.749	177	3685.897	48, 126	3686.569	254
3685.590	168	3685.662	185	3685.750	177	3685.898	48, 126	3686.570	240, 241
3685.591	173	3685.663	185	3685.751	177	3685.899	48, 126	3686.572	172
3685.592	173	3685.664	185	3685.752	177	3685.959	48, 126	3686.573	172
3685.595	176	3685.665	185	3685.753	177	3685.966	172	3686.574	172
3685.596	176	3685.667	185	3685.754	177	3685.967	172	3686.585	254
3685.597	176	3685.668	185	3685.755	177	3685.985	38, 132	3686.586	254
3685.598	176	3685.669	185	3685.756	177	3685.991	41, 135	3686.587	254
3685.599	176	3685.670	185	3685.757	177	3686.005	46, 140	3686.588	254
3685.600	176	3685.671	185	3685.758	177	3686.037	172	3686.589	254
3685.601	176	3685.672	185	3685.759	155	3686.063	155	3686.590	254
3685.602	176	3685.673	185	3685.761	176, 184	3686.136	156	3686.591	254
3685.603	176	3685.674	185	3685.762	176, 184	3686.137	156	3686.592	254
3685.604	176	3685.675	185	3685.763	176	3686.138	179	3686.593	254
3685.605	177	3685.676	185	3685.764	185	3686.139	179	3686.594	254
3685.606	177	3685.677	185	3685.765	185	3686.140	179	3686.595	254
3685.607	177	3685.678	185	3685.766	185	3686.149	144	3686.596	254
3685.608	177	3685.679	185	3685.767	184, 185	3686.159	45, 139	3686.597	254
3685.609	177	3685.680	185	3685.768	185	3686.191	45, 139	3686.598	254
3685.610	177	3685.681	185	3685.769	184, 185	3686.329	193	3686.599	254
3685.611	177	3685.683	184	3685.770	185	3686.359	193	3686.629	196
3685.612	177	3685.684	184	3685.771	185	3686.469	197	3686.634	252
3685.613	177	3685.685	184	3685.772	185	3686.471	197	3686.635	252
3685.614	50, 177	3685.686	184	3685.773	185	3686.472	197	3686.643	190
3685.615	177	3685.687	184	3685.774	185	3686.473	252	3686.644	190
3685.616	177	3685.688	184	3685.775	185	3686.474	252	3686.645	190
3685.617	177	3685.689	184	3685.776	185	3686.495	253	3686.646	190
3685.618	177	3685.690	184	3685.777	185	3686.496	253	3686.647	191
3685.626	172	3685.691	184	3685.783	151	3686.497	253	3686.648	191
3685.627	172	3685.692	184	3685.784	151	3686.498	253	3686.649	191
3685.628	185	3685.693	184	3685.785	151	3686.499	253	3686.650	191
3685.629	184, 185	3685.694	184	3685.786	151	3686.500	253	3686.655	192
3685.630	184, 185	3685.695	184	3685.787	151	3686.501	253	3686.656	192
3685.630	184, 185	3685.696	184	3685.788	151	3686.502	253	3686.657	192
3685.631	184, 185	3685.697	184	3685.789	56	3686.503	253	3686.658	190
3685.632	185	3685.698	184	3685.790	157	3686.504	253	3686.659	190
3685.633	184, 185	3685.699	184	3685.793	48, 126	3686.505	253	3686.805	186
3685.634	184, 185	3685.700	184	3685.794	48, 126	3686.506	253	3686.900	168
3685.635	184, 185	3685.701	184	3685.795	48, 126	3686.507	253	3686.901	168
3685.636	184	3685.702	184	3685.796	48, 126	3686.508	253	3686.902	168
3685.637	184	3685.703	184	3685.797	48, 126	3686.509	253	3686.903	168
3685.638	184	3685.704	184	3685.798	48, 126	3686.510	253	3686.904	168
3685.639	184	3685.705	184	3685.799	48, 126	3686.511	253	3686.905	168
3685.640	184	3685.706	184	3685.805	172	3686.512	253	3686.906	168
3685.641	184	3685.707	184	3685.813	161, 162	3686.513	253	3686.907	168
3685.642	50, 161	3685.708	184	3685.814	161, 162	3686.514	253	3686.908	169
3685.645	184, 185	3685.709	184	3685.824	172	3686.536	171	3686.909	169
3685.646	184, 185	3685.710	184	3685.850	48, 126	3686.555	254	3686.916	203
3685.648	184, 185	3685.711	184	3685.851	50, 161	3686.556	254	3686.917	203
3685.649	184, 185	3685.713	185	3685.852	50, 161	3686.557	254	3686.919	45, 139
3685.650	185	3685.714	185	3685.853	50, 161	3686.558	254	3686.924	203
3685.651	185	3685.715	185	3685.855	161, 162	3686.559	254	3686.973	55, 146
3685.652	185	3685.716	185	3685.856	51, 162	3686.560	254	3686.974	55, 146
3685.653	185	3685.717	185	3685.857	51, 162	3686.561	254	3686.975	55, 146
3685.654	185	3685.718	185	3685.890	48	3686.562	254	3686.976	55, 146
3685.655	185	3685.743	48, 126	3685.891	48, 126	3686.563	254	3686.977	55, 146
3685.656	185	3685.744	48, 126	3685.892	48, 126	3686.564	254	3686.978	55, 146
3685.657	185	3685.745	48, 127	3685.893	48, 126	3686.565	254	3686.979	55, 146
3685.658	185	3685.746	177	3685.894	48, 126	3686.566	254	3686.980	55, 146
3685.659	185	3685.747	177	3685.895	48, 126	3686.567	254	3686.981	55, 146

LIST OF ORDER NUMBERS

Order No.	Page	Order No.	Page	Order No.	Page	Order No.	Page	Order No.	Page
3686.989	183	3687.615	191	3687.687	67, 77	3688.111	63, 130	3689.307	238
3687.014	160	3687.618	50, 161	3687.688	67, 77	3688.112	64	3689.308	238
3687.015	203	3687.619	50, 161	3687.689	67, 77	3688.113	64	3689.309	238
3687.020	203	3687.620	50, 161	3687.690	67, 77	3688.114	59	3689.310	238
3687.021	202	3687.621	50, 161	3687.691	67, 77	3688.115	59	3689.311	238
3687.050	203	3687.623	50, 161	3687.692	53, 163	3688.116	59	3689.312	238
3687.051	203	3687.624	53, 163	3687.709	257	3688.117	59	3689.313	238
3687.052	160	3687.625	53, 163	3687.710	257	3688.118	199, 211	3689.314	239
3687.146	203	3687.626	161, 162	3687.711	257	3688.121	211	3689.315	239
3687.519	185, 202	3687.627	50, 161	3687.724	40, 134	3688.123	211	3689.316	239
3687.520	184	3687.628	50, 161	3687.726	154	3688.130	199	3689.317	239
3687.521	184	3687.629	50, 161	3687.739	153	3688.528	198	3689.318	239
3687.522	184	3687.630	51, 162	3687.814	97	3688.603	240	3689.319	239
3687.523	184	3687.631	51, 162	3687.815	97	3688.606	55, 146	3689.320	239
3687.524	184	3687.633	51, 162	3687.816	97	3688.607	240	3689.321	239
3687.525	184	3687.634	51, 162	3687.817	97	3688.608	241	3689.322	239
3687.526	154	3687.635	51, 162	3687.818	97	3688.609	55, 146	3689.323	239
3687.527	154	3687.637	51, 162	3687.819	97	3688.610	55, 111	3689.324	239
3687.528	154	3687.638	51, 162	3687.820	97	3688.611	55, 111	3689.325	239
3687.529	173	3687.639	51, 162	3687.821	97	3688.612	55, 146	3689.326	239
3687.530	173	3687.640	53, 163	3687.822	97	3688.613	55, 146	3689.327	239
3687.531	173	3687.641	53, 163	3687.823	97	3688.614	55, 146	3689.329	241
3687.536	184	3687.642	53, 163	3687.832	156	3688.615	55, 146	3689.330	241
3687.537	184	3687.643	53, 163	3687.742	75	3688.616	55, 146	3689.331	241
3687.538	184	3687.644	53, 163	3687.743	73	3688.633	55, 146	3689.332	241
3687.539	184	3687.645	53, 163	3687.744	75	3688.634	55, 146	3750.000	114
3687.545	174	3687.646	53, 163	3687.746	73	3688.658	180	3750.002	114
3687.555	184	3687.647	53, 163	3687.747	73	3688.659	181	3750.004	114
3687.556	184	3687.648	53, 163	3687.748	73	3688.660	181	3750.030	114
3687.557	184	3687.649	53, 163	3687.749	73	3688.661	181	3750.032	114
3687.558	184	3687.650	53, 163	3687.750	75	3688.662	181	3750.034	114
3687.559	184	3687.651	53, 163	3687.751	75	3688.663	181	3750.100	113
3687.560	184	3687.652	53, 163	3687.776	73	3688.695	198	3750.102	113
3687.561	184	3687.655	176	3687.777	73	3688.709	203	3750.104	113
3687.562	184	3687.656	176	3687.800	73	3688.770	169	3750.110	113
3687.563	184	3687.657	176	3687.924	158, 193	3688.771	169	3750.112	113
3687.564	184	3687.658	176	3687.932	172	3688.772	169	3750.114	113
3687.565	184	3687.659	176	3687.933	172	3688.773	169	3750.200	113
3687.566	184	3687.660	176	3687.934	172	3688.780	170	3750.202	113
3687.567	184	3687.661	176	3687.936	156	3688.781	170	3750.204	113
3687.568	184	3687.662	176	3687.937	156	3688.784	170	3750.210	113
3687.574	144	3687.663	176	3687.951	156	3688.785	170	3750.212	113
3687.575	144	3687.664	176	3687.955	172	3688.786	171	3750.214	113
3687.576	144	3687.665	201	3687.956	160	3688.787	171	3750.220	113
3687.577	144	3687.666	201	3688.000	34	3688.790	171	3750.222	113
3687.585	184	3687.667	67, 77	3688.001	39, 133	3688.791	171	3750.224	113
3687.587	184	3687.668	67, 77	3688.002	41, 135	3689.036	156	3750.300	113
3687.588	184	3687.669	67, 77	3688.003	44, 138	3689.089	155	3750.302	113
3687.589	185	3687.670	67, 77	3688.004	46, 140	3689.090	156	3750.304	113
3687.590	185	3687.671	77	3688.005	154	3689.091	155	3750.310	114
3687.591	185	3687.672	77	3688.100	63, 127	3689.092	156	3750.312	114
3687.600	46, 140	3687.673	77	3688.101	63, 127	3689.093	155	3750.314	114
3687.601	46, 140	3687.674	77	3688.102	63, 127	3689.097	156	3750.320	114
3687.602	46, 140	3687.677	53, 163	3688.103	63, 127	3689.098	156	3750.322	114
3687.603	46, 140	3687.680	67, 77	3688.104	42, 62	3689.300	238	3750.324	114
3687.609	252	3687.681	67, 77	3688.105	64, 164	3689.301	238	3750.330	114
3687.610	252	3687.682	67, 77	3688.106	64, 164	3689.302	238	3750.332	114
3687.611	252	3687.683	67, 77	3688.107	64, 164	3689.303	238	3750.334	114
3687.612	191	3687.684	67, 77	3688.108	64, 164	3689.304	238	3750.340	114
3687.613	191	3687.685	67, 77	3688.109	64, 164	3689.305	238	3750.342	114
3687.614	191	3687.686	67, 77	3688.110	63, 130	3689.306	238	3750.344	114

LIST OF ORDER NUMBERS

Order No.	Page	Order No.	Page	Order No.	Page	Order No.	Page	Order No.	Page
3750.350	113	3750.922	114	3751.810	119	3981.942	107	3983.000	102
3750.352	113	3750.924	114	3751.820	118	3981.950	107	3983.010	102
3750.354	113	3750.930	114	3751.830	118	3981.951	107	3983.020	102
3750.360	113	3750.932	114	3751.850	120	3981.952	107	3983.030	102
3750.362	113	3750.934	114	3751.852	120	3981.960	107	3983.040	104
3750.364	113	3751.100	114, 121	3751.854	120	3981.970	106	3983.050	104
3750.400	113	3751.120	114, 121	3751.900	118	3982.000	101	3983.060	104
3750.402	113	3751.130	114, 121	3751.910	118	3982.010	101	3983.070	104
3750.404	113	3751.150	114, 121	3751.920	118	3982.020	101	3983.080	104
3750.410	114	3751.160	114, 121	3751.930	118	3982.030	101	3983.090	104
3750.412	114	3751.170	114, 121	3798.000	118	3982.040	103	3983.100	104
3750.414	114	3751.180	114, 121	3901.000	109	3982.050	103	3983.110	106
3750.420	114	3751.200	120	3919.000	108	3982.060	103	3983.120	106
3750.422	114	3751.202	120	3981.200	108	3982.070	103	3983.130	106
3750.424	114	3751.204	120	3981.210	108	3982.080	103	3983.140	106
3750.430	114	3751.210	120	3981.220	108	3982.090	103	3983.150	106
3750.432	114	3751.212	120	3981.230	108	3982.100	103	3983.160	106
3750.434	114	3751.214	120	3981.240	108	3982.110	105	3983.170	106
3750.440	114	3751.250	118	3981.260	108	3982.120	105	3983.190	106
3750.442	114	3751.260	118	3981.270	108	3982.130	105	3983.290	102
3750.444	114	3751.270	118	3981.280	108	3982.140	105	3983.300	102
3750.450	113	3751.300	119	3981.290	108	3982.150	105	7094.600	203
3750.452	113	3751.310	119	3981.300	109	3982.160	105	9687.608	252
3750.454	113	3751.320	119	3981.310	109	3982.170	105	9810.337	240, 241
3750.600	114	3751.330	119	3981.320	109	3982.190	105	9810.338	240, 241
3750.602	114	3751.340	119	3981.330	109	3982.300	101	9901.417	202
3750.604	114	3751.350	119	3981.340	109	3982.370	108	9901.021	48, 127
3750.610	114	3751.360	120	3981.350	109	3982.380	108	9901.023	48, 127
3750.612	114	3751.370	120	3981.360	109	3982.390	108	9901.816	144
3750.614	114	3751.380	120	3981.370	109	3982.700	107	9901.991	139
3750.620	114	3751.400	117	3981.380	109	3982.701	107	9902.240	155
3750.622	114	3751.410	117	3981.390	111	3982.702	107	9904.131	240
3750.624	114	3751.420	117	3981.400	111	3982.710	107	9904.745	133
3750.630	114	3751.450	117	3981.410	111	3982.711	107	9904.928	252
3750.632	114	3751.460	117	3981.500	111	3982.712	107	9904.929	252
3750.634	114	3751.500	116	3981.700	107	3982.720	107	9904.930	252
3750.640	114	3751.510	116	3981.701	107	3982.730	107	9904.931	252
3750.642	114	3751.520	116	3981.702	107	3982.740	107	9904.932	252
3750.644	114	3751.530	114, 121	3981.710	107	3982.741	107	9904.933	252
3750.650	114	3751.540	114, 121	3981.711	107	3982.742	107	9905.105	240
3750.652	114	3751.600	114, 121	3981.712	107	3982.750	107	9905.574	172
3750.654	114	3751.610	114, 121	3981.720	107	3982.751	107	9905.990	172
3750.700	114	3751.620	114, 121	3981.730	107	3982.752	107	9906.727	48, 127
3750.702	114	3751.630	114, 121	3981.740	107	3982.760	107	9906.914	48, 127
3750.704	114	3751.640	116	3981.741	107	3982.770	107	9907.699	227
3750.710	114	3751.650	116	3981.742	107	3982.900	107	9908.721	38, 132
3750.712	114	3751.660	116	3981.750	107	3982.901	107	9908.722	40, 134
3750.714	114	3751.670	116	3981.751	107	3982.902	107	9908.723	42, 136
3750.720	114	3751.680	116	3981.752	107	3982.910	107	9909.193	255
3750.722	114	3751.690	116	3981.760	107	3982.911	107	9909.230	256
3750.724	114	3751.700	116	3981.770	107	3982.912	107	9909.483	235
3750.730	114	3751.710	116	3981.900	107	3982.920	107	9909.484	247
3750.732	114	3751.720	116	3981.901	107	3982.930	107	9910.007	252
3750.734	114	3751.730	116	3981.902	107	3982.940	107	9910.008	252
3750.900	114	3751.740	116	3981.910	107	3982.941	107	9910.009	252
3750.902	114	3751.750	116	3981.911	107	3982.942	107	9910.010	252
3750.904	114	3751.760	116	3981.912	107	3982.950	107	9910.011	252
3750.910	114	3751.770	116	3981.920	107	3982.951	107	9910.012	252
3750.912	114	3751.780	116	3981.930	107	3982.952	107	9910.013	252
3750.914	114	3751.790	116	3981.940	107	3982.960	107	9910.014	252
3750.920	114	3751.800	119	3981.941	107	3982.970	107	9910.015	252

LIST OF ORDER NUMBERS

Order No.	Page	Order No.	Page	Order No.	Page		
9910.016	252	9912.522	137	9921.884	148		
9910.944	232	9912.523	44	9921.885	148		
9910.945	232	9912.828	153	9921.942	146		
9910.946	233	9913.260	255	9921.943	146		
9910.947	234	9913.748	256	9921.944	146		
9910.948	233	9914.268	79, 129	9921.945	145, 147		
9910.949	246	9916.222	199, 211	9921.946	108		
9910.950	246	9916.676	110	9921.947	108		
9910.954	246	9918.119	121	9921.948	108		
9910.955	246	9918.120	121	9921.949	108		
9910.956	247	9918.121	121	9921.950	108		
9910.957	247	9918.122	121	9921.951	108		
9910.958	248	9918.123	121	9921.952	108		
9910.959	248	9918.125	121	9921.953	108		
9910.960	249	9918.814	152	9921.954	108		
9911.220	227	9918.815	152	9921.666	211		
9911.570	227	9918.816	152	9921.879	164		
9911.571	227	9918.817	152				
9911.758	222	9918.818	152				
9911.760	222	9918.819	152				
9911.803	223	9918.820	152				
9911.885	226	9918.821	152				
9911.886	226	9919.472	116				
9911.887	226	9919.605	242				
9911.888	226	9919.795	99				
9911.889	226	9919.796	99				
9911.890	226	9919.797	99				
9911.891	227	9919.798	99				
9911.892	227	9919.799	99				
9911.893	227	9919.800	99				
9912.293	257	9919.834	158				
9912.294	257	9919.911	243				
9912.362	252	9919.912	243				
9912.410	252	9919.999	97				
9912.411	252	9920.069	137				
9912.412	252	9921.685	149				
9912.413	252	9921.710	149				
9912.414	252	9921.721	79, 129				
9912.415	252	9921.722	148				
9912.416	252	9921.723	148				
9912.417	252	9921.724	148				
9912.418	252	9921.725	79, 129				
9912.419	252	9921.726	79, 129				
9912.420	252	9921.788	132				
9912.421	252	9921.789	132				
9912.422	252	9921.790	133				
9912.423	252	9921.791	133				
9912.424	252	9921.793	132				
9912.425	252	9921.795	134				
9912.426	252	9921.798	133				
9912.427	252	9921.799	133				
9912.428	252	9921.803	142				
9912.429	252	9921.860	77				
9912.430	252	9921.861	77				
9912.431	252	9921.862	77				
9912.432	252	9921.863	77				
9912.433	252	9921.864	77				
9912.434	252	9921.865	77				
9912.435	252	9921.866	77				
9912.436	252	9921.867	77				
9912.483	256	9921.883	148				

LIST OF TECHNICAL TERMS

A

	Page
Accessories	
– for subracks	126
– CPCI/VMEbus	257
– MicroTCA	225
– HeiCase	116
– HeiPac Vario-Module	107
AC-fans	
– for subracks	190
– for microcomputer systems	190
Adaptor	65
Adaptor rail	
– rear, centre (E)	140
AdvancedMC	
– Face Plates	226
– Filler Sheets	227
Air baffle	187
Air block panel	158
Air partition	187
Aluminium front door	
– vertically hinged, for HeiCase	119
Aluminium centre part	
– for three-part guide rails	157
Assembly parts	
– for Electronic-Packaging	202
AT/ATX power supply	199
ATX Industrial PCs	210

B

	Page
Backplane 9 U Monolithic with power supply connector	241
Backplane VME J1/J2 Monolithic	253
Backplane	
– CPCI	238
– CPCISerial	242
– VME	253
– VME64x	252
– VMEbus, technical specification	250
Bottom covers	
– for HeiPac Vario-Module	107

C

	Page
Card retainer	215
Carrying handle/support stand	
– for HeiPac Vario-Module	111
Carrying Handles	
– for HeiCase	118
– for HeiPac Vario-Module	109

Climate Control	186
Components for EMC Installation, for subracks	146
Conductive strip (H)	145
Contact strip, EMC	146
Connection cable	
– for AC fans	191
Verbindungsstift	
– for injector/extractor handles types IV, IVs and VII	170
Contact springs	154
Controller modules (CMC & LAN)	255
Controller modules (CMC & RS232)	255
Conversion module	227
Covers	
– for lateral space	173
– for drives	214
– for HeiPac Vario-Module	107
– for mezzanine front panels	181
– for subracks	161
CPCI	
– Backplane	238
– Busplatinen, technical specification	236
– Rack-mount systems	230
– Accessories	257
CPCI power supply	
– Open Frame 400 W	196
– Plug-in	197
CPCI/VMEbus	
– MPS monitoring	255
– Accessories	257
CubeTCA	224

D

	Page
DC-fan	
– for subracks	191
– for rear panels	216
Display- and controller-module (CMC & RS232)	256
Door cut-out trim	
– for subracks	180
Drive holder	215

E

	Page
Earthingset for HeiPac Vario-Module	110
Earthingset for HeiCase	118
EMC	
– Expansion accessories	146
– Gaskets	146
– Front/rear panels for ventilation	187
– Front panels, handles	166

F

	Page
– Front panels hinged	180
– Contact strip	146
– Rear panels for fan installation	188
– Shielding plate for fans	193
– Seals for mezzanine cut-outs	181
Enclosure	
– for Industrial PCs	208
End pieces	
– for three-part guide rails	157
– for guide rails, aluminium	155
ESD contacts	159
Extractor handle	
– Type I and Type II	168
– Type III	173
Face Plates	226
Fan module	257
Fan mounting plate	186
Fans	
– AC fans	190
– DC fans	191
Feet	
– for HeiCase	120
– for HeiPac Vario-Module	108
Flange 19"	128
Filler Sheets	227
Finger guard	
– for AC/DC fans	192
Filtered IEC mains inlet	257
Front panels	
– for type III extractor handle	173
– for handles type I, II, IV, IVs or VII	166
– for handles type V and VI	176
– with handles type I or II	165
– with handles type V and PCB holder	174
– for ATX power supply	200
– for subracks	165
– to conceal the vertical support	150
Front corner trims	
– for HeiPac Vario-Module	109
Front doot	
– for HeiCase	119
Front flanges	
– for HeiPac Vario-Module	108
Front/rear panels for ventilation	187
Front trim panels for AT/ATX	217

LIST OF TECHNICAL TERMS

S

	Page
Slide rails	
– for HeiCase	116
Side panels	
– for subracks	126
– for HeiPac EASY	127
Side panels and flanges	128
Slim-Box Vario	230
Slotted rear panels	217
Spacers	
– for HeiCase	117
Subracks accessories	
– for subracks	126
– for CPCI- and VME-systeme	257
– for Industrial PCs	
Support spacers	
– for mezzanine cards	181
Support stand/carrying handle	
– for HeiPac Vario-Module	111
Subracks	28
– Individual components	126
– EMC installation	146
– Climate control	186
– HeiPac Vario COMPACT	66
– HeiPac EASY	82
– HeiPac Vario HEAVY	76
– HeiPac Vario	30
– HeiPac Vario EMC	30
– Accessories	125
Mounting kits	150
System enclosures	
– HeiBox	96
– HeiCase	112
– HeiPac Vario-Module	100

T

	Page
Telescopic slides	214
Temperatur- module	256
Temperature sensor	
– For DC-fan	192
Threaded inserts	
– for HeiCase	116
– Threaded inserts (I)	144
Tower-feet for HeiCase	120
Trim frame	
– vented	151
– for horizontal mounting kit	151
Trim section	
– for HeiCase	118
– rear, for HeiPac	57

U

	Page
U-channel front panels	
– for handles type I, II, IV, IVs, or VII	167
– for handles type V and VI	176
– With extractor type I, II or injector / extractor type IV	166
Universal holder	
– for front panel support	174
Unused slot cover	214

V

	Page
Vario, HeiPac	30
Vario, HeiPac EMV	30
Vario-Modulea, HeiPac	100
Vertical divider kit	150
Vertical support	150
VME J1 system bus	254
VME J2 expansion bus	254
VMEbus	
– Backplanes	252
– Backplanes, technical specifications	250
– Rack-mount systems	244
– MPS Monitoring	255
– Accessories	257

Z

	Page
Z rail for connector	144

WEITERE INFORMTIONEN UNTER
WWW.HEITEC.DE

A blurred photograph of a modern office hallway with large windows and people walking. The image is used as a background for the advertisement.

WE MEET YOUR INDIVIDUAL NEEDS!

You are looking for a product in the field of electronic packaging that is not in our catalogue?

Please contact us!

We will gladly submit a tailored quotation.

Phone: 09126 - 29 34 0

E-Mail: eps-quote@heitec.de

HEITEC – WE CREATE YOUR ELECTRONIC WORLD



See our website for contact details of our sales partners.

HEITEC AG

Dr.-Otto-Leich-Straße 16
90542 Eckental

Phone: +49 9126 2934 0

Fax: +49 9126 2934 199

E-Mail: electronics@heitec.de

Internet: www.heitec-eps.com